



US00D491315S

(12) **United States Design Patent**
Dittmer et al.

(10) **Patent No.:** **US D491,315 S**

(45) **Date of Patent:** **** Jun. 8, 2004**

(54) **COMPACT**

(75) Inventors: **Jay R. Dittmer**, Ada, MI (US); **Mark F. Mettler**, Spring Lake, MI (US)

(73) Assignee: **Access Business Group International LLC**, Ada, MI (US)

(**) Term: **14 Years**

(21) Appl. No.: **29/186,934**

(22) Filed: **Jul. 24, 2003**

(51) **LOC (7) Cl.** **28-03**

(52) **U.S. Cl.** **D28/83**

(58) **Field of Search** D28/76, 78, 83,
D28/91; 132/287, 293–307, 314–316; 220/DIG. 26;
248/581, 823

(56) **References Cited**

U.S. PATENT DOCUMENTS

3,776,245	A	*	12/1973	Hayes et al.	132/304
D267,983	S	*	2/1983	Cheung	D28/83
D338,279	S	*	8/1993	Davis	D28/83
5,437,294	A	*	8/1995	Ebbets et al.	132/304

D433,539	S	11/2000	Gavin
D433,773	S	11/2000	Gavin
D434,875	S	12/2000	Gavin
D468,058	S	12/2002	Thorpe

* cited by examiner

Primary Examiner—Jennifer Rivard

(74) *Attorney, Agent, or Firm*—Warner Norcross & Judd LLP

(57) **CLAIM**

The ornamental design for compact, as shown and described.

DESCRIPTION

FIG. 1 is a perspective view of the compact embodying the new design;
FIG. 2 is a top plan view thereof;
FIG. 3 is a bottom plan view thereof;
FIG. 4 is a front elevational view thereof;
FIG. 5 is a rear elevational view thereof; and,
FIG. 6 is a left side elevational view thereof, the right side elevational view being a mirror image thereof.

1 Claim, 6 Drawing Sheets

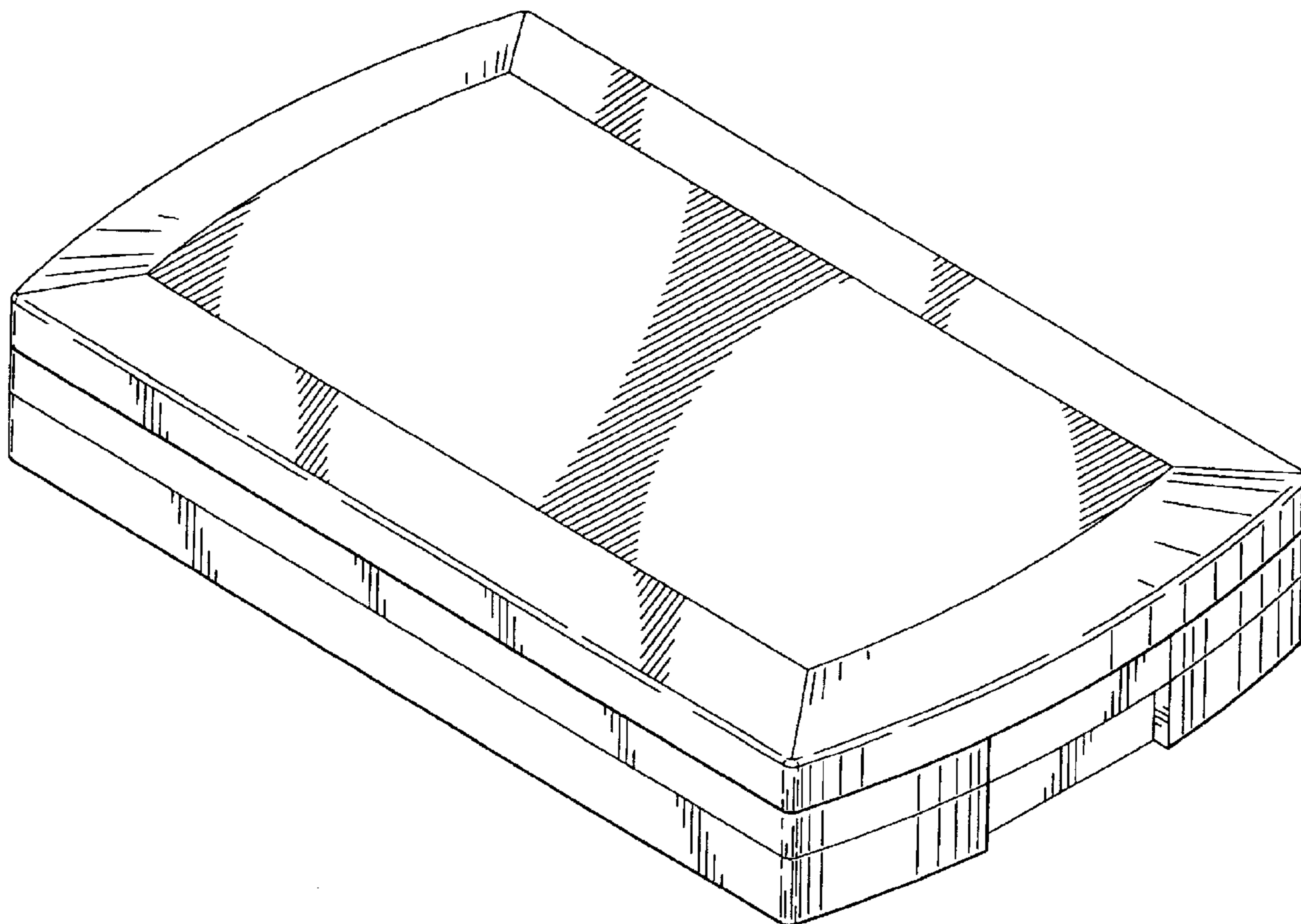

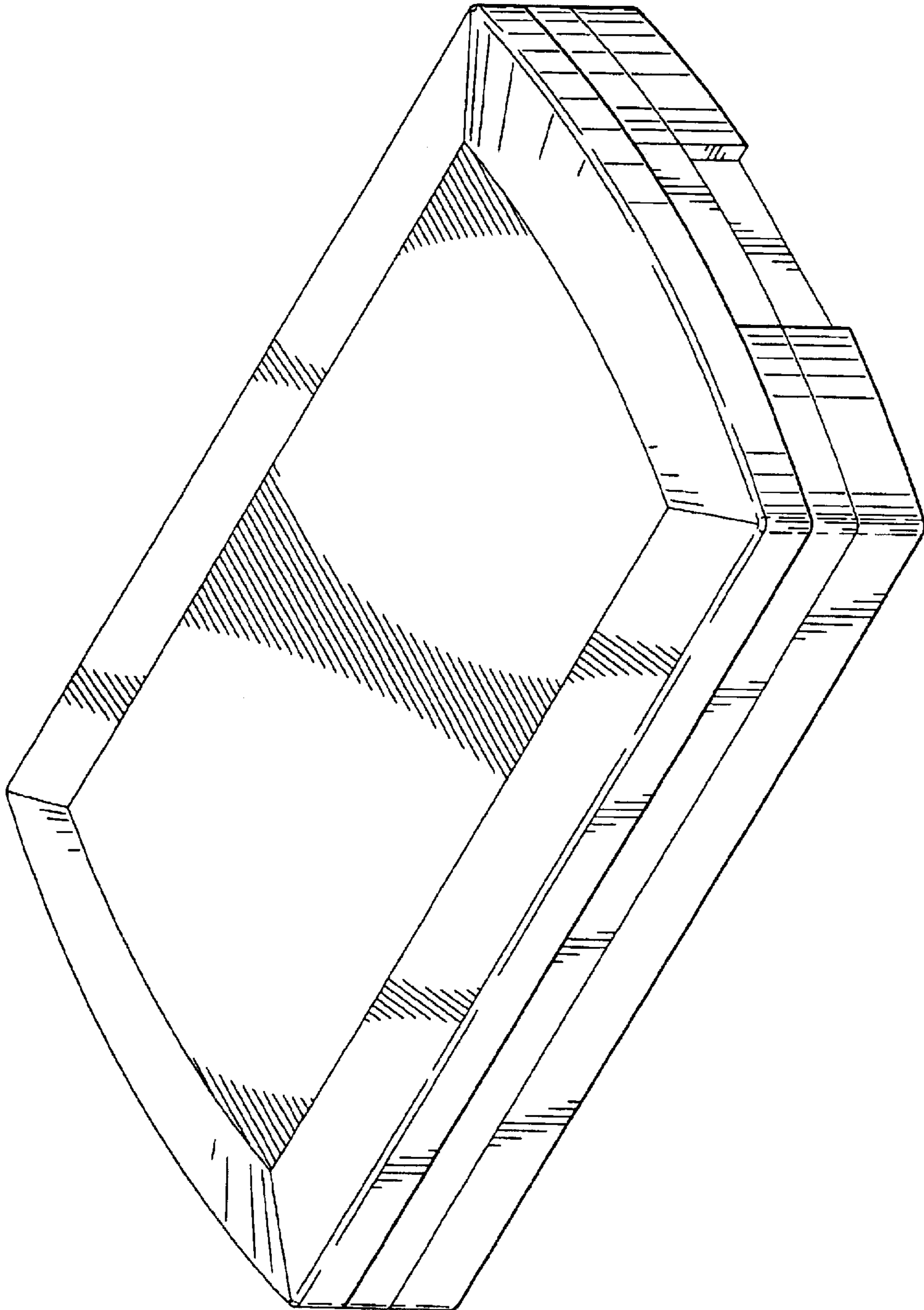

FIG. 1

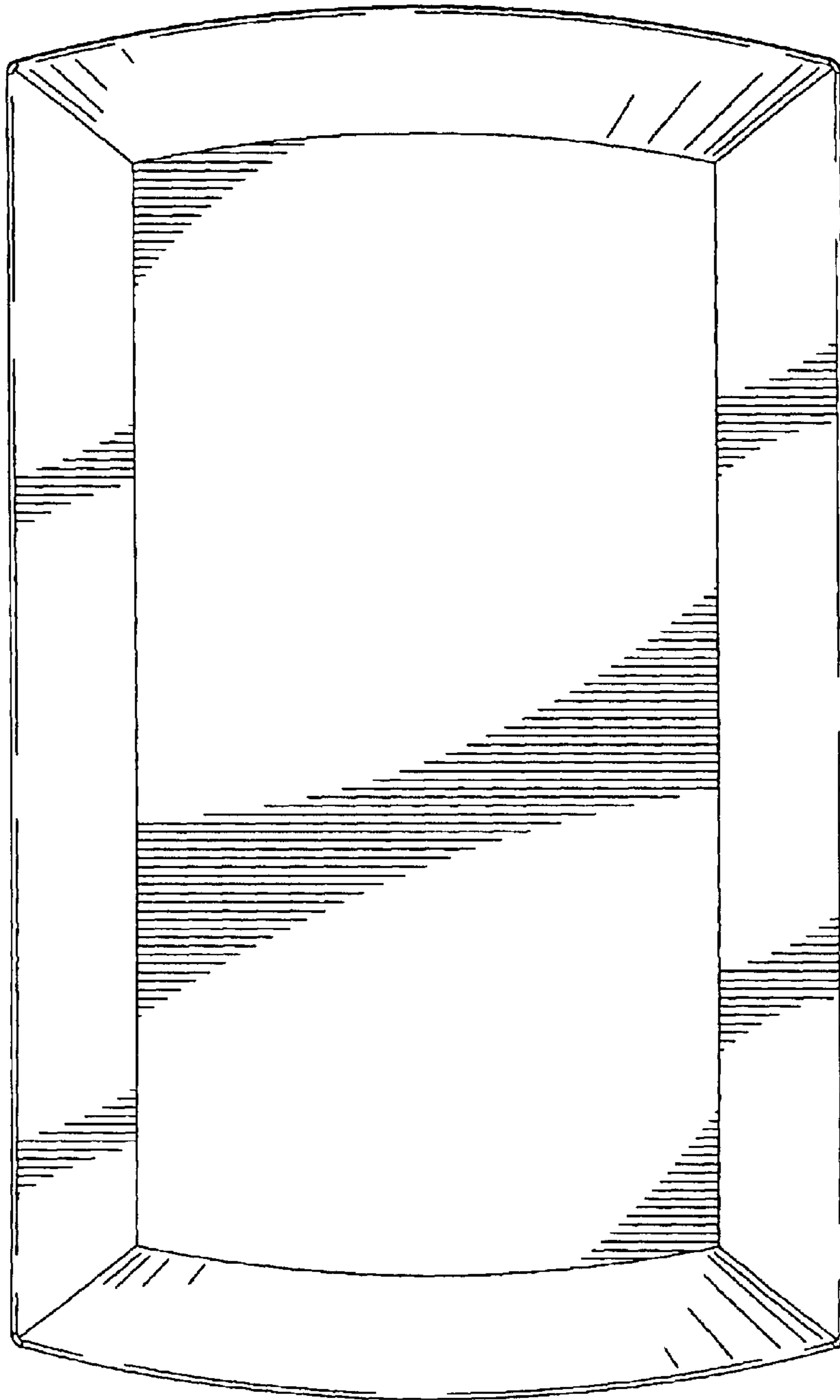

FIG. 2

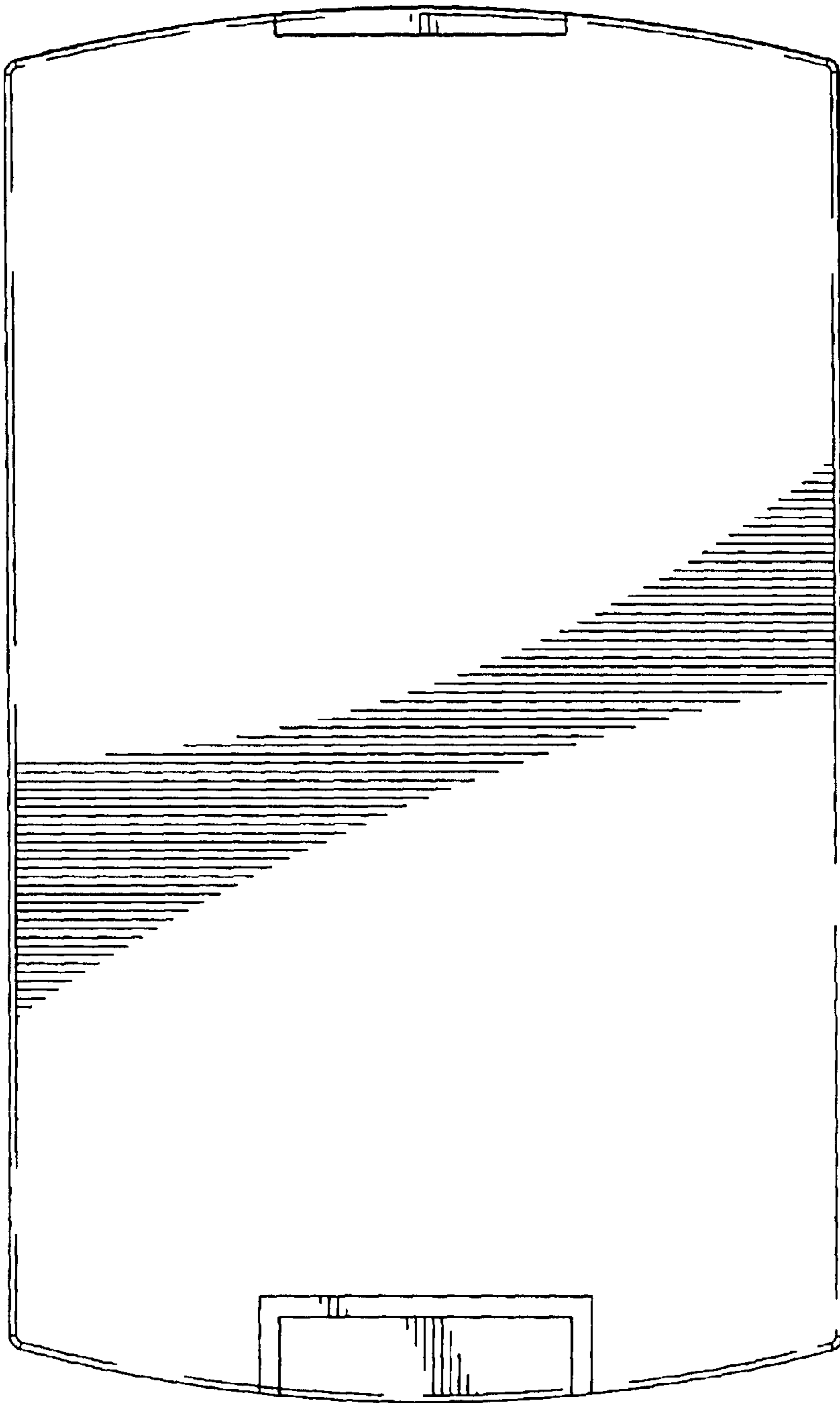

FIG. 3

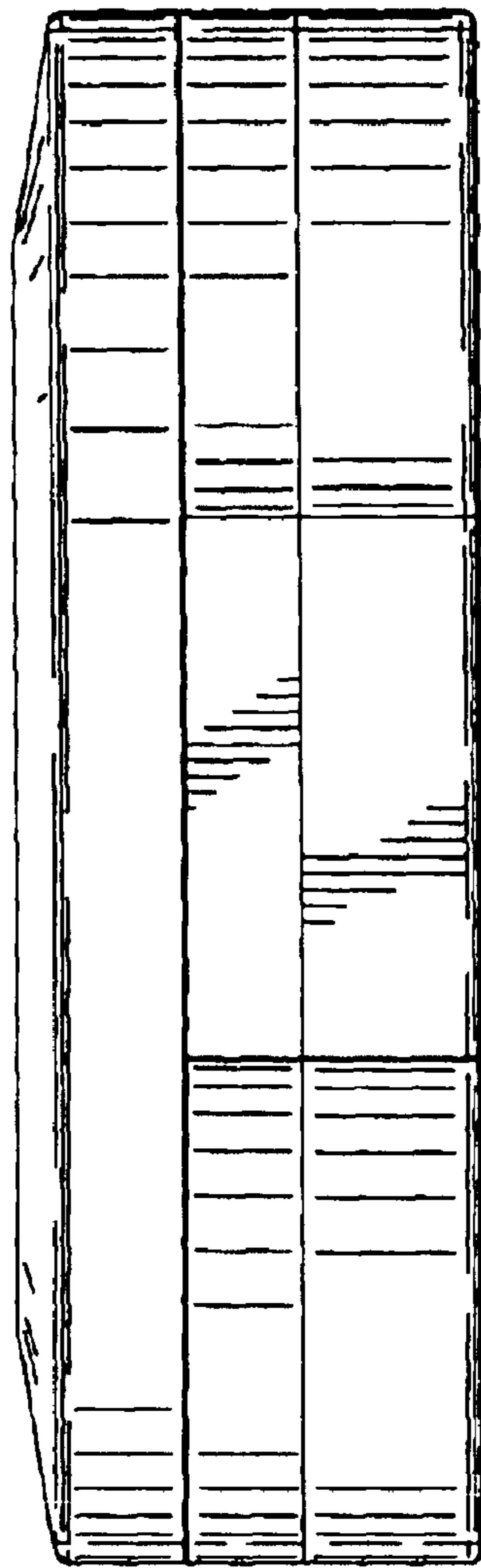

FIG. 4

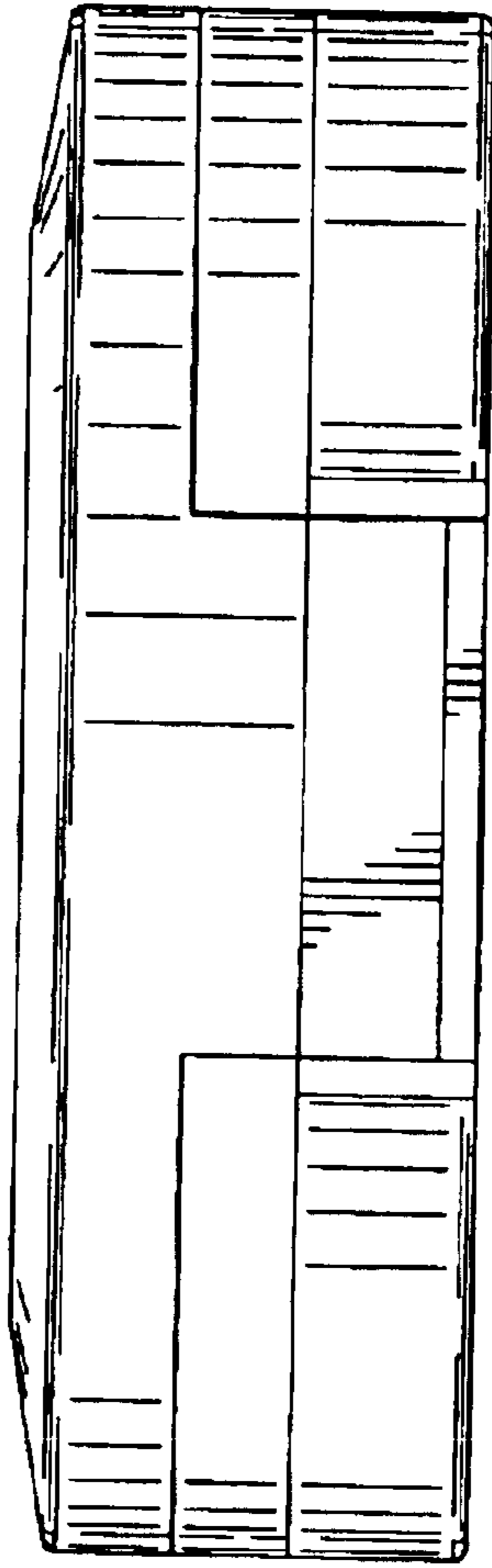

FIG. 5

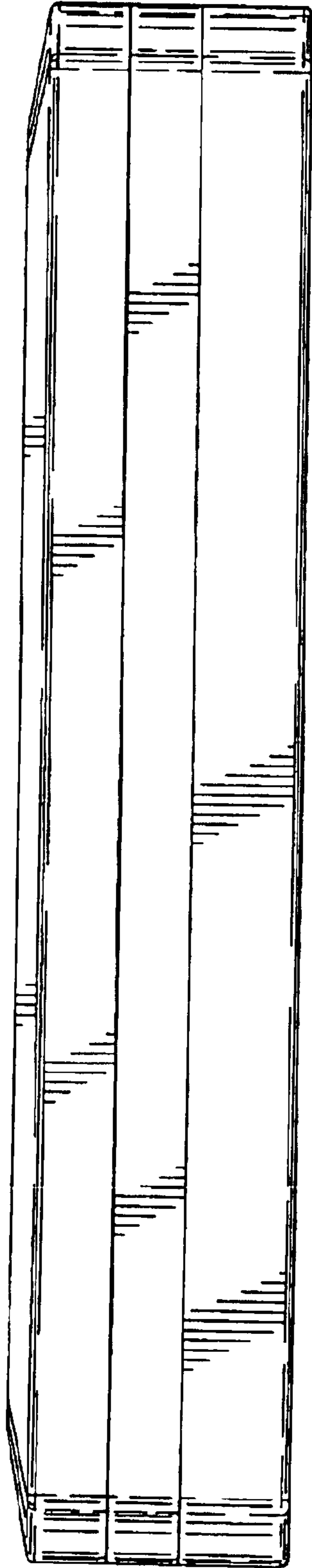

FIG. 6