



US00D491301S

(12) **United States Design Patent**
Chen

(10) **Patent No.:** **US D491,301 S**

(45) **Date of Patent:** **** Jun. 8, 2004**

(54) **HAND LIGHT**

D445,926 S * 7/2001 Cheong D26/37

(76) Inventor: **Chung-Yang M. Chen**, 3F, No.2, Lane
497, Chung-Cheng Rd., Hsintien City,
Taipei County (TW)

* cited by examiner

Primary Examiner—Marcus A. Jackson
(74) *Attorney, Agent, or Firm*—Troxell Law Office PLLC

(**) Term: **14 Years**

(57) **CLAIM**

(21) Appl. No.: **29/190,176**

The ornamental design for hand light, shown and described.

(22) Filed: **Sep. 17, 2003**

DESCRIPTION

(51) **LOC (7) Cl.** **26-02**

(52) **U.S. Cl.** **D26/37**

(58) **Field of Search** D26/37-50; 362/157,
362/158, 171-173, 183-208

FIG. 1 is a front side perspective view showing our new
design for hand light;

FIG. 2 is a front elevational view thereof;

FIG. 3 is a rear elevational view thereof;

FIG. 4 is a left side elevational view thereof;

FIG. 5 is a right side elevational view thereof;

FIG. 6 is a top view thereof; and,

FIG. 7 is a bottom view thereof.

(56) **References Cited**

U.S. PATENT DOCUMENTS

D403,450 S * 12/1998 Ting D26/37

D429,831 S * 8/2000 Ting D26/37

D443,705 S * 6/2001 Sanders D26/37

1 Claim, 4 Drawing Sheets

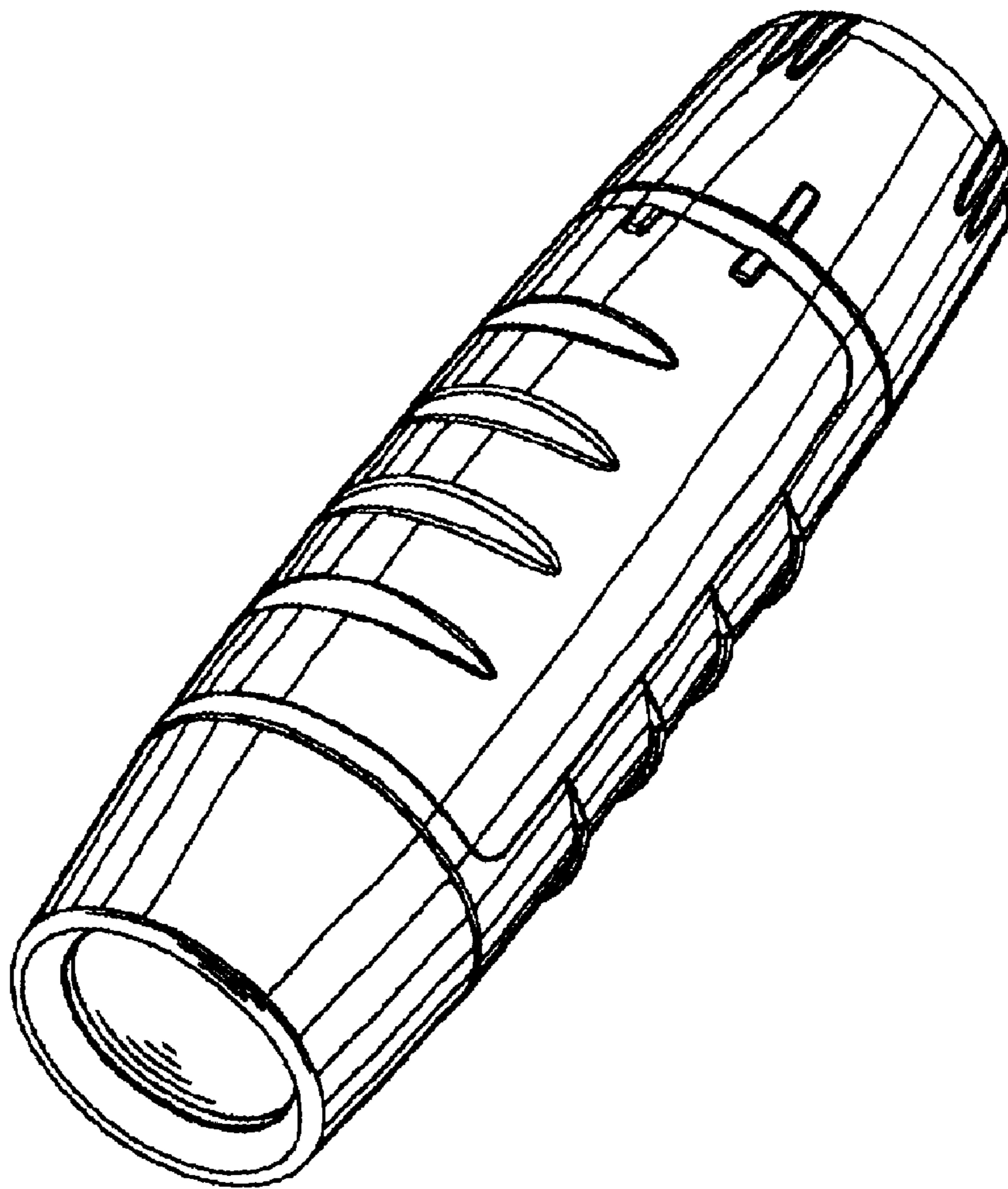

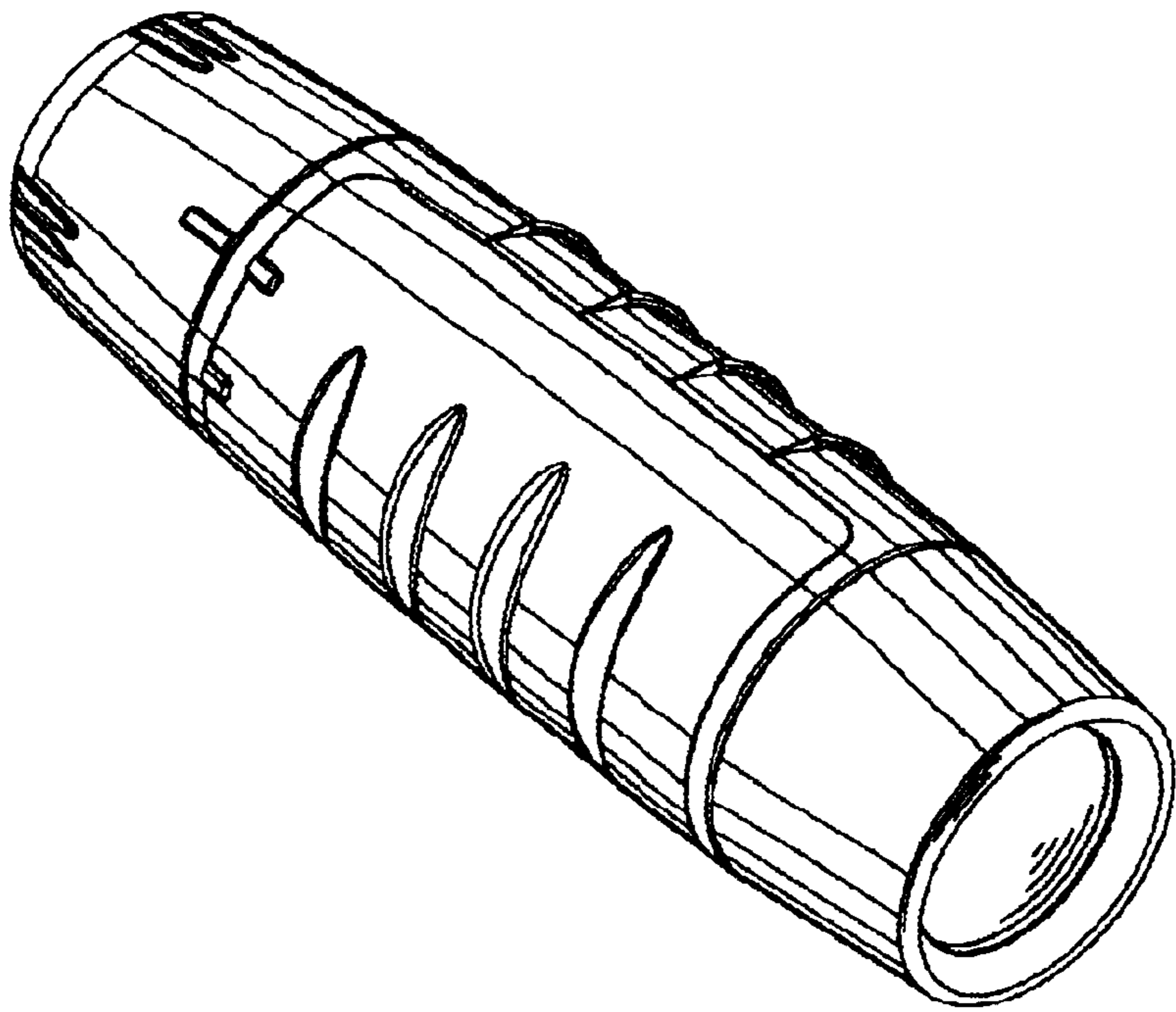

Fig. 1

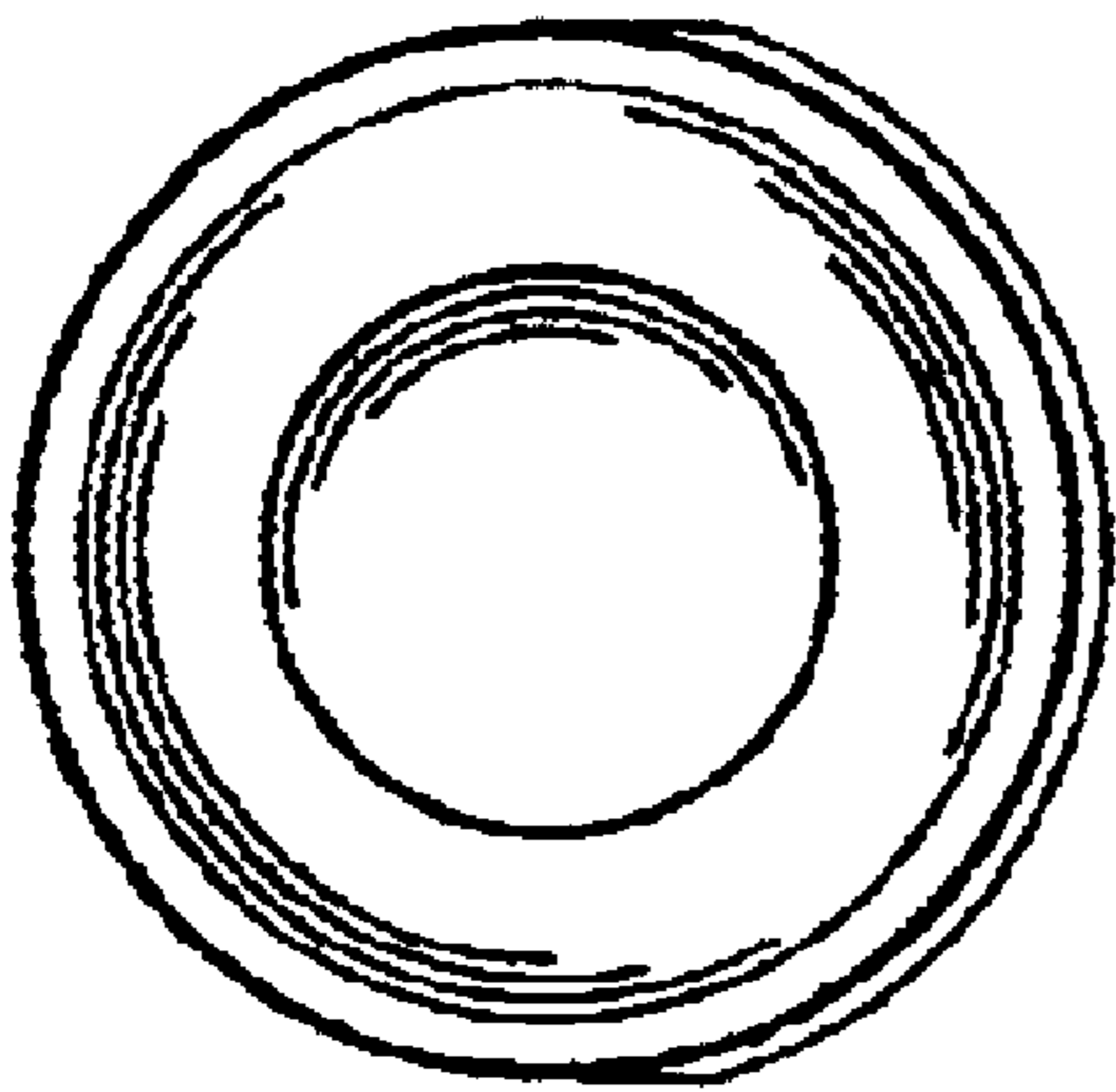

Fig. 2

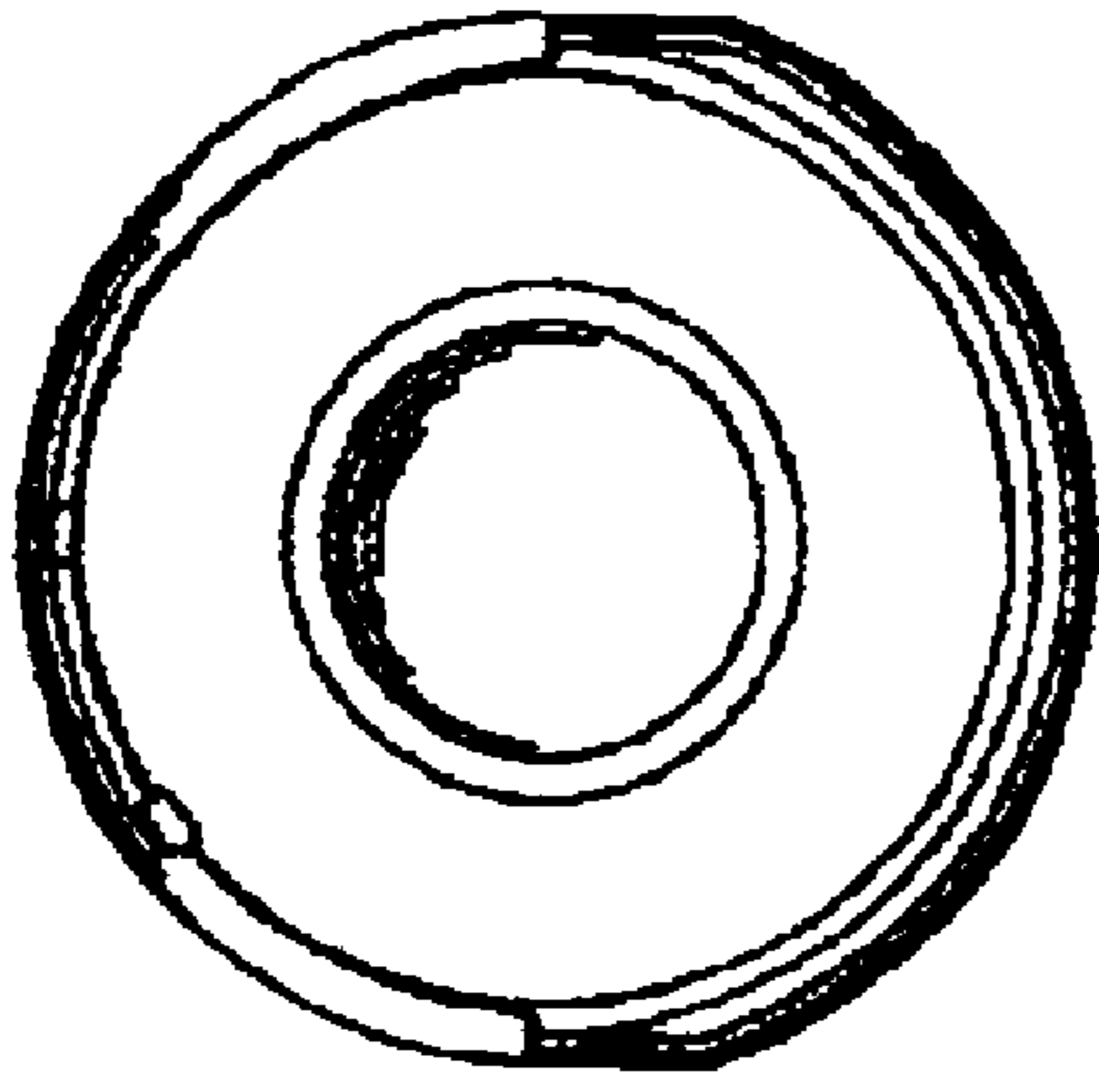

Fig. 3

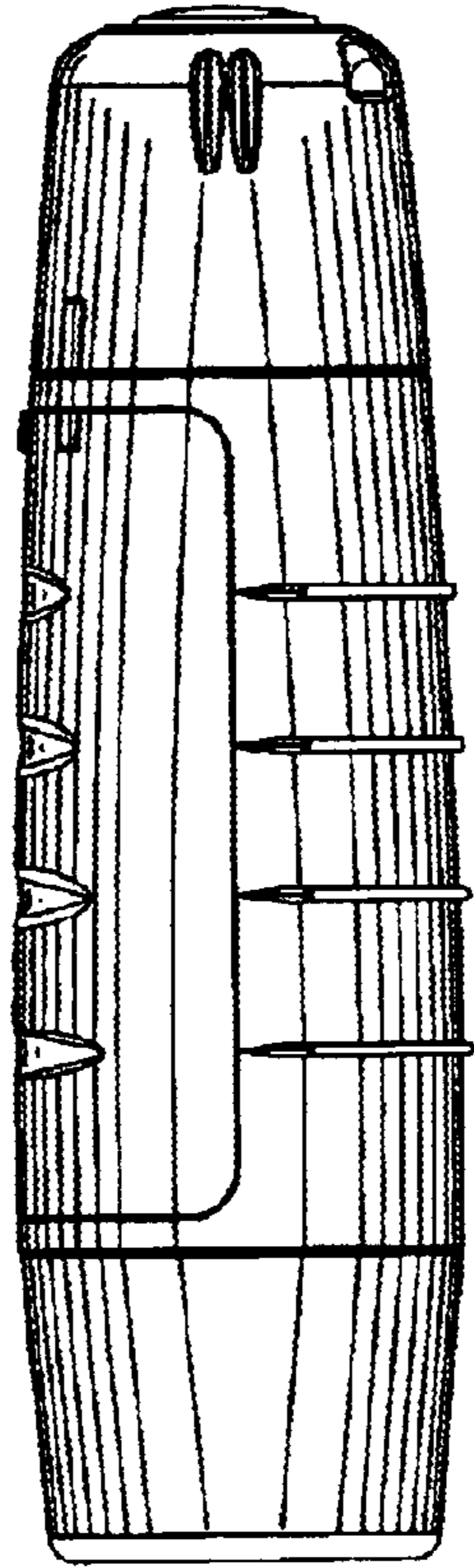

Fig. 5



Fig. 4

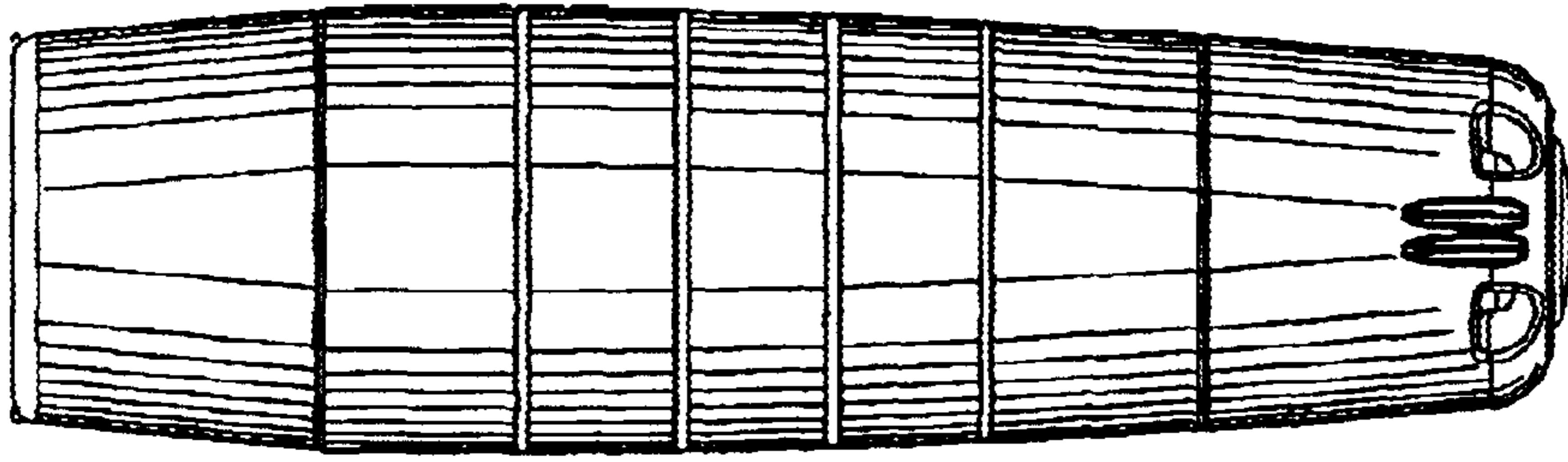

Fig. 7

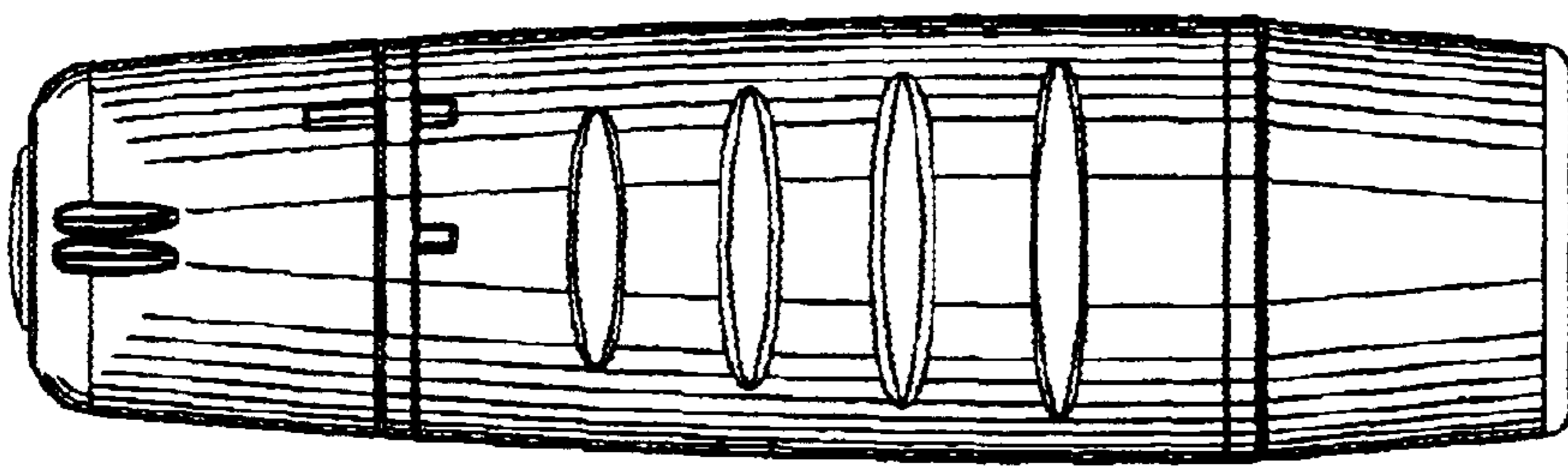

Fig. 6