



US00D491101S

(12) **United States Design Patent**  
**Hsu**

(10) **Patent No.:** **US D491,101 S**

(45) **Date of Patent:** **\*\* Jun. 8, 2004**

(54) **SHOULDER-STRAP CLIP FOR A BRASSIERE**

D415,067 S \* 10/1999 Tung ..... D11/200

\* cited by examiner

(76) Inventor: **Yu-Li Hsu**, 11F-1, No. 9-7, Sec. 2,  
Taichungkang Rd., Taichung (TW)

*Primary Examiner*—Ralf Seifert

(74) *Attorney, Agent, or Firm*—Bacon & Thomas, PLC

(\*\*) Term: **14 Years**

(57) **CLAIM**

(21) Appl. No.: **29/188,344**

The ornamental design for a shoulder-strap clip for a brassiere, as shown and described.

(22) Filed: **Aug. 19, 2003**

**DESCRIPTION**

(51) **LOC (7) Cl.** ..... **02-07**

FIG. 1 is a perspective view of a shoulder-strap clip for a brassiere, showing my new design;

(52) **U.S. Cl.** ..... **D11/210**

FIG. 2 is a front elevational view thereof;

(58) **Field of Search** ..... D11/200, 201,

FIG. 3 is a rear elevational view thereof;

D11/208–210, 212–218, 220, 231–234,

FIG. 4 is a left elevational view thereof;

237, 86–87, 94; 63/15.2, 15; 24/307, 625,

FIG. 5 is a right elevational view thereof;

616, 200, 196, 171, 169, 112

FIG. 6 is top plan view thereof;

(56) **References Cited**

FIG. 7 is a bottom plan view thereof; and,

**U.S. PATENT DOCUMENTS**

FIG. 8 is a perspective view showing an embodiment of the claimed design, wherein the broken lines are shown for illustrative purposes only and form no part of the claimed design.

D176,378 S \* 12/1955 Paulson ..... D11/208

D263,260 S \* 3/1982 Heil ..... D11/210

D316,956 S \* 5/1991 Hoskinson et al. .... D8/371

D385,825 S \* 11/1997 Johnson, III ..... D11/212

**1 Claim, 8 Drawing Sheets**

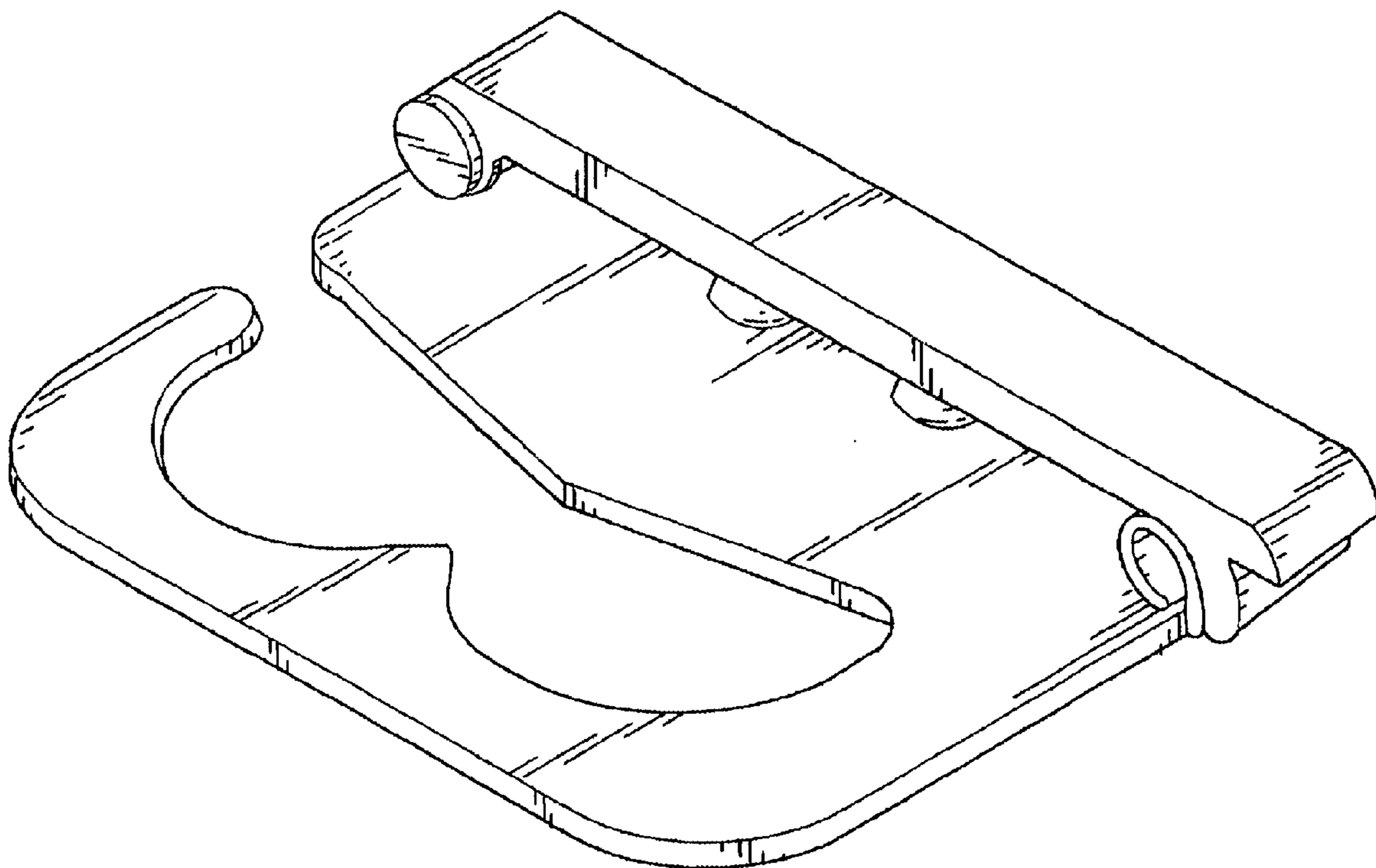

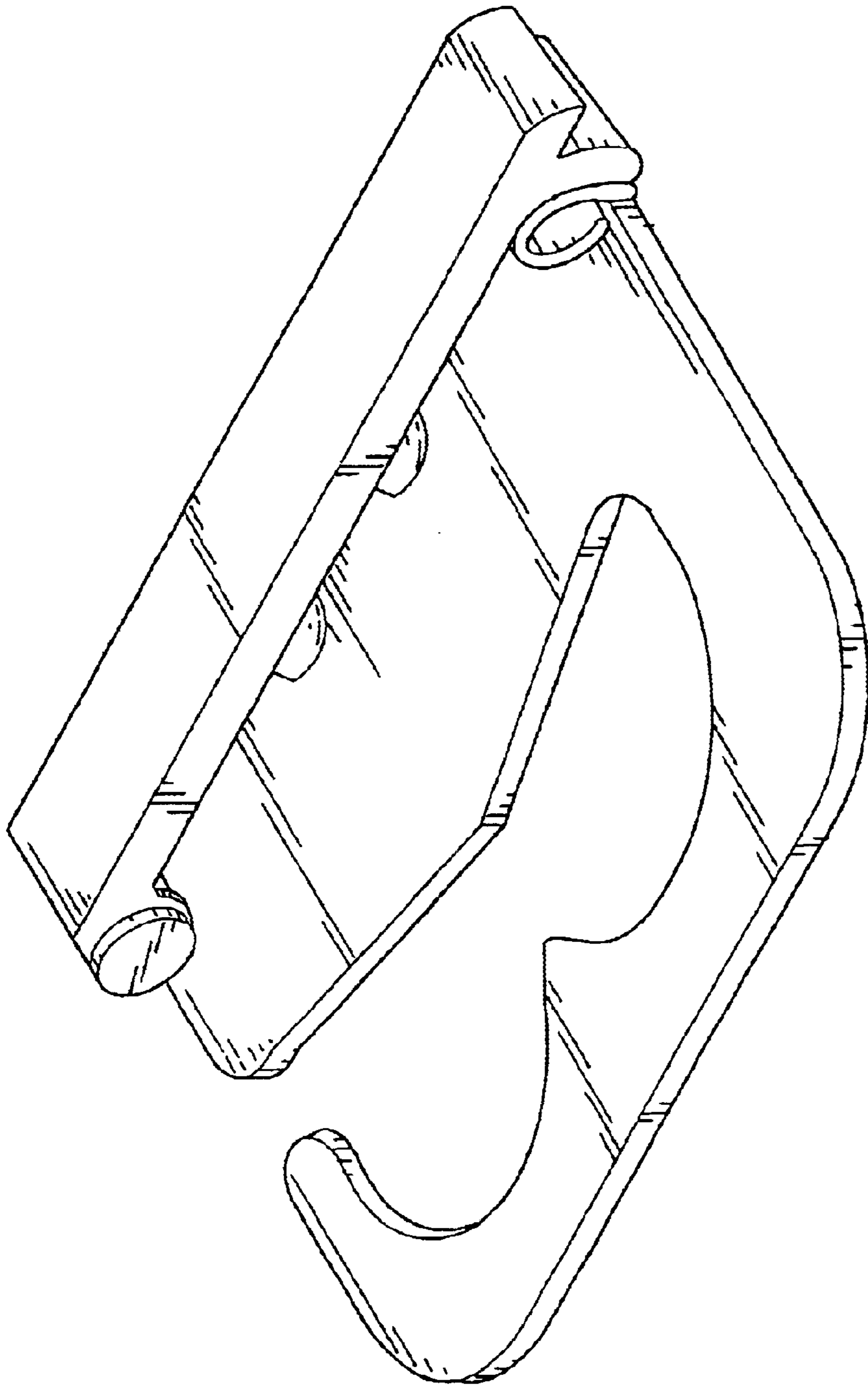

FIG.1

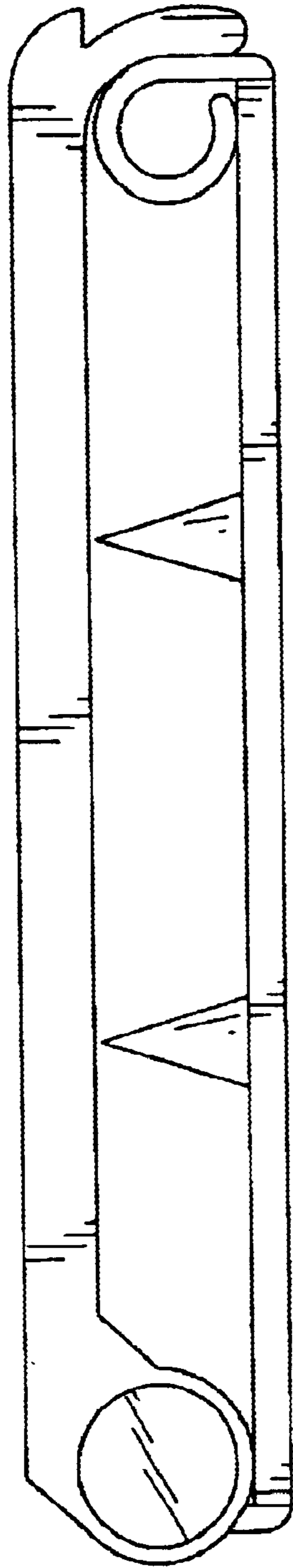

FIG.2

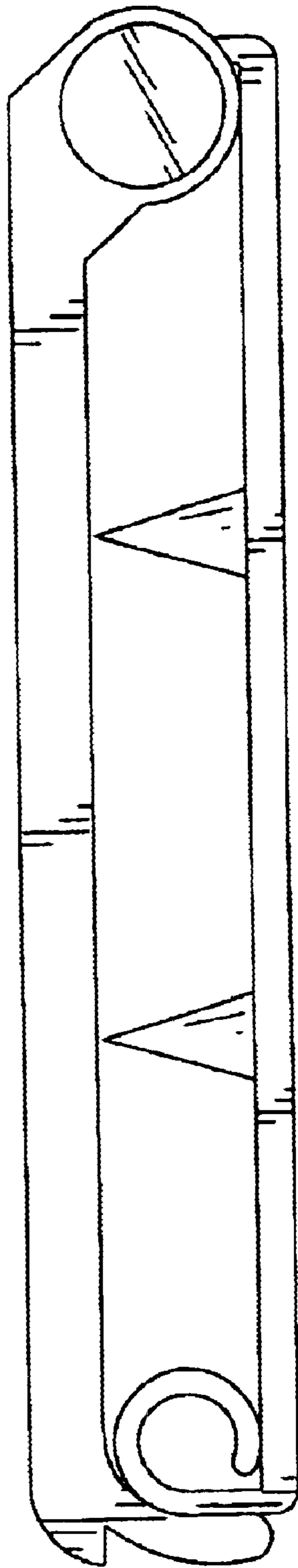

FIG. 3

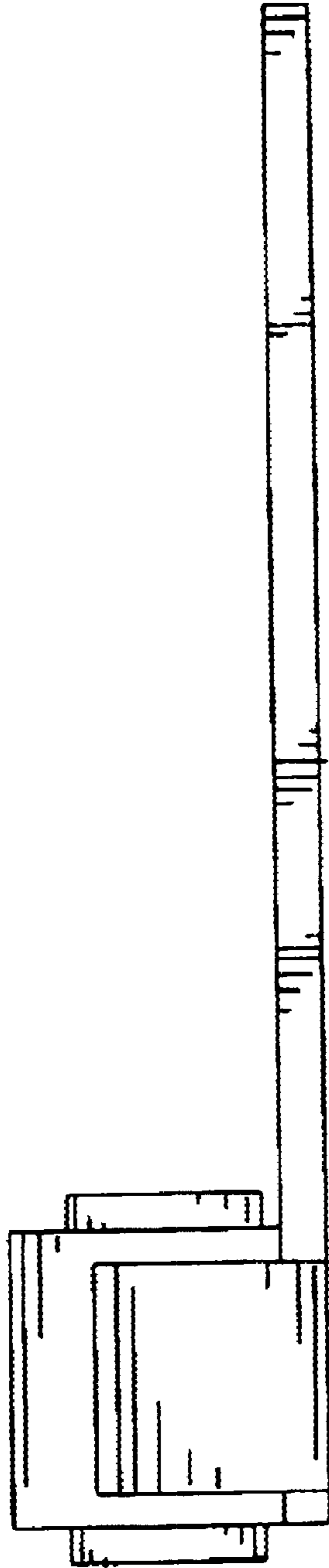

FIG. 4

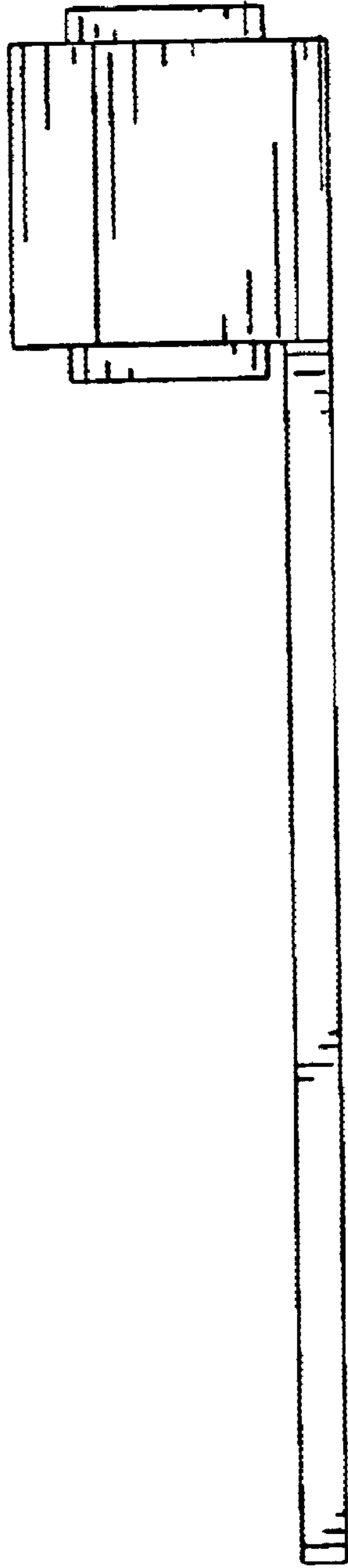

FIG. 5

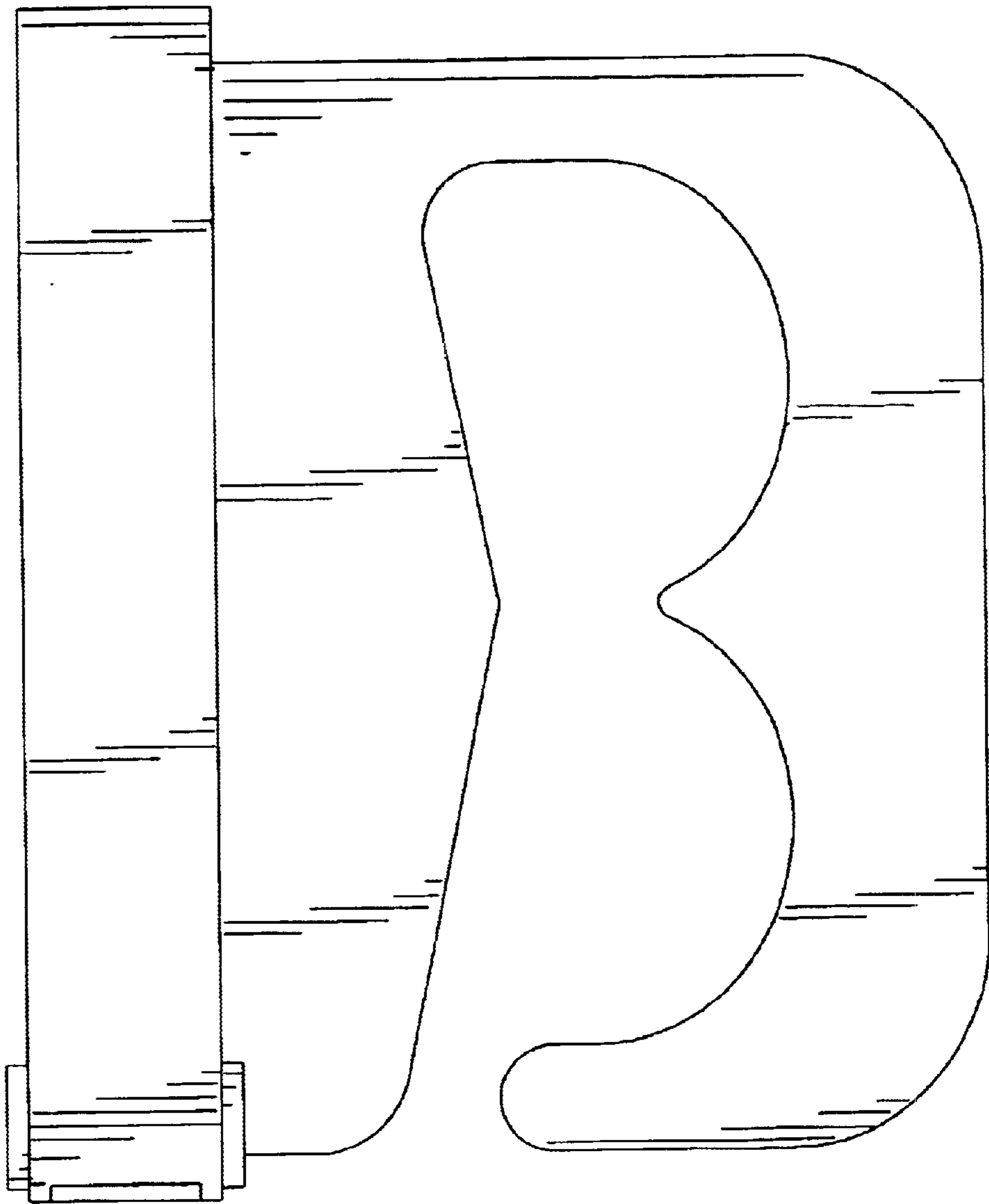

FIG.6

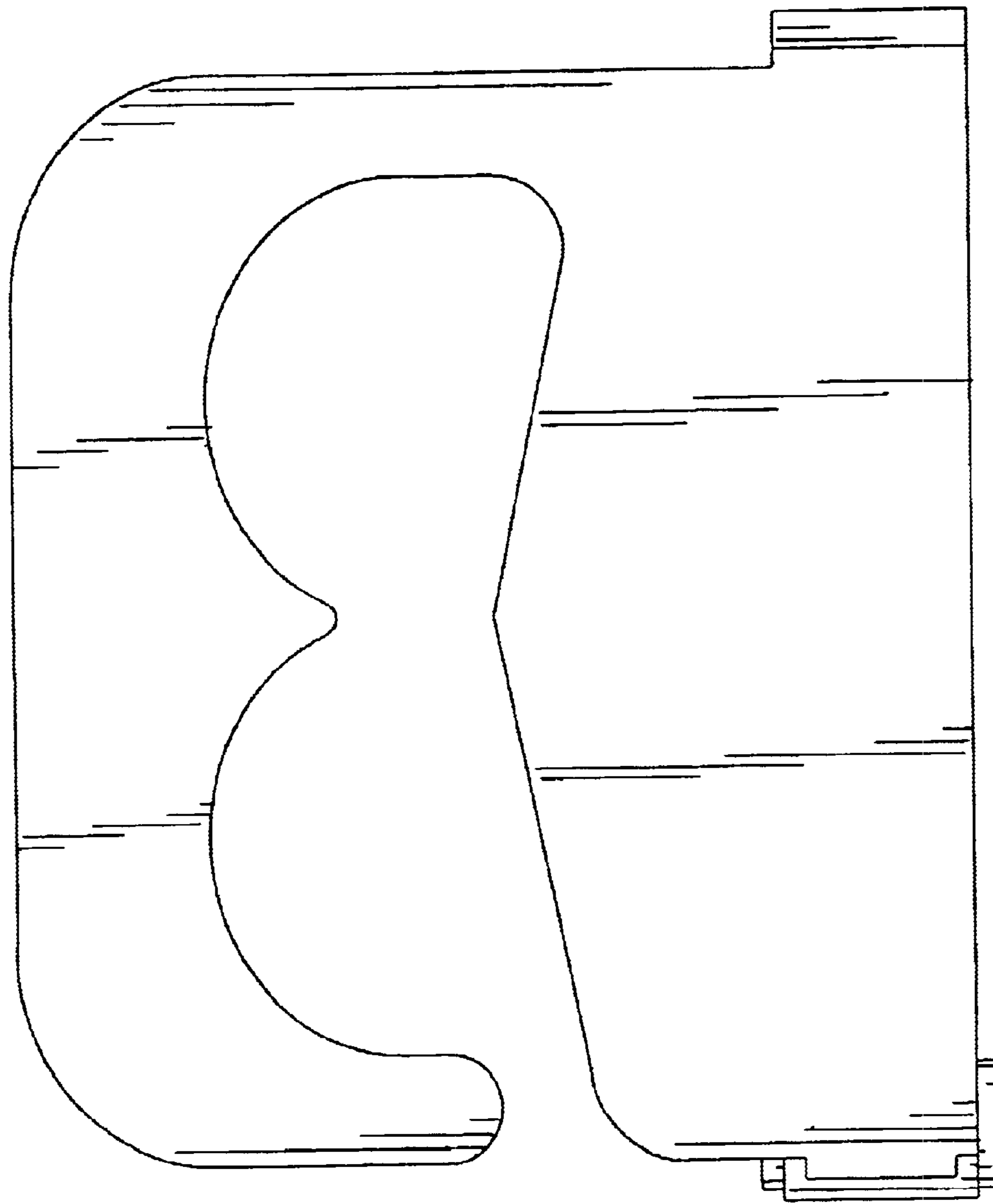

FIG. 7



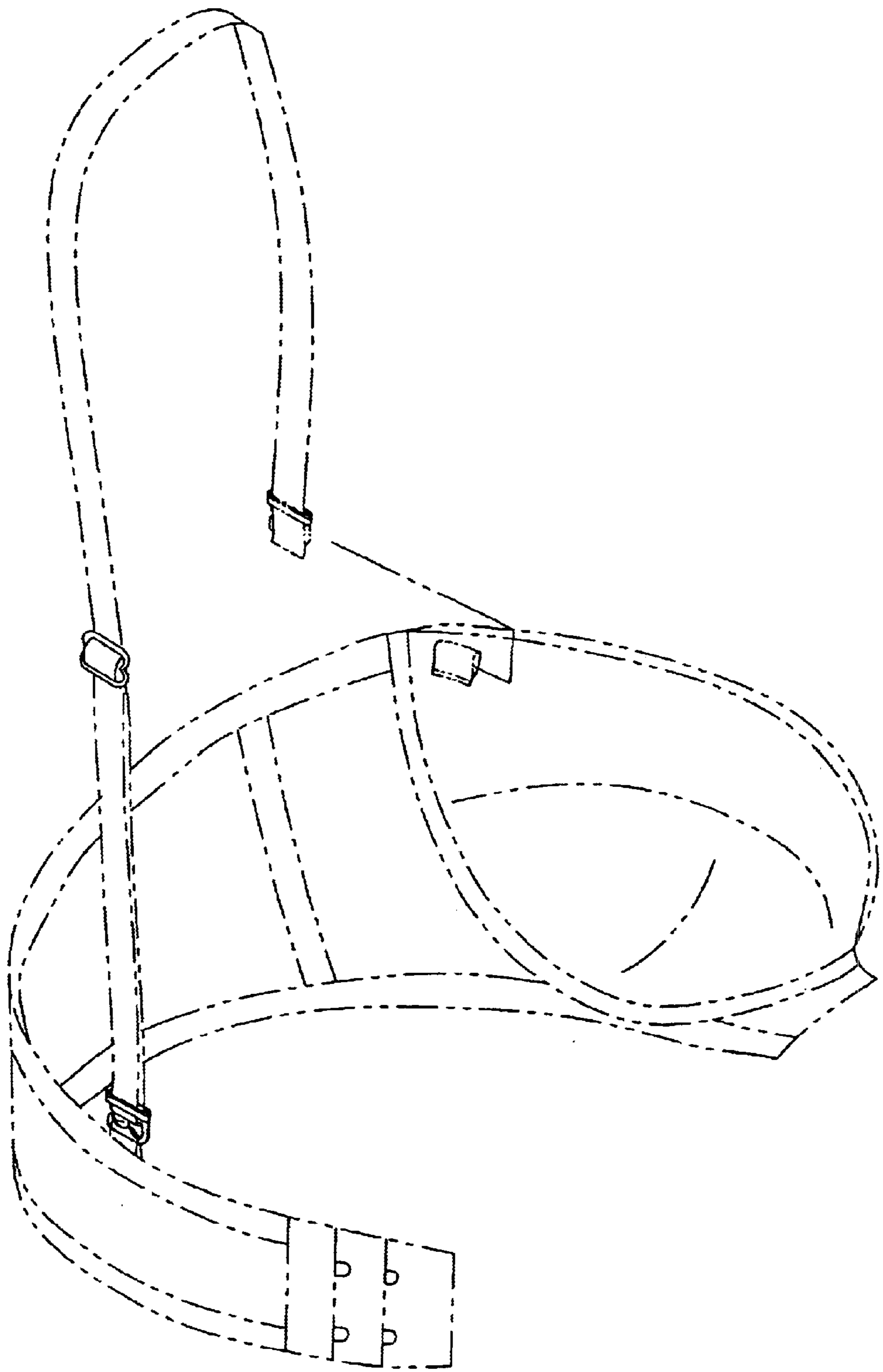

FIG. 8