



US00D491045S

(12) **United States Design Patent**
Laabs et al.

(10) **Patent No.: US D491,045 S**
(45) **Date of Patent: ** Jun. 8, 2004**

(54) **RETAINING CLIP FOR CAM LOCK**
(75) Inventors: **Timothy P. Laabs**, Palatine, IL (US);
Thomas Heinrich, Streamwood, IL (US)
(73) Assignee: **The Eastern Company**, Wheeling, IL (US)
(**) Term: **14 Years**
(21) Appl. No.: **29/185,975**
(22) Filed: **Jul. 7, 2003**

3,503,233 A	3/1970	Russell et al.	70/370
3,604,230 A	9/1971	Tixier	70/181
3,842,709 A	10/1974	Fuqua	85/5
4,080,522 A	3/1978	Schimmels	200/295
4,128,923 A	* 12/1978	Bisbing	411/552
4,363,230 A	12/1982	Lipschutz	70/370
4,586,354 A	5/1986	Smith	70/451
4,873,852 A	* 10/1989	Neyret	70/451
4,890,467 A	* 1/1990	Krause et al.	70/369
4,910,982 A	3/1990	Dana	70/370
4,951,980 A	8/1990	Wetzel	292/202
5,249,443 A	10/1993	Anderson	70/370
5,251,467 A	10/1993	Anderson	70/370

(List continued on next page.)

Related U.S. Application Data

(62) Division of application No. 29/161,088, filed on May 22, 2002, now Pat. No. Des. 482,596.
(51) **LOC (7) Cl.** **08-02**
(52) **U.S. Cl.** **D8/343**
(58) **Field of Search** D8/330, 331, 336, D8/338, 343; 70/353, 360, 365, 370, 372, 373; 292/251.1, 202, 295, 292, 289

OTHER PUBLICATIONS

British Patent 1518334 Published Jul. 1978.
German Patent 4006706 Published Sep. 1991.

Primary Examiner—Prabhakar Deshmukh
(74) *Attorney, Agent, or Firm*—David A. Burge

(57) **CLAIM**

The ornamental design for retaining clip for cam lock, as shown and described.

(56) **References Cited**

U.S. PATENT DOCUMENTS

1,400,155 A	10/1921	Greenburg	40/663
1,470,858 A	10/1923	Maxwell	70/370
1,561,254 A	11/1925	Ledin	70/370
2,093,038 A	9/1937	Douglas	248/27
2,140,441 A	12/1938	Clark	248/27
2,244,976 A	6/1941	Tinnerman	70/370
RE22,544 E	9/1944	Tinnerman	411/522
2,424,757 A	7/1947	Klumpp, Jr.	174/153
2,558,852 A	7/1951	Jacobi	70/451
2,580,548 A	1/1952	Jacobi	70/370
2,629,248 A	2/1953	Burdick	70/370
2,632,615 A	3/1953	Churchill	248/27
2,633,011 A	3/1953	Poupitch	70/370
2,744,185 A	5/1956	Cawley	240/2
2,745,275 A	5/1956	Jacobi	70/370
3,079,581 A	2/1963	Klumpp, Jr.	339/128
3,190,092 A	6/1965	Patriquin	70/370
3,425,729 A	2/1969	Bisbing	292/251.5

DESCRIPTION

FIG. 1 is a front and right side perspective view of a retaining clip for cam lock showing our design;
FIG. 2 is a front and left side perspective view thereof;
FIG. 3 is a front elevational view thereof;
FIG. 4 is a rear elevational view thereof;
FIG. 5 is a right side elevational view thereof;
FIG. 6 is a left side elevational view thereof;
FIG. 7 is a top plan view thereof; the bottom plan view being a mirror image thereof;
FIG. 8 is a perspective view thereof; similar to FIG. 1 with the lock shown in broken lines;
FIG. 9 is a right side elevational view of FIG. 8; and,
FIG. 10 is a left side elevational view of FIG. 8.
The broken lines are for illustrative purposes only and form no part of the claimed design.

1 Claim, 3 Drawing Sheets

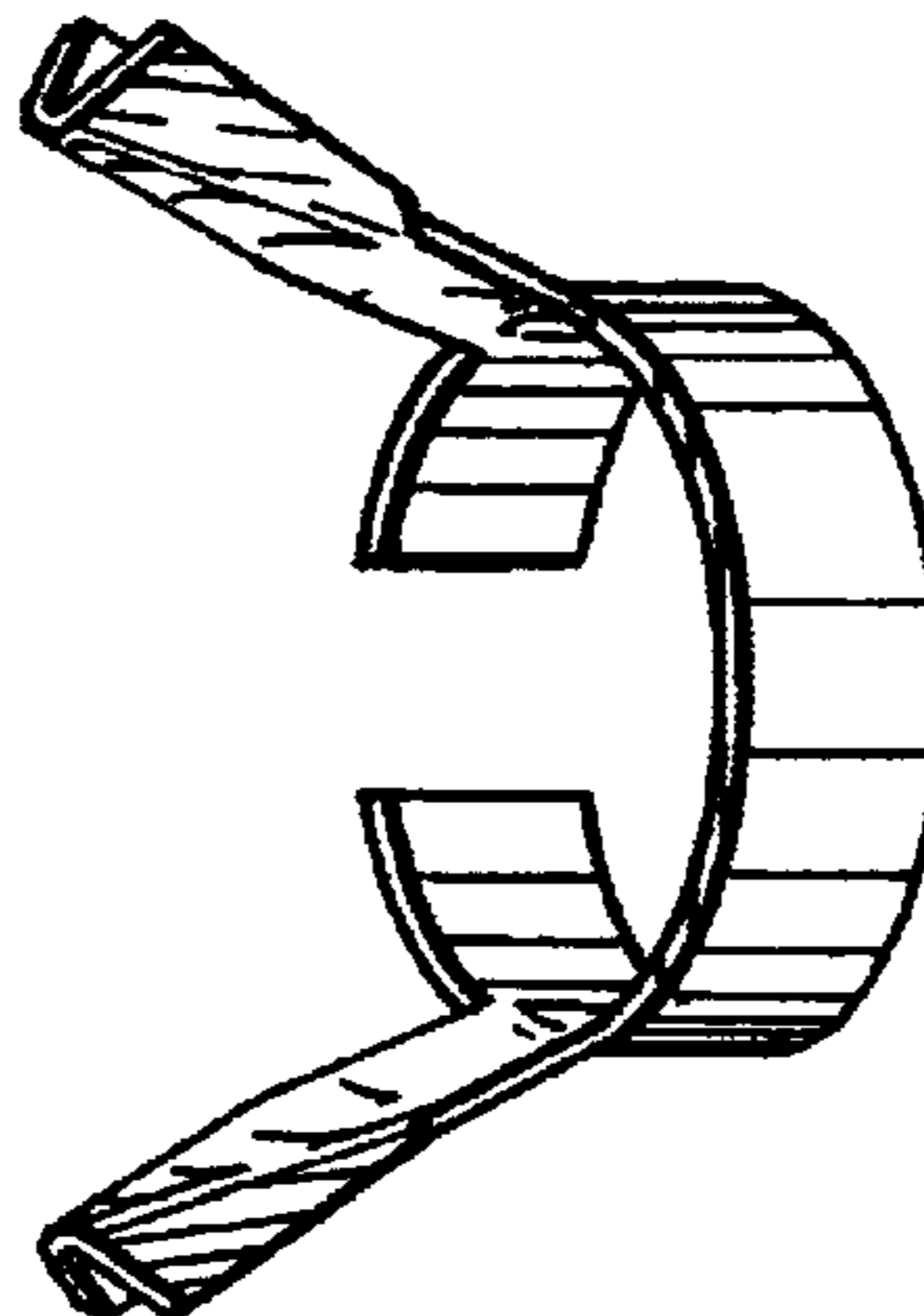

US D491,045 S

Page 2

U.S. PATENT DOCUMENTS			
5,435,159 A	7/1995	Ramsauer	70/370
5,479,800 A	1/1996	Myers	70/365
5,669,731 A	9/1997	Hironaka et al.	403/405.1
6,161,404 A	12/2000	Westwinkel	70/370
D469,680 S	* 2/2003	Laabs et al.	D8/343
D474,098 S	* 5/2003	Weinerman et al.	D8/330

* cited by examiner

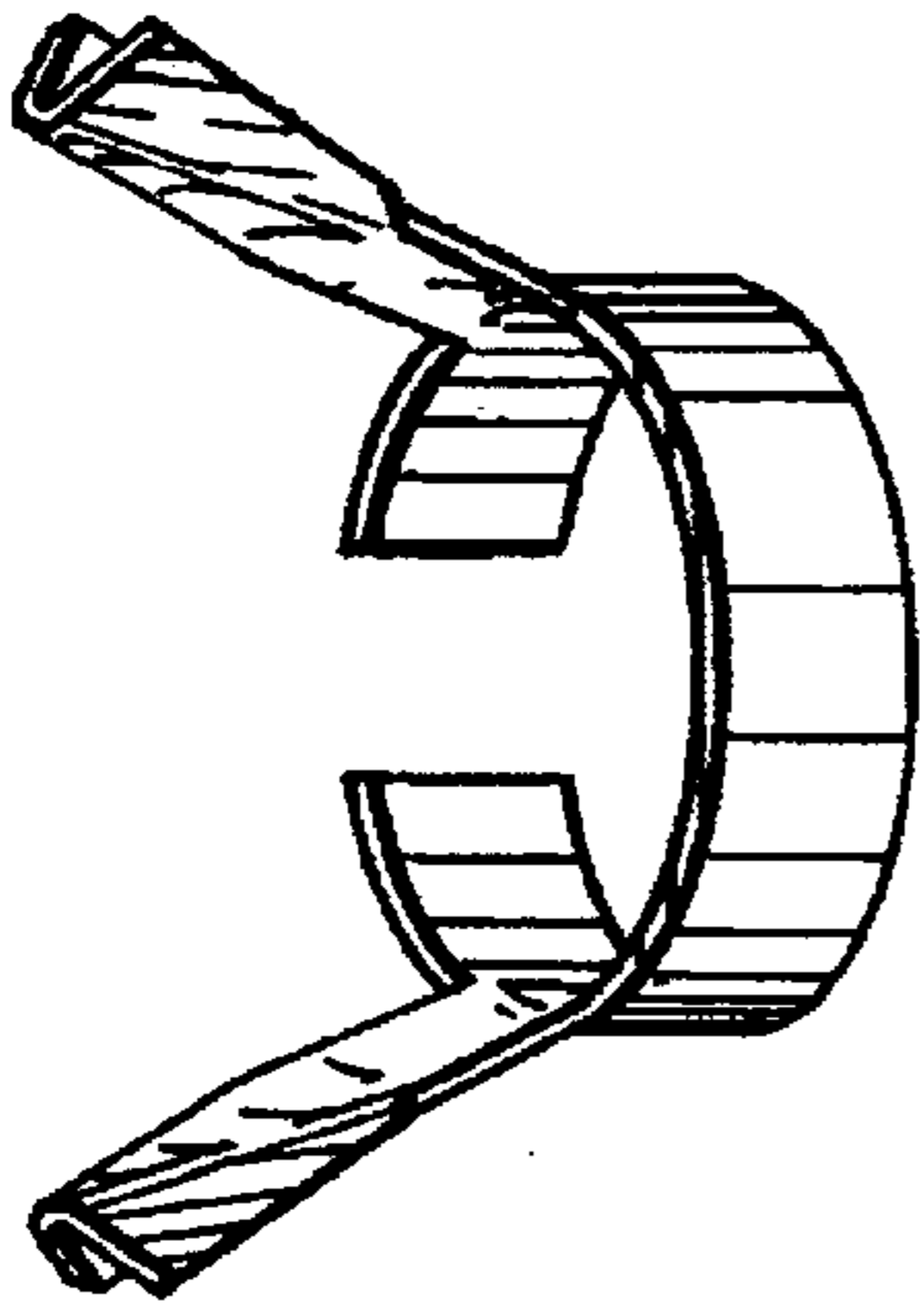

FIG. 1

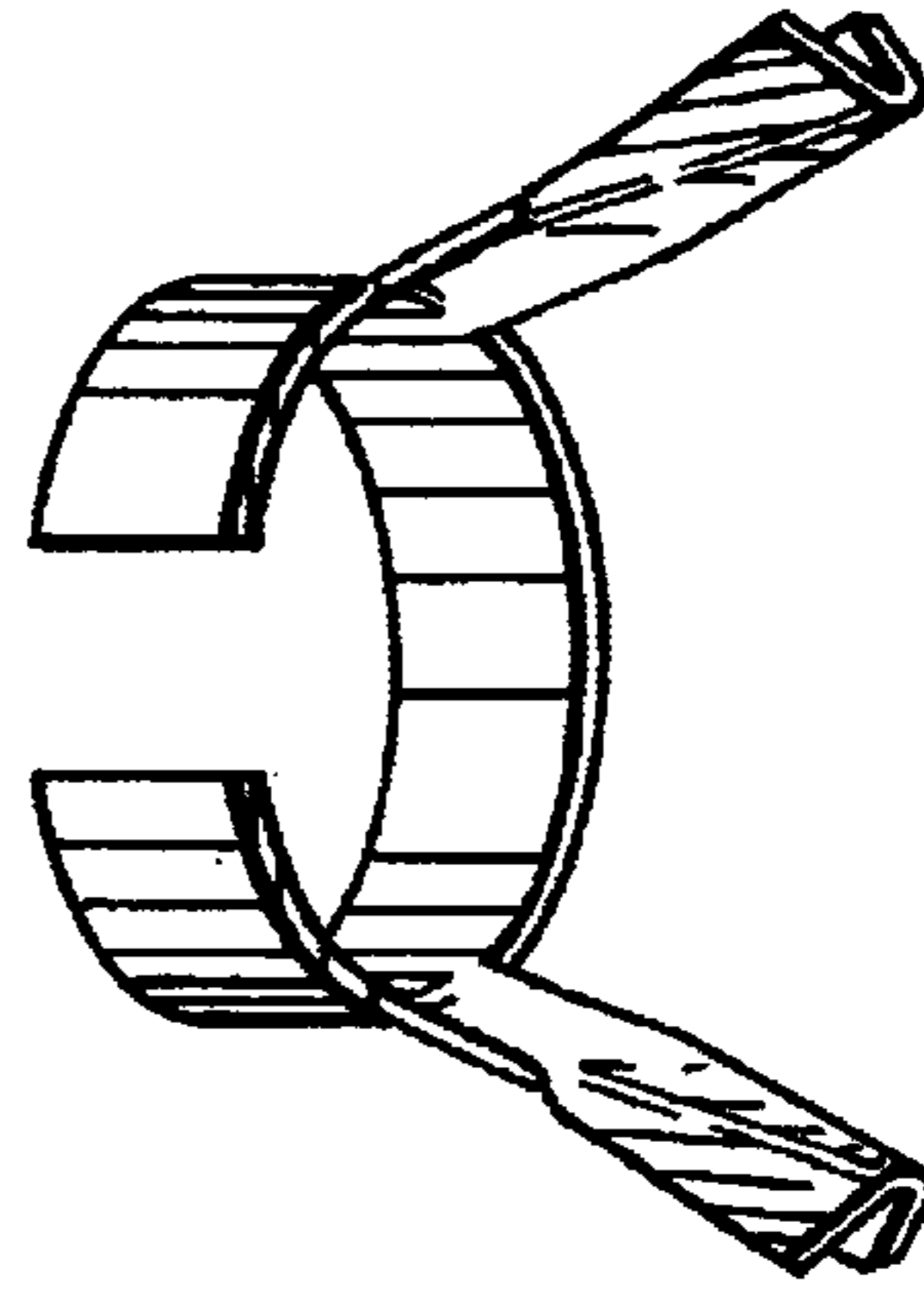

FIG. 2

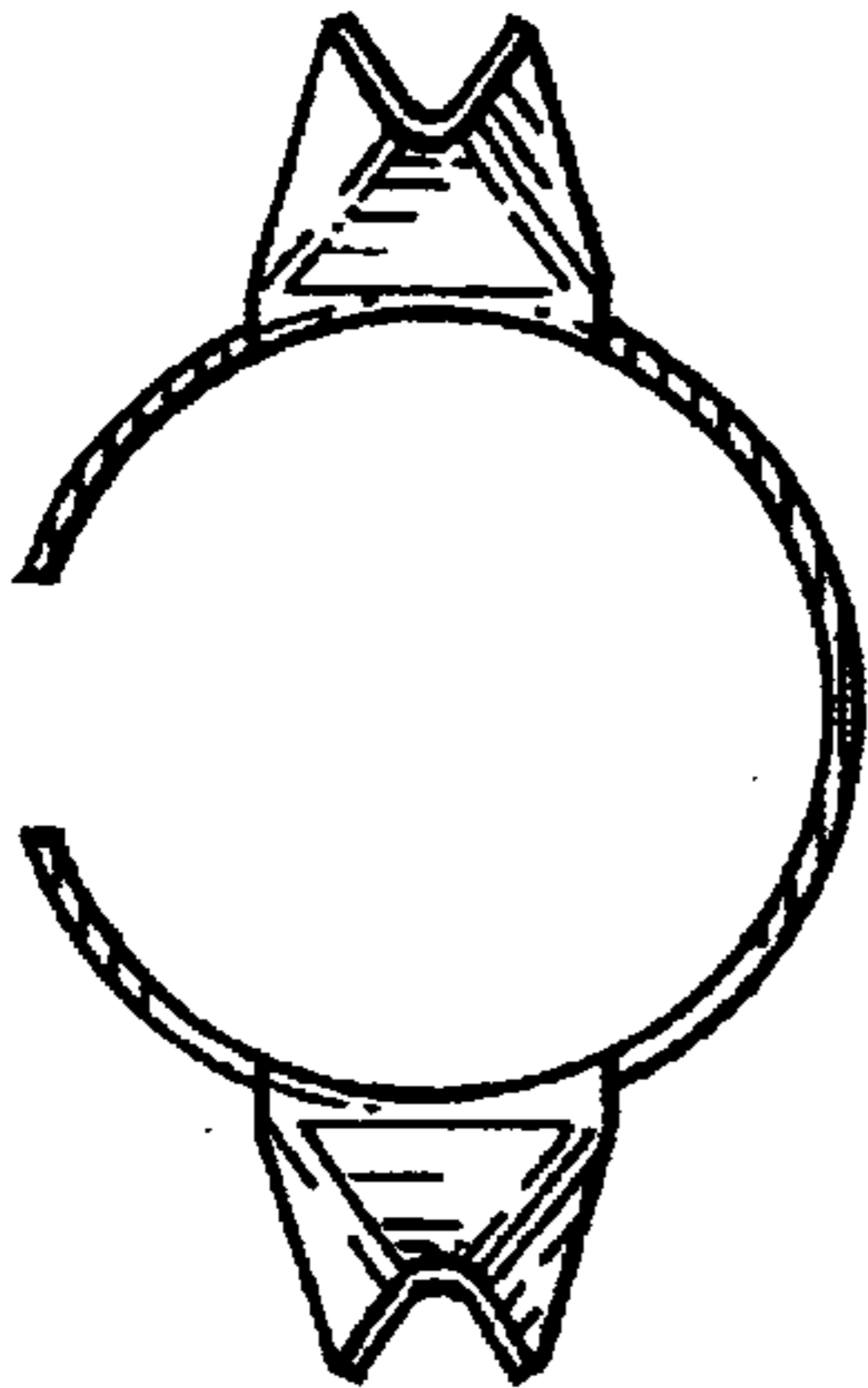

FIG. 3

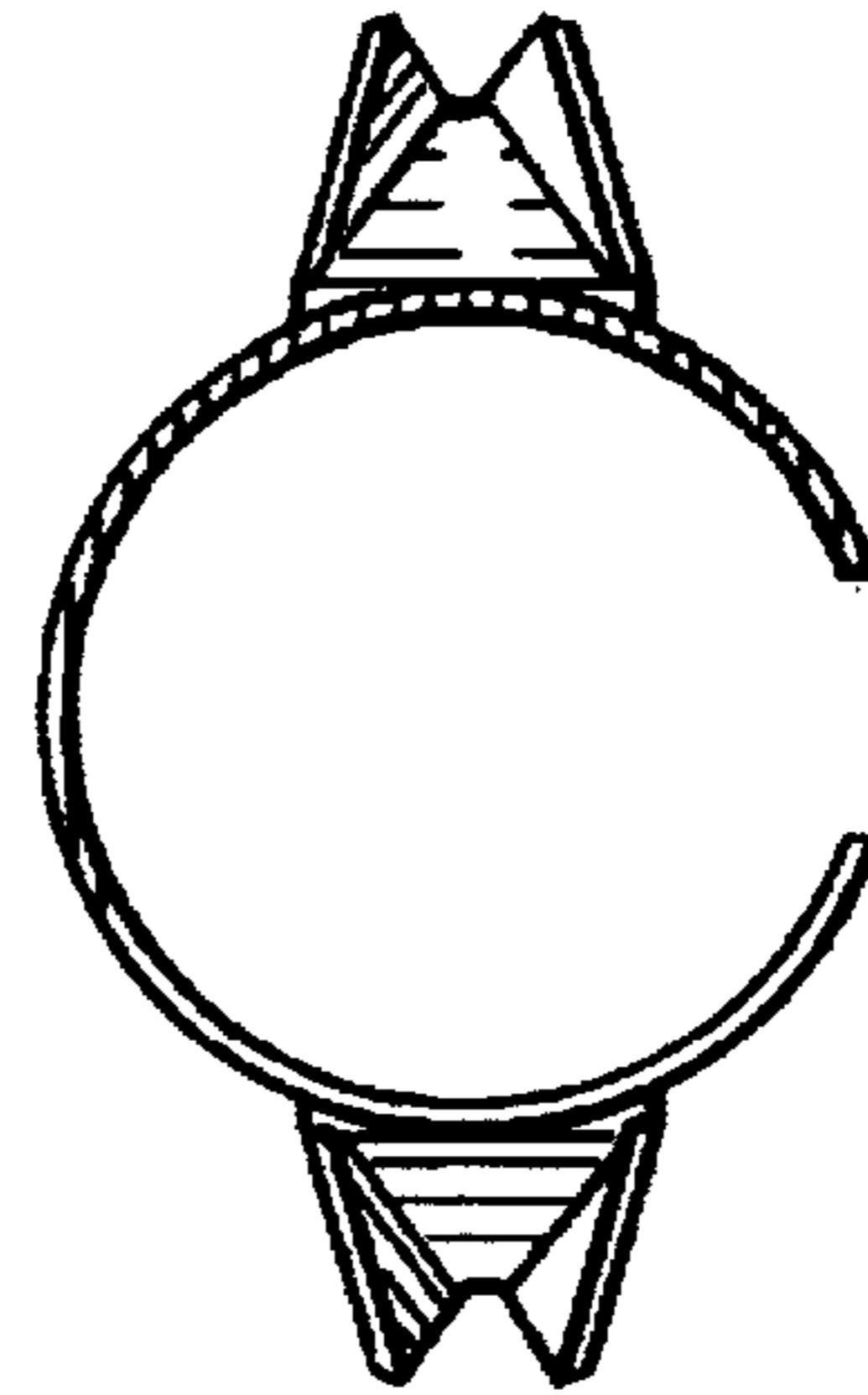

FIG. 4

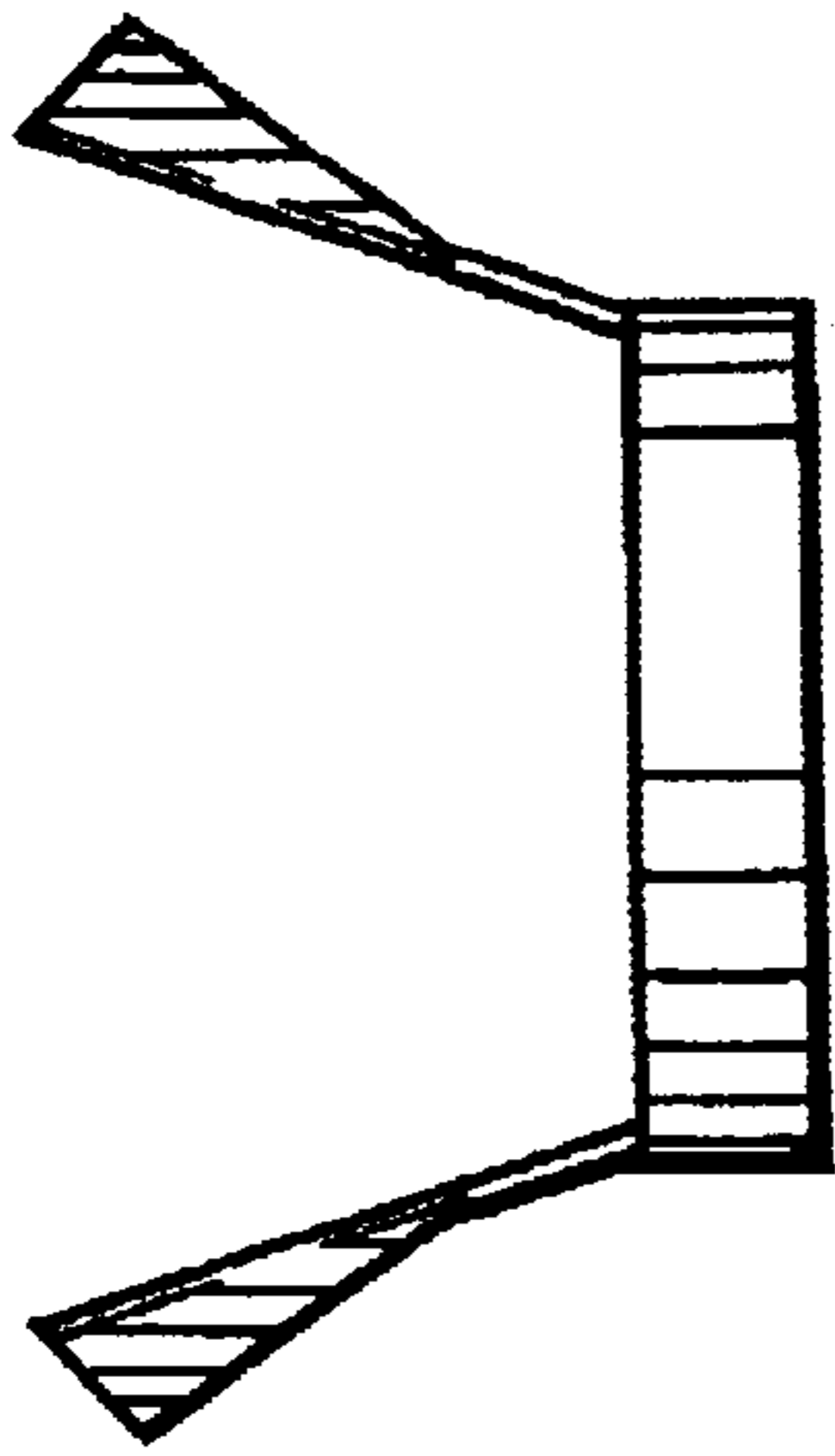

FIG. 5

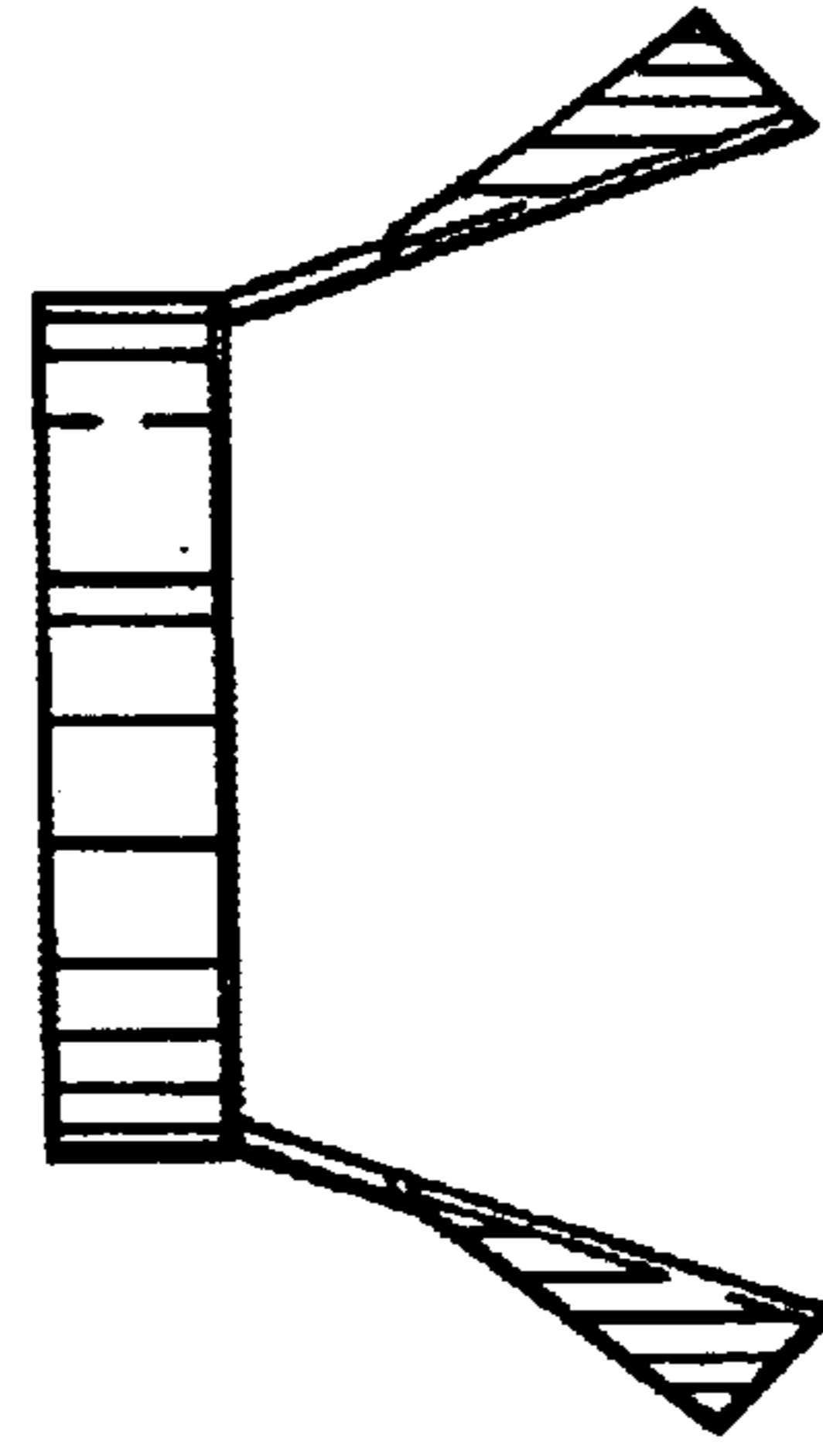

FIG. 6

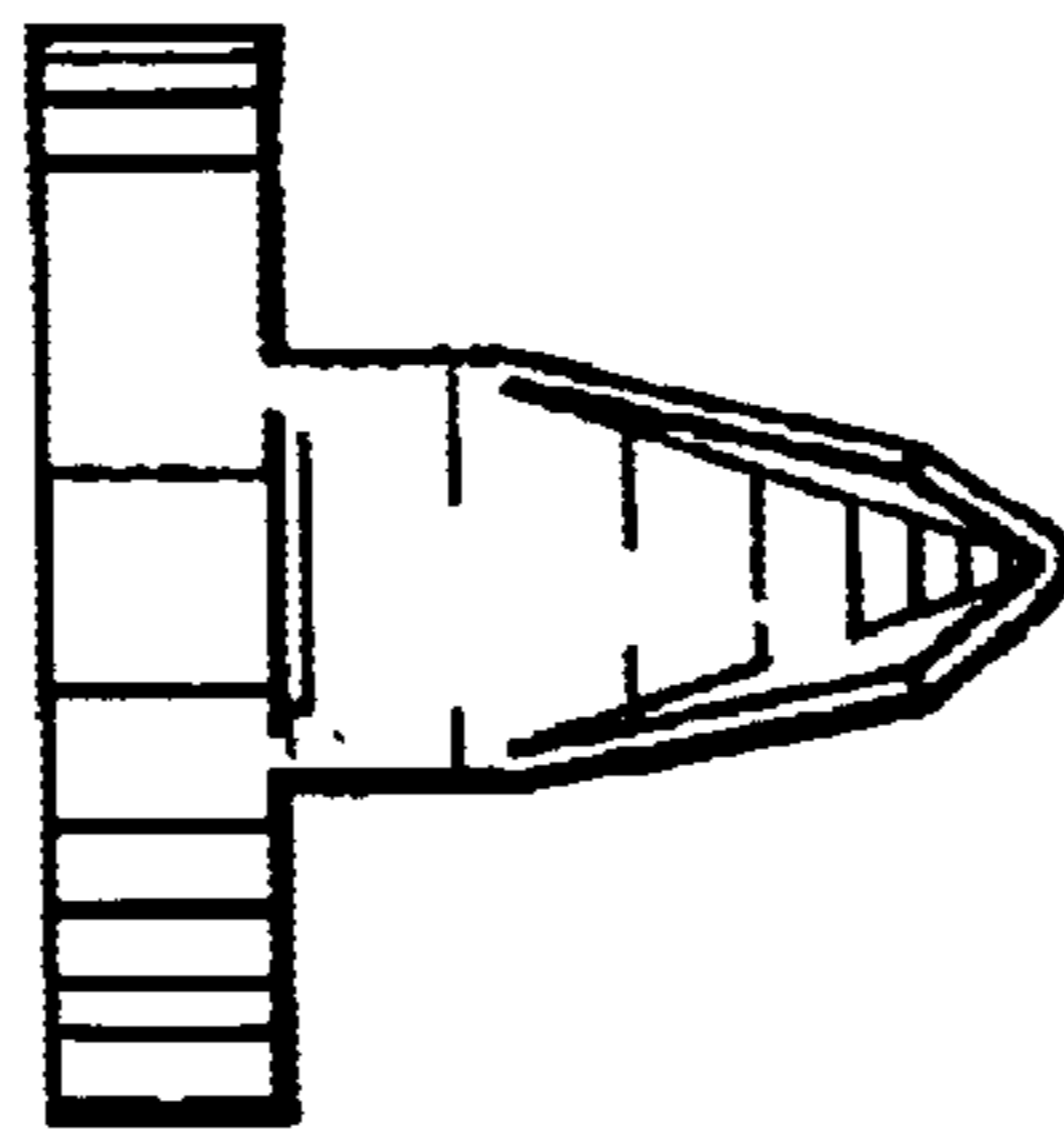

FIG. 7

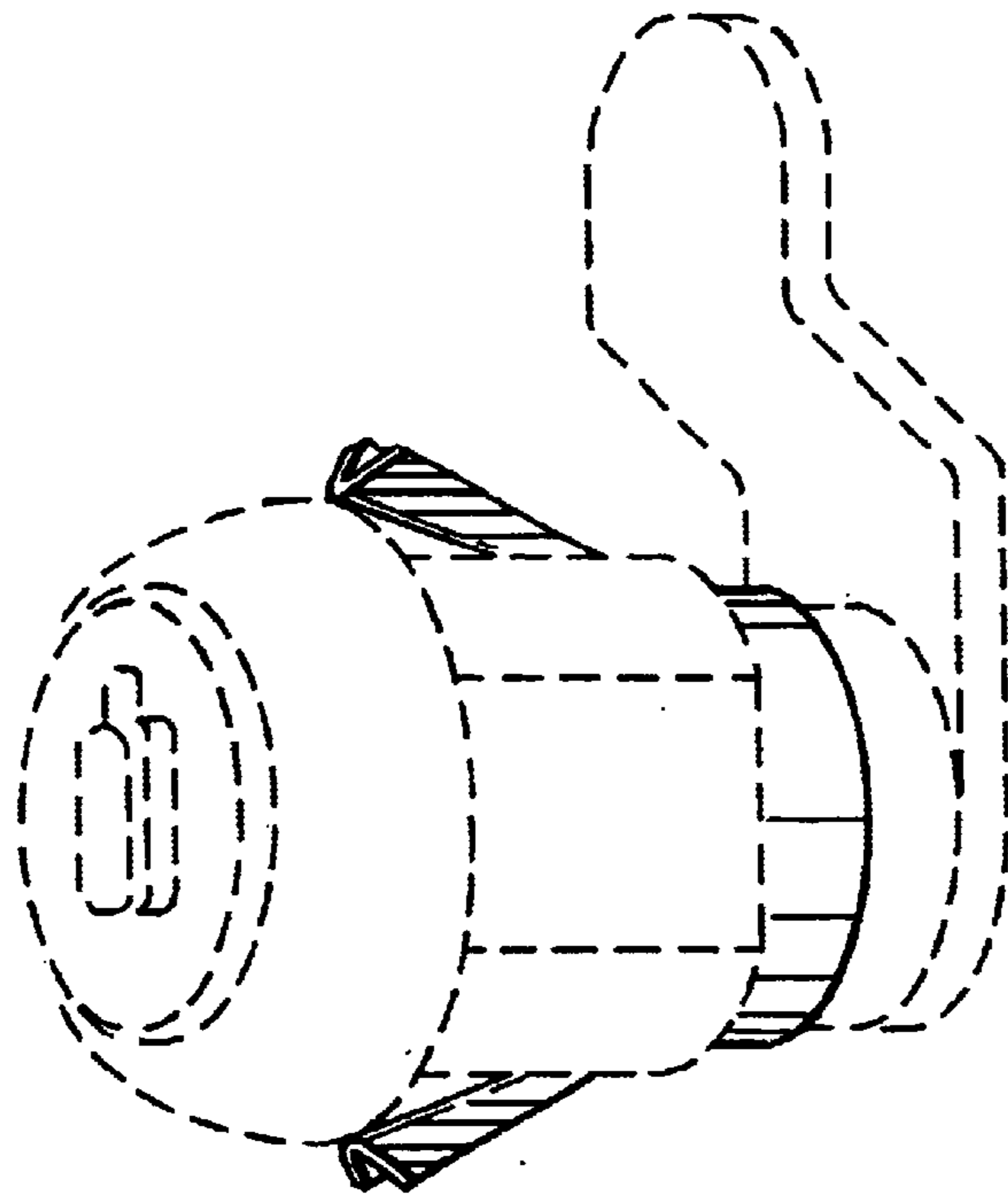

FIG. 8

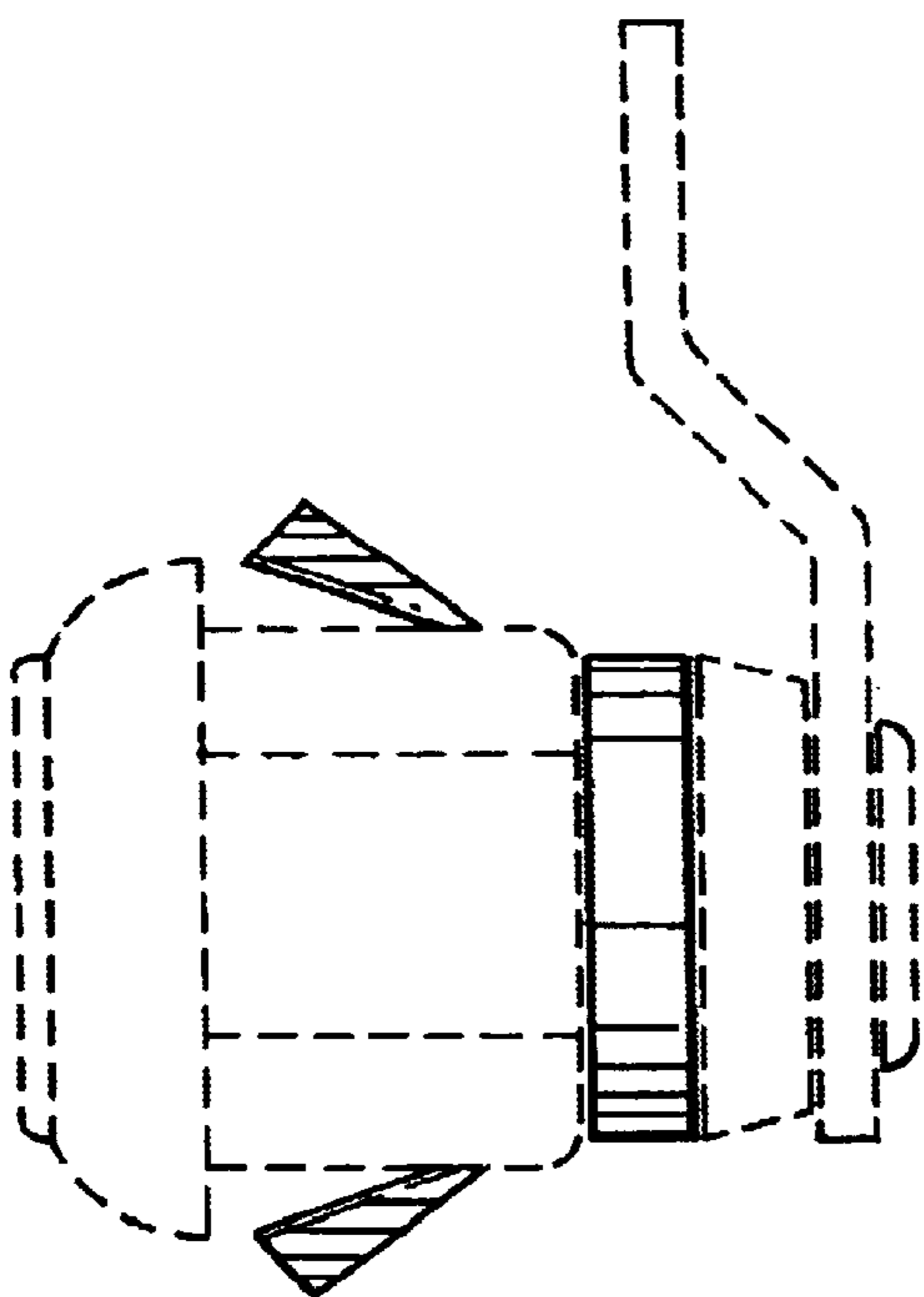

FIG. 9

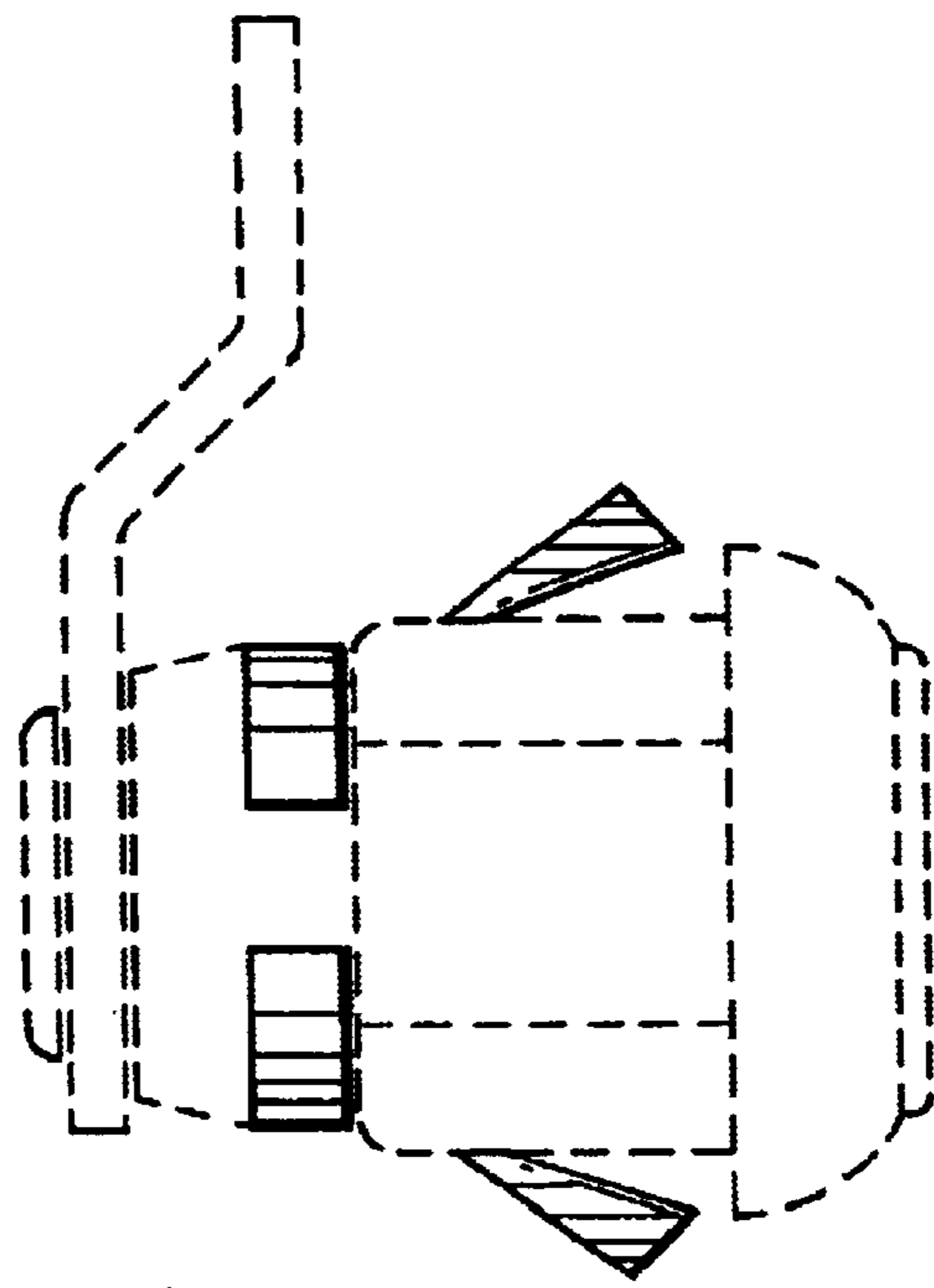

FIG. 10