



US00D490934S

(12) **United States Design Patent**
Graf

(10) **Patent No.:** **US D490,934 S**

(45) **Date of Patent:** **** Jun. 1, 2004**

(54) **COMBINED HAIR CUTTING MACHINE AND STAND**

(75) **Inventor:** **Norman Graf, Bad Dür rheim (DE)**

(73) **Assignee:** **Wahl GmbH, Unterkirnach (DE)**

(**) **Term:** **14 Years**

(21) **Appl. No.:** **29/164,144**

(22) **Filed:** **Jul. 18, 2002**

(30) **Foreign Application Priority Data**

Jan. 24, 2002 (WO) DM/059 501

(51) **LOC (7) Cl. 28-03**

(52) **U.S. Cl. D28/53**

(58) **Field of Search D28/44, 44.1, D28/49-54; 30/32, 42, 43, 199, 211, 203-207, 216, 223, 43.91, 43.92, 48-50, 34.1, 34.2, 34.05, 41.9, 43.1, 43.2, 43.3**

(56) **References Cited**

U.S. PATENT DOCUMENTS

D339,655 S	*	9/1993	Sulik	D28/53
D405,924 S	*	2/1999	Lebherz	D28/53
6,112,414 A	*	9/2000	Andis et al.	30/34.05
D435,694 S	*	12/2000	Lebherz	D28/53
D455,864 S	*	4/2002	Rizzuto et al.	D28/53
6,405,439 B1	*	6/2002	Malobabic et al.	30/43.92
D464,466 S	*	10/2002	Rizzuto et al.	D28/53

* cited by examiner

Primary Examiner—Jennifer Rivard

(74) *Attorney, Agent, or Firm*—Choate, Hall & Stewart

(57) **CLAIM**

The ornamental design for combined hair cutting machine and stand, as shown and described.

DESCRIPTION

FIG. 1 is a perspective view of my design for a combined hair cutting machine and stand;
 FIG. 2 is a top plan view of my design for a combined hair cutting machine;
 FIG. 3 is a side elevational view of my design for combined hair cutting machine;
 FIG. 4 is a side elevational view of the opposite side of my design for combined hair cutting machine;
 FIG. 5 is a bottom plan view of my design for combined hair cutting machine;
 FIG. 6 is a top plan view of my design for combined hair cutting machine;
 FIG. 7 is a bottom plan view of my design for combined hair cutting machine;
 FIG. 8 is a perspective view of my design for combined hair cutting machine;
 FIG. 9 is a perspective view of my design for a stand for a combined hair cutting machine;
 FIG. 10 is an elevational view of my design for a stand for a combined hair cutting machine;
 FIG. 11 is a an end view of the opposite end of the stand for combined hair cutting machine;
 FIG. 12 is a side elevational view of the stand for my combined hair cutting machine;
 FIG. 13 is an elevational view of the opposite side of my design for stand for combined hair cutting machine; and,
 FIG. 14 is a top plan view of my design for stand for combined hair cutting machine.

The hair cutting machine and the stand are shown separately for convenience of illustration.

1 Claim, 9 Drawing Sheets

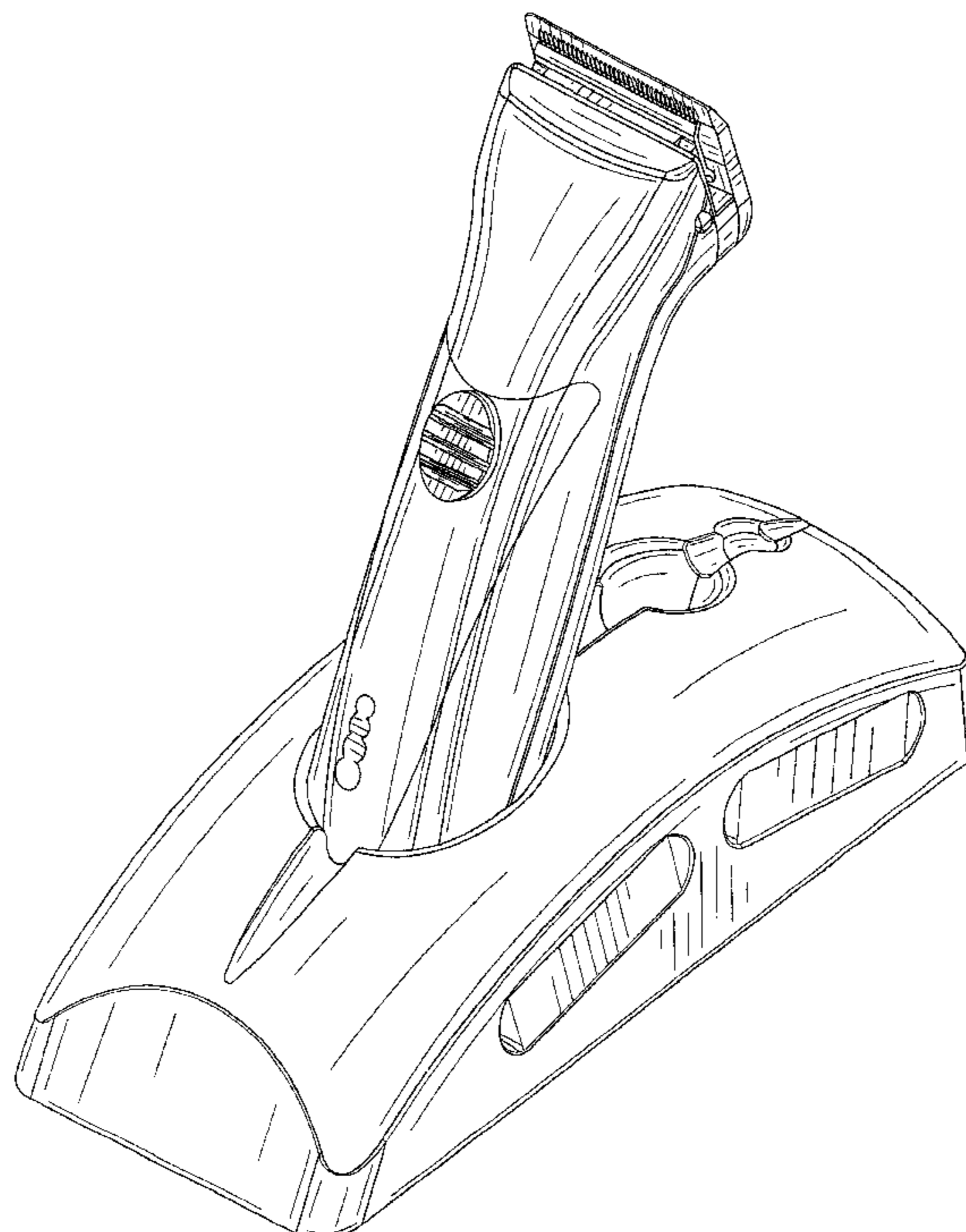

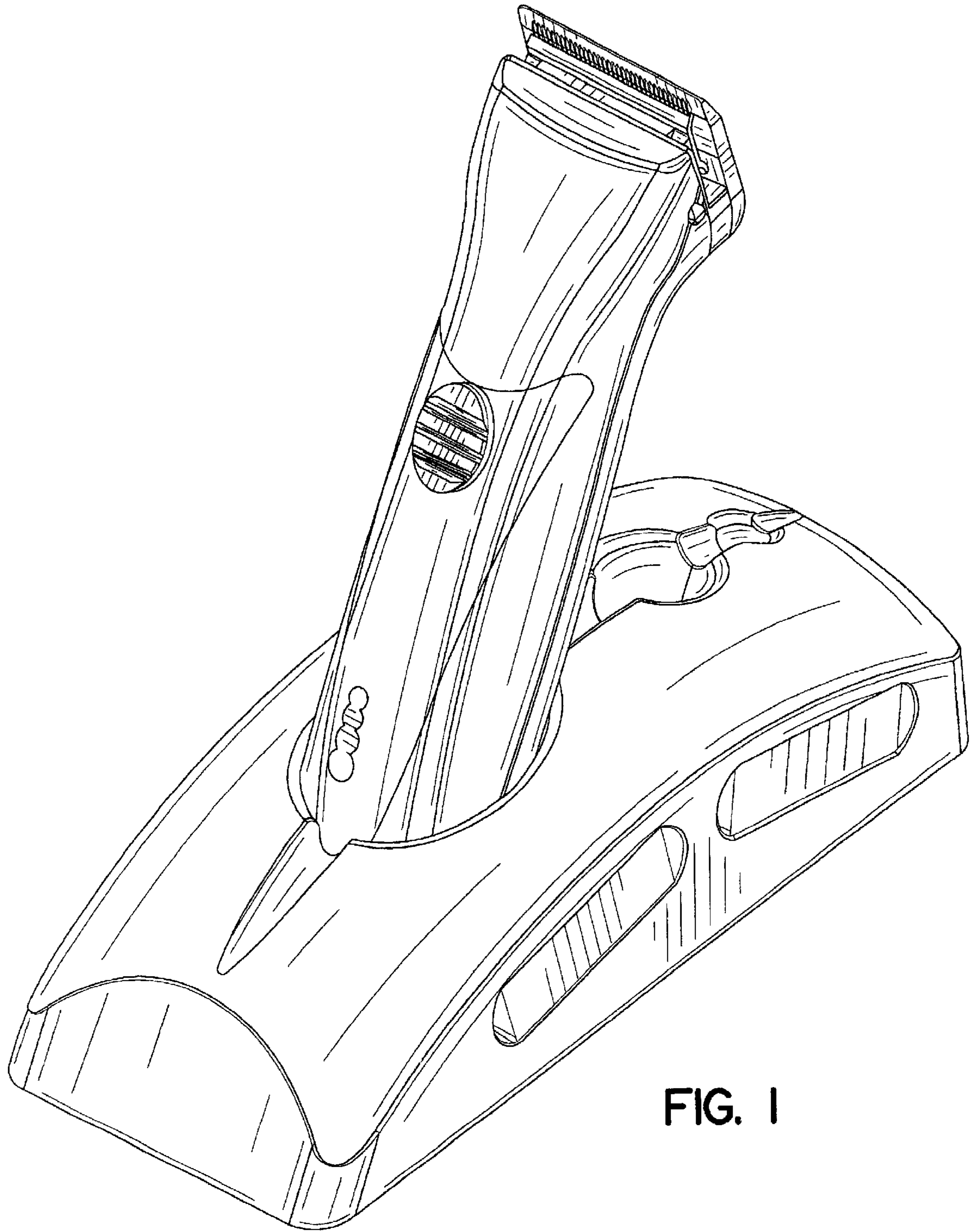

FIG. 1

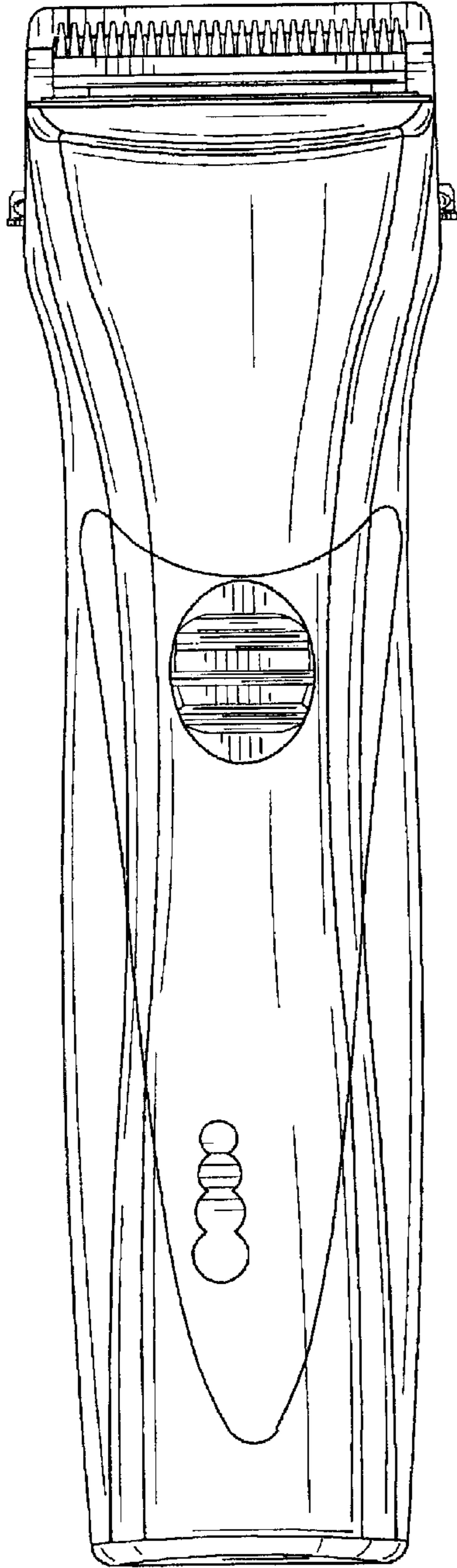

FIG. 2

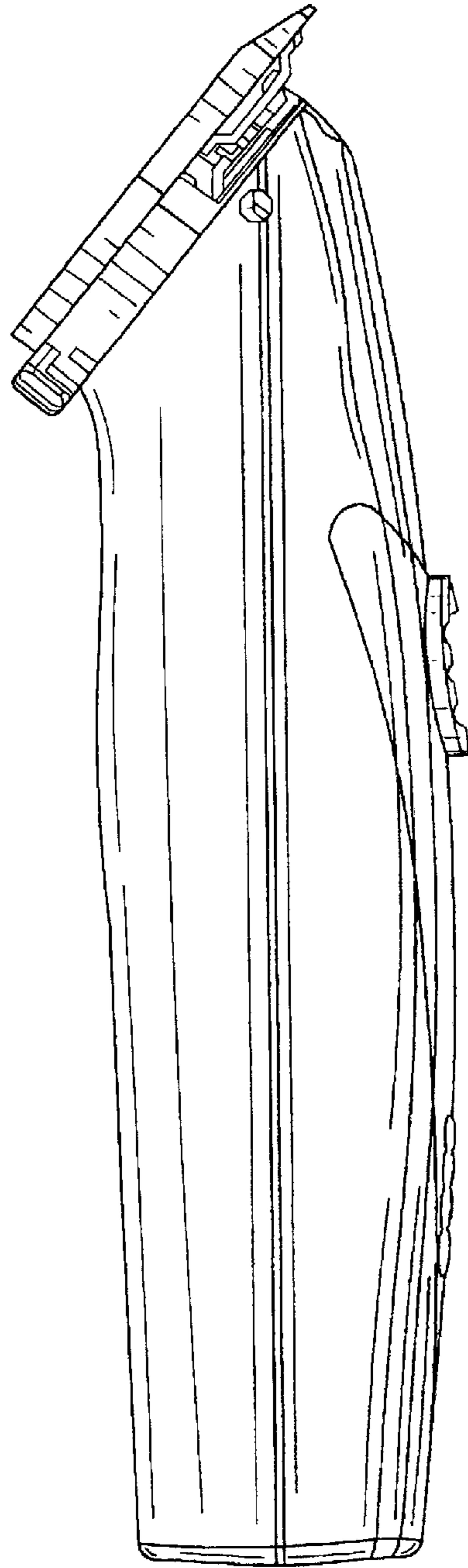

FIG. 3

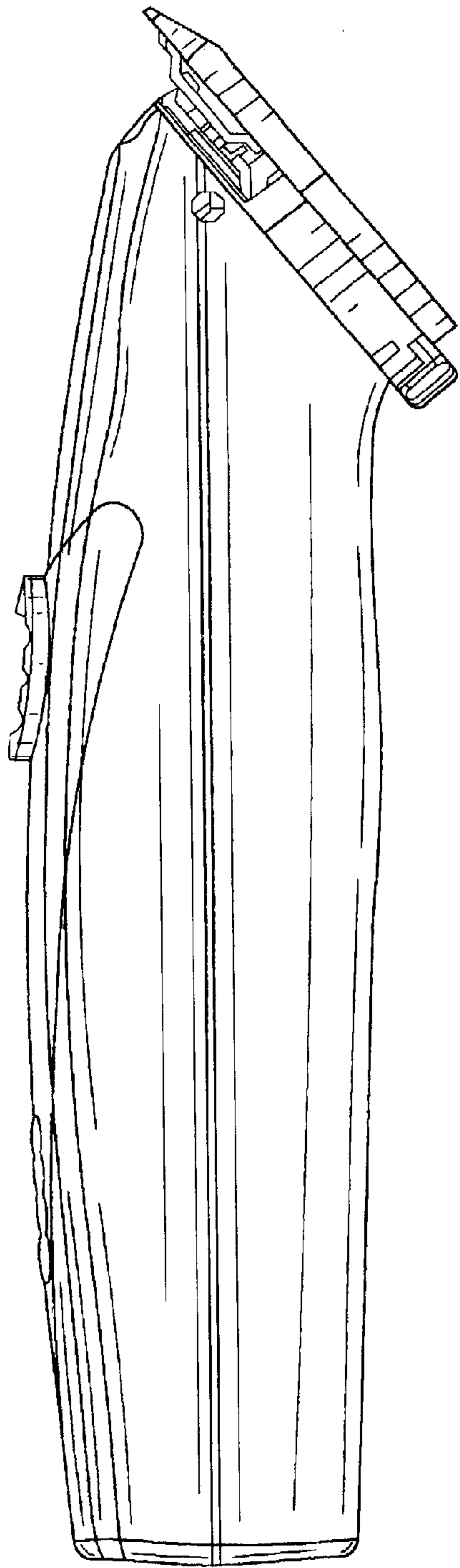

FIG. 4

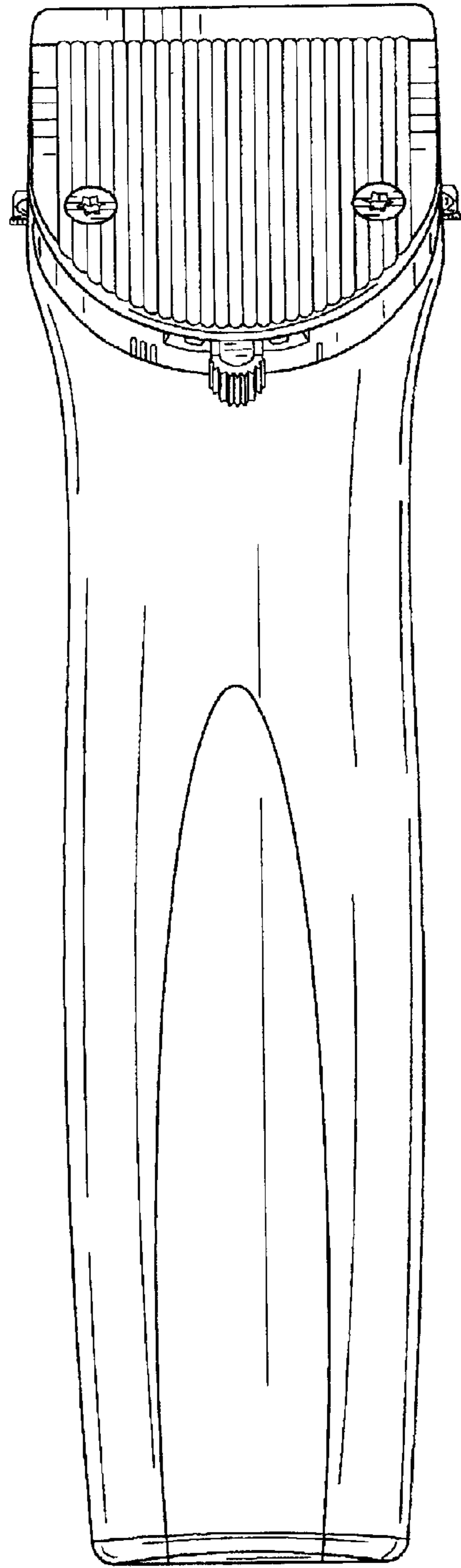

FIG. 5

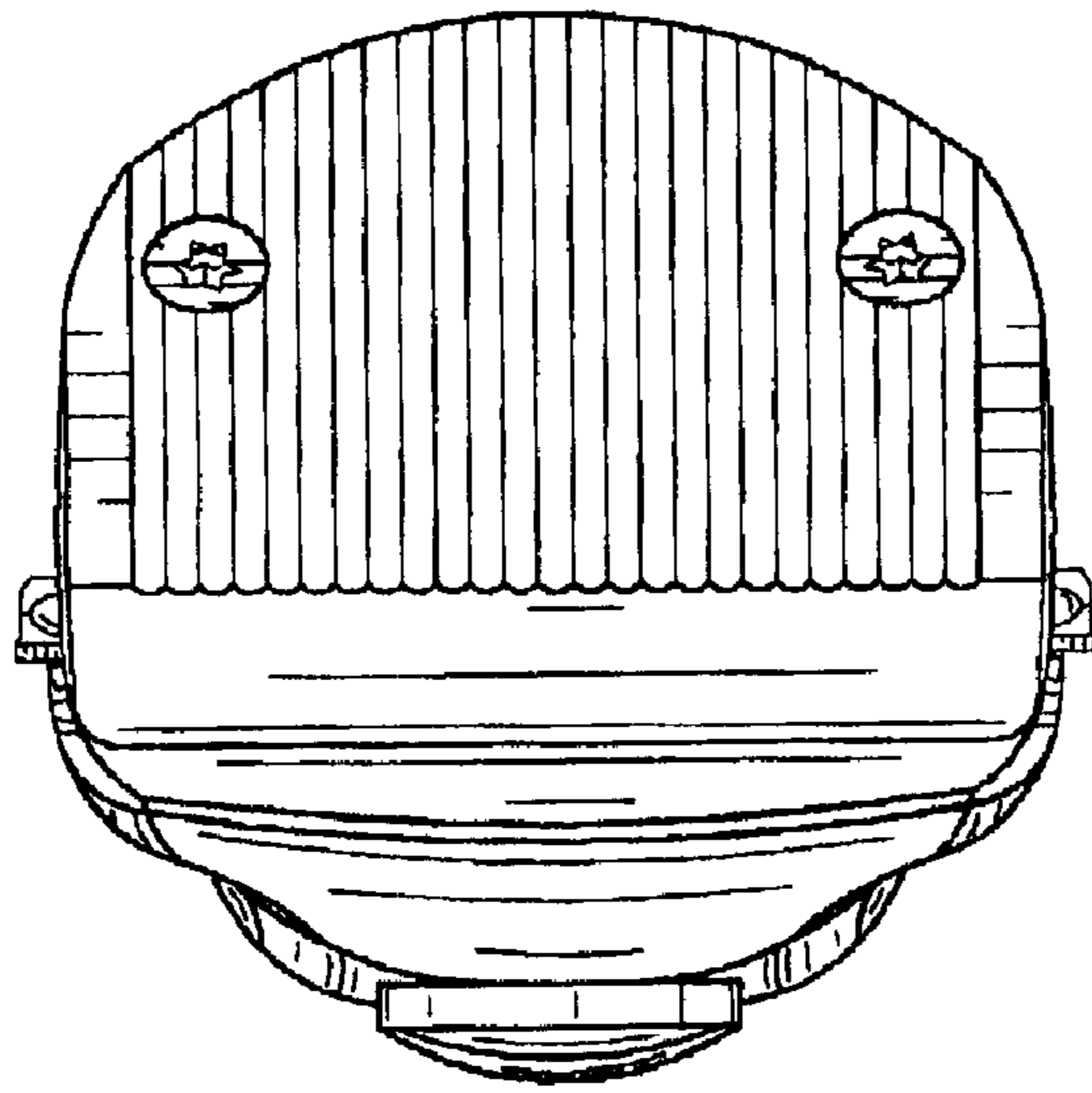

FIG. 6

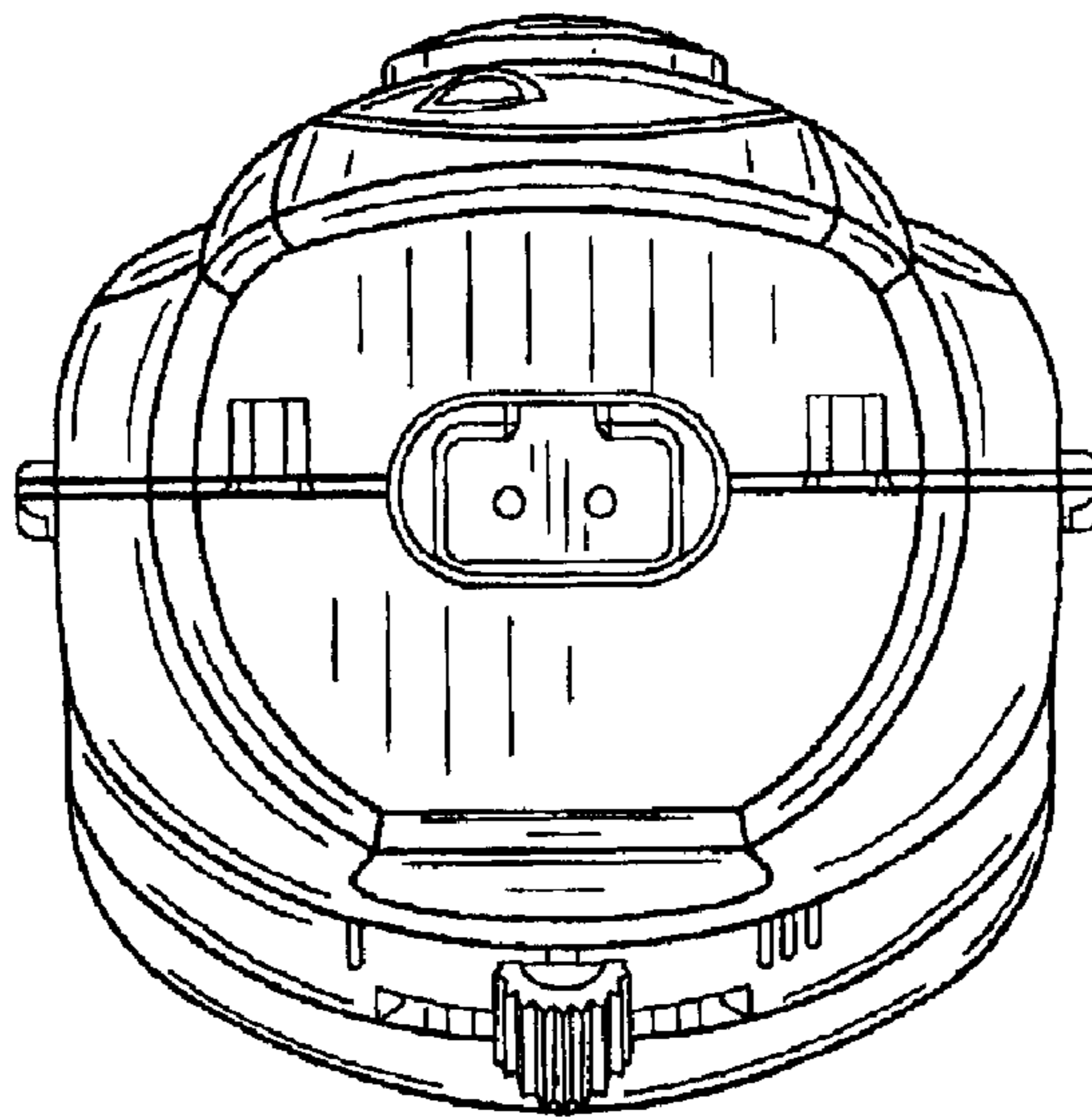

FIG. 7

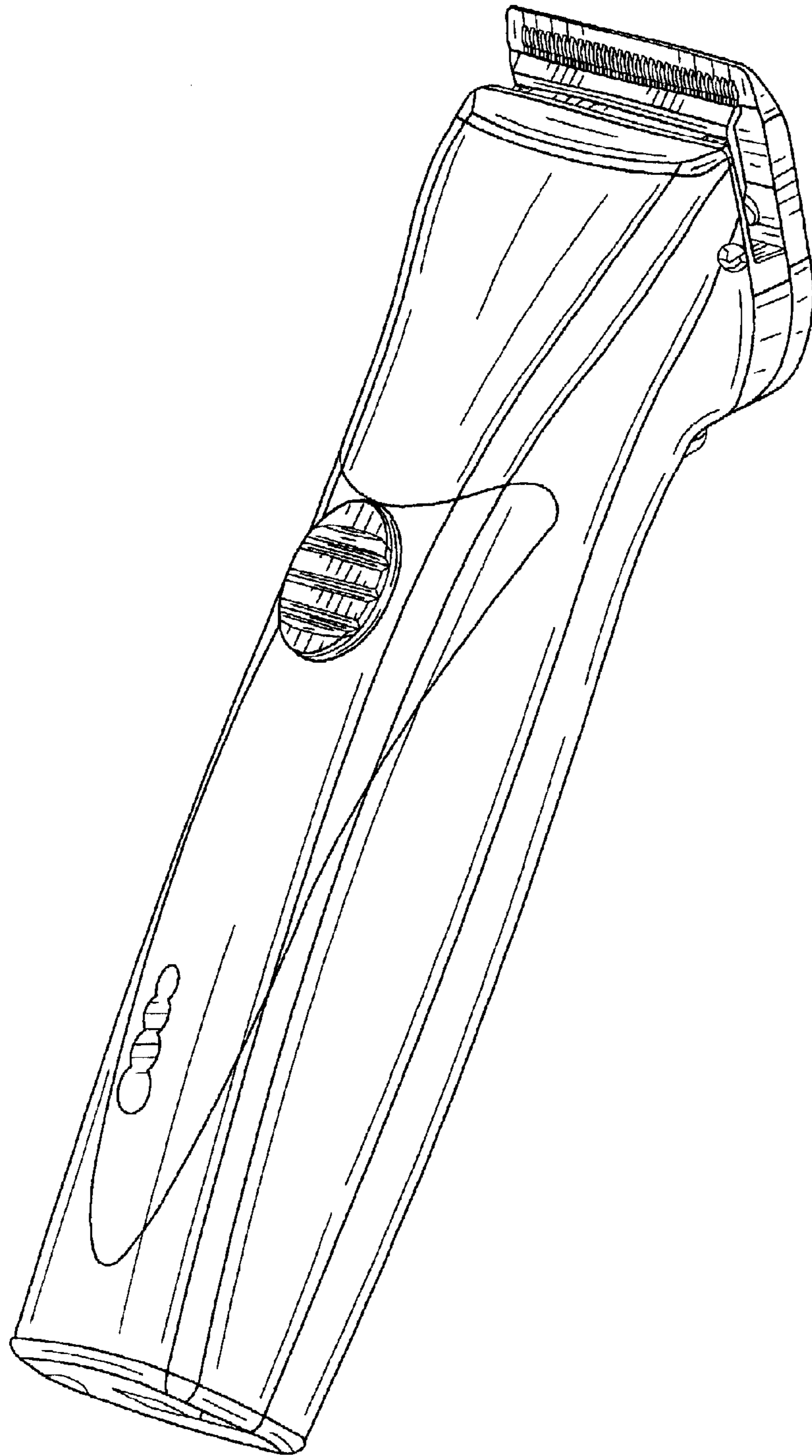

FIG. 8

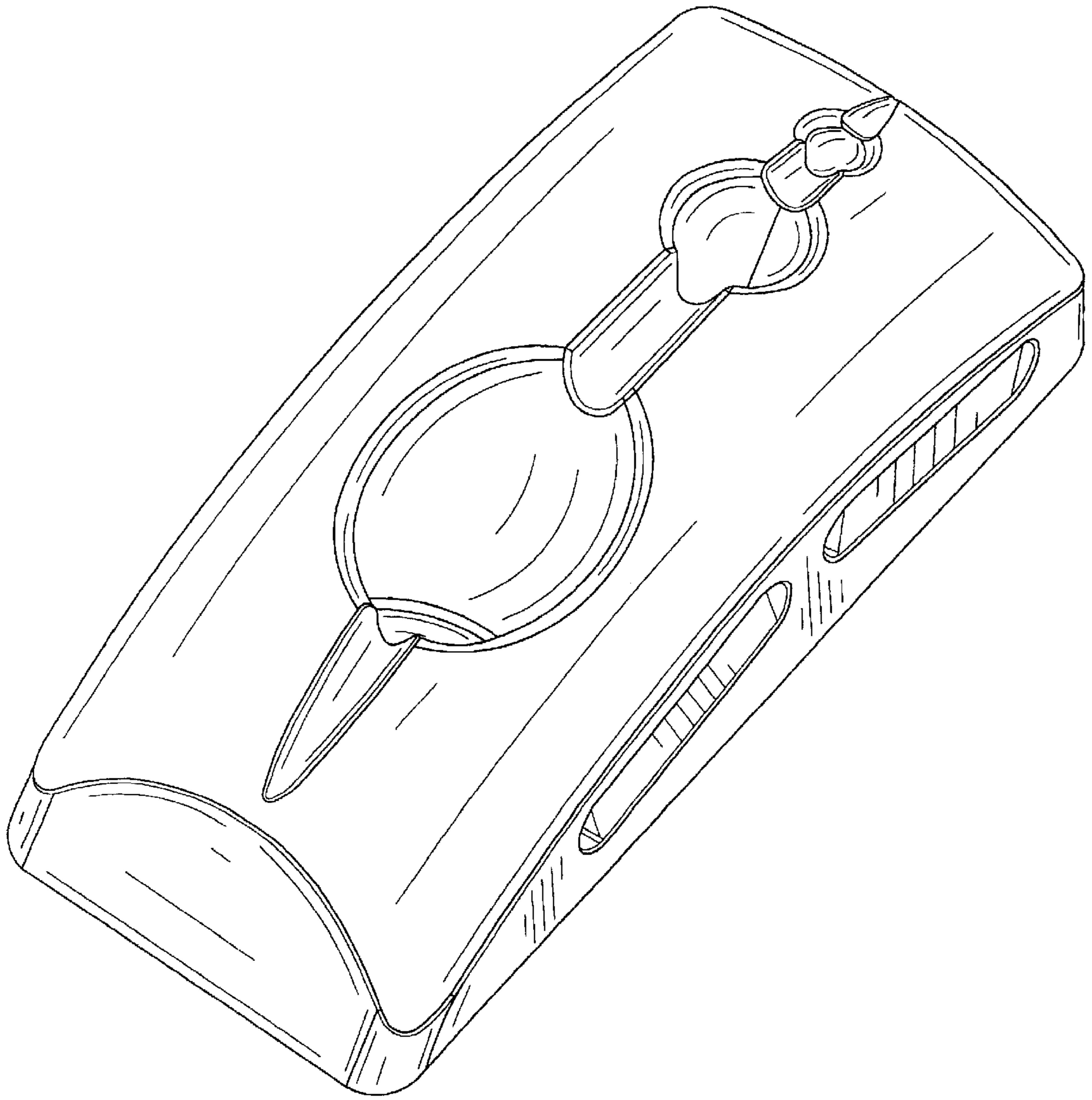

FIG. 9

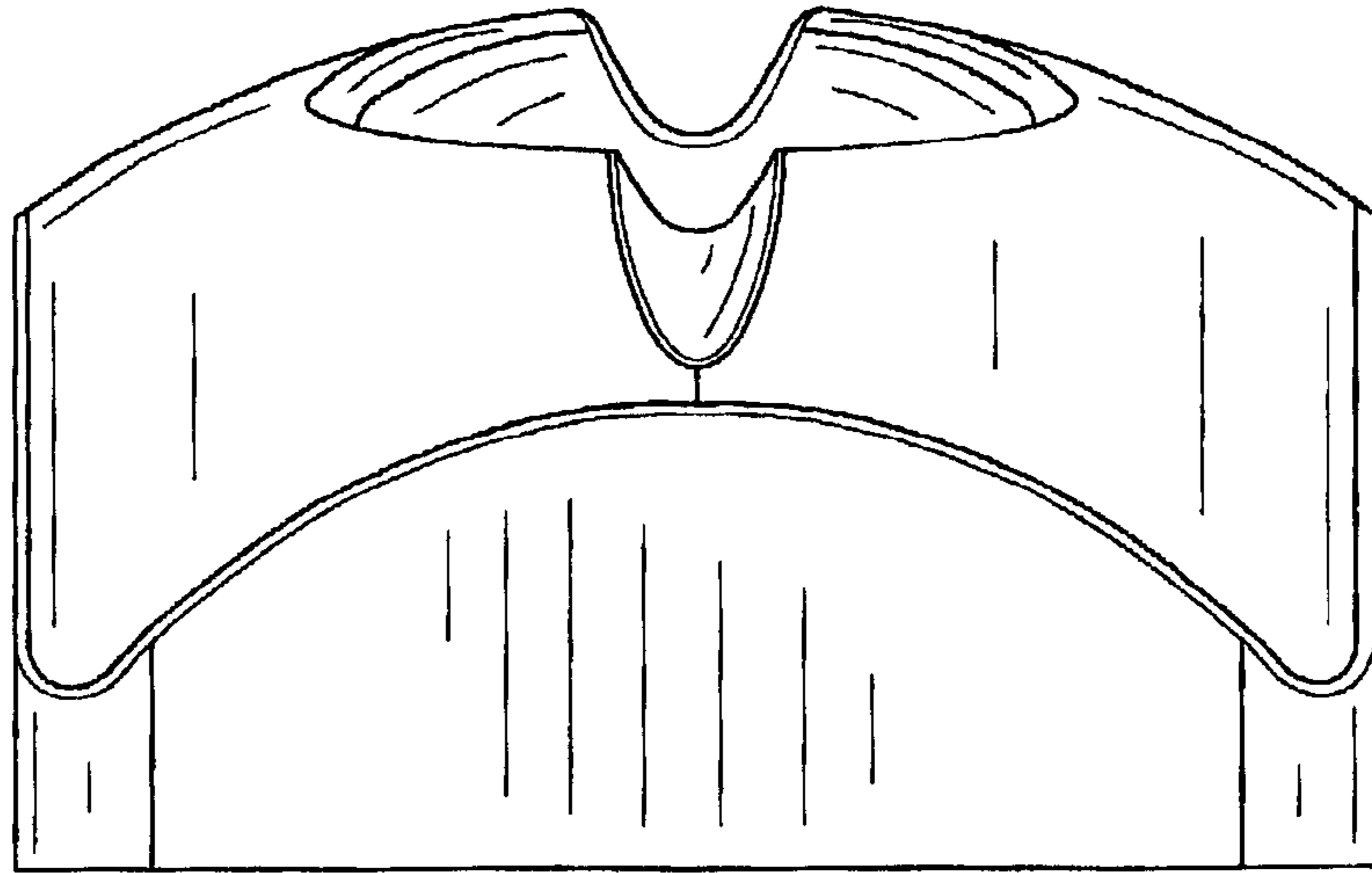

FIG. 10

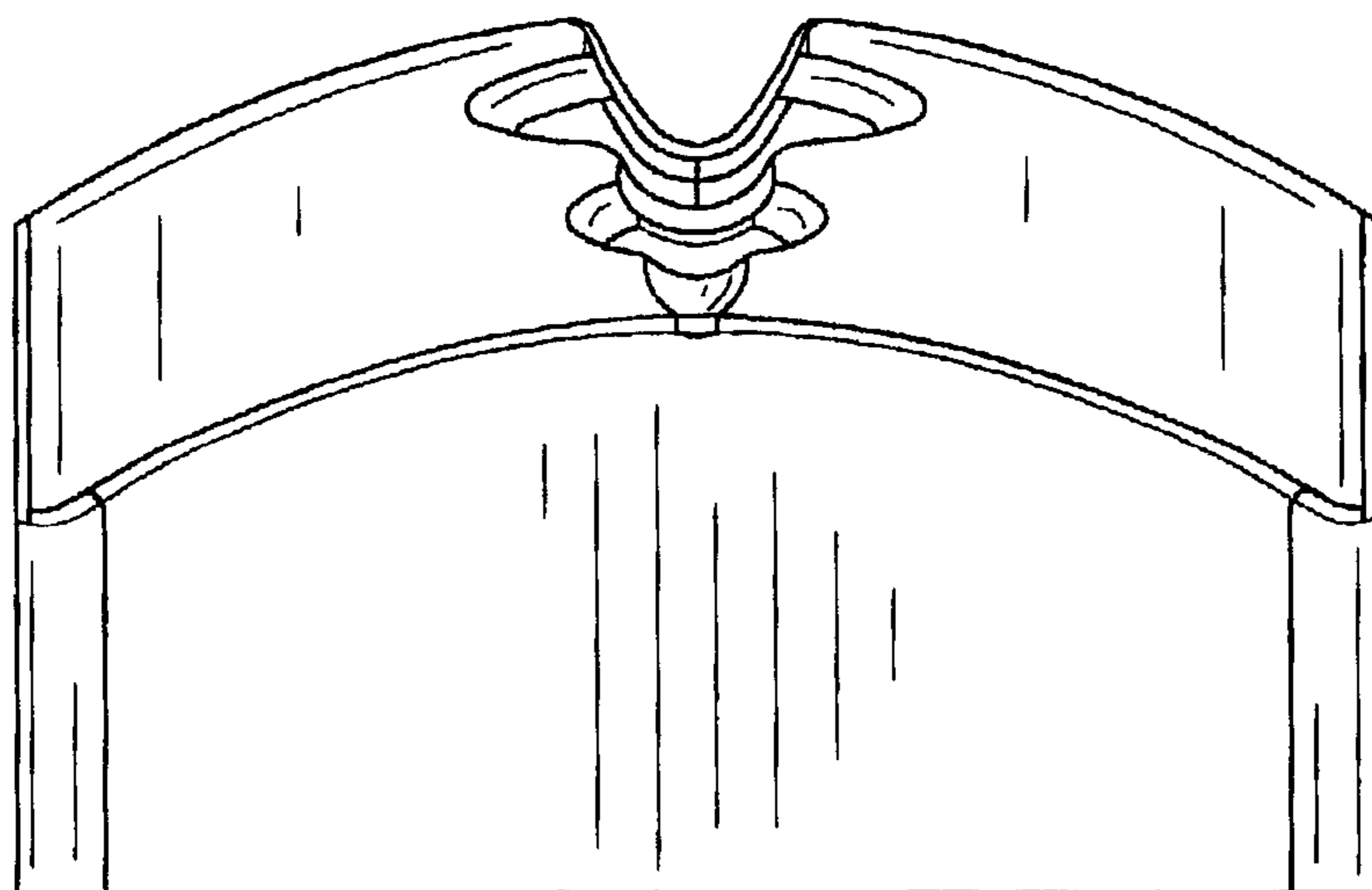

FIG. 11

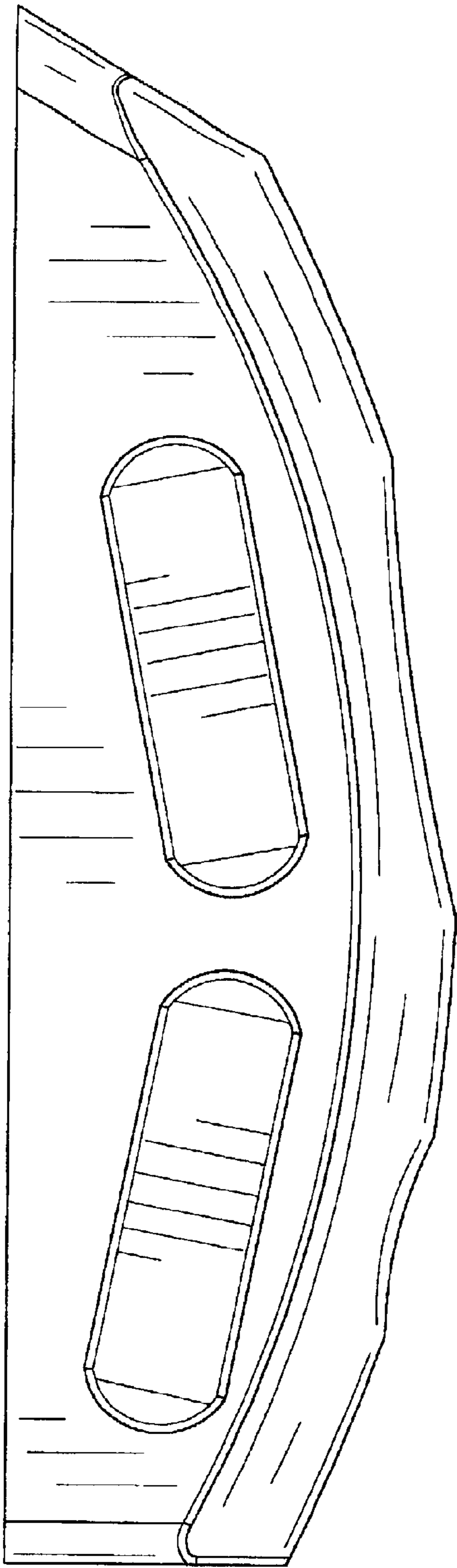

FIG. 12

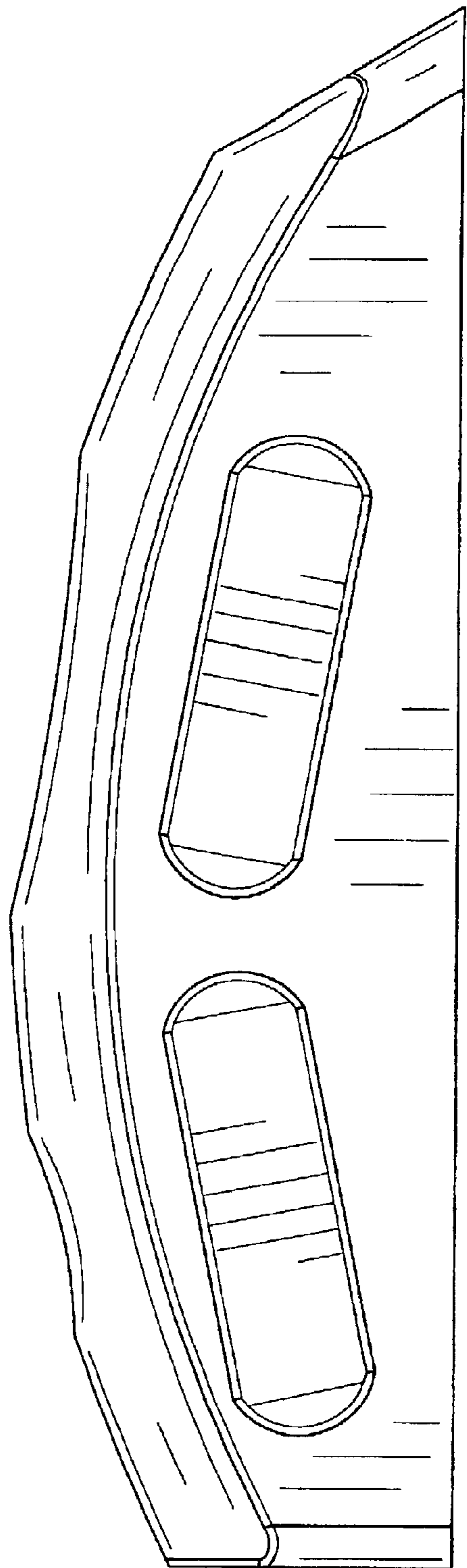

FIG. 13

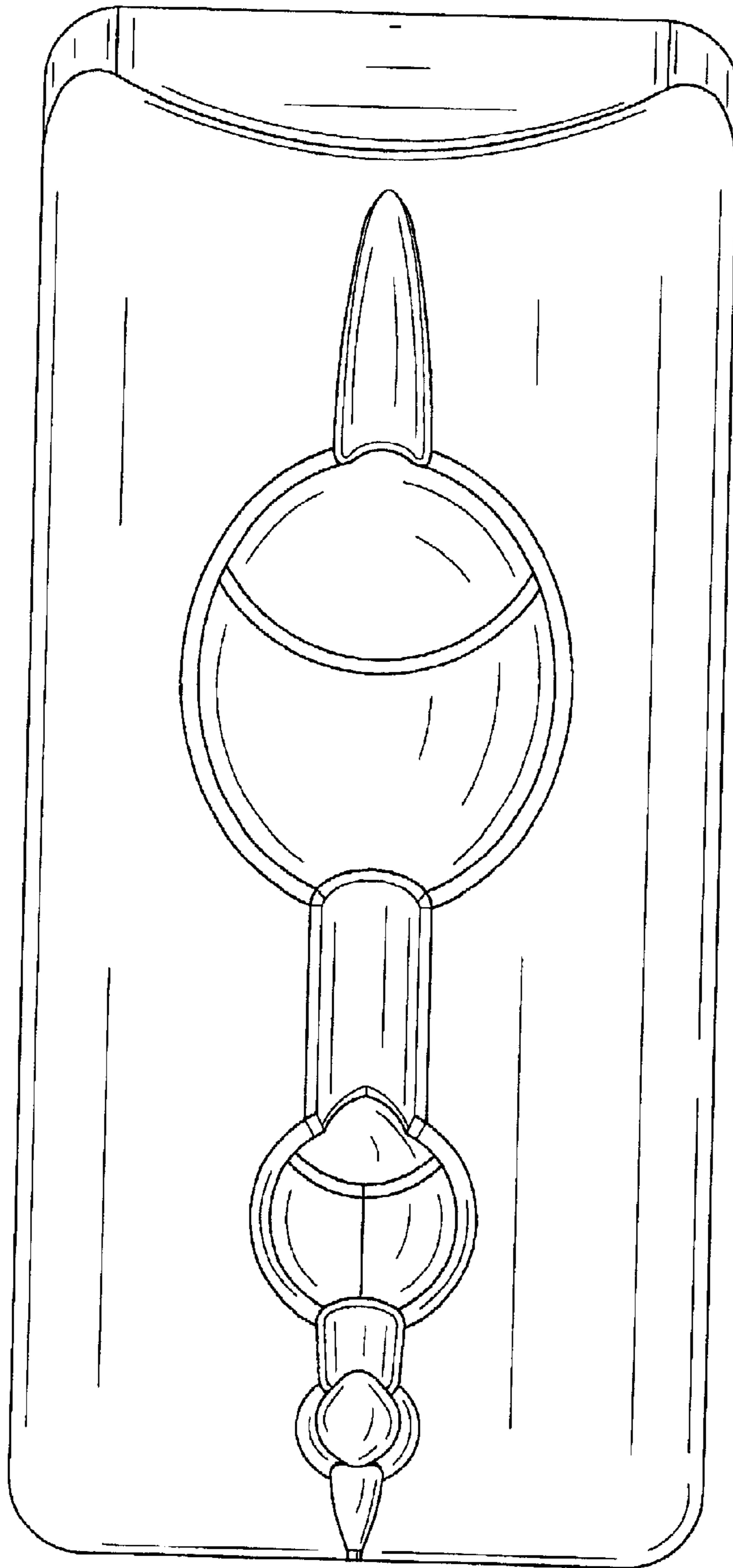

FIG. 14