



US00D490928S

(12) **United States Design Patent**
Curtin

(10) **Patent No.:** **US D490,928 S**

(45) **Date of Patent:** **** Jun. 1, 2004**

(54) **LIGHTING FIXTURE**

(76) Inventor: **Brett Curtin**, 4301 E. Evans Dr.,
Phoenix, AZ (US) 85032

(**) Term: **14 Years**

(21) Appl. No.: **29/188,649**

(22) Filed: **Aug. 21, 2003**

(51) **LOC (7) Cl.** **26-03**

(52) **U.S. Cl.** **D26/92**

(58) **Field of Search** D26/24, 27, 59,
D26/72, 79, 128, 131; 362/147, 404-408,
432

(56) **References Cited**

U.S. PATENT DOCUMENTS

D316,912 S	*	5/1991	Choi	D26/87
D333,531 S	*	2/1993	Rottner	D26/87
D439,362 S	*	3/2001	Berry	D26/87
D463,606 S	*	9/2002	Orozco	D26/87

OTHER PUBLICATIONS

Corbett Lighting 2000; item 5732 on p. 17.*
Corbett Lighting Catalog 2000; item 5741 on p. 18.*
Corbett Lighting Catalog 2000; item 5762 on p. 141.*

* cited by examiner

Primary Examiner—Clare E Heflin

(57) **CLAIM**

The ornamental design for a lighting fixture, as shown and described.

DESCRIPTION

FIG. 1 is a perspective view thereof;
FIG. 2 is a right side view, the left side view being a mirror image;
FIG. 3 is a front view thereof;
FIG. 4 is a top view thereof; and,
FIG. 5 is a bottom view thereof.

The broken lines shown on the drawings are for illustrative purposes only and form no part of the claimed design.

1 Claim, 5 Drawing Sheets

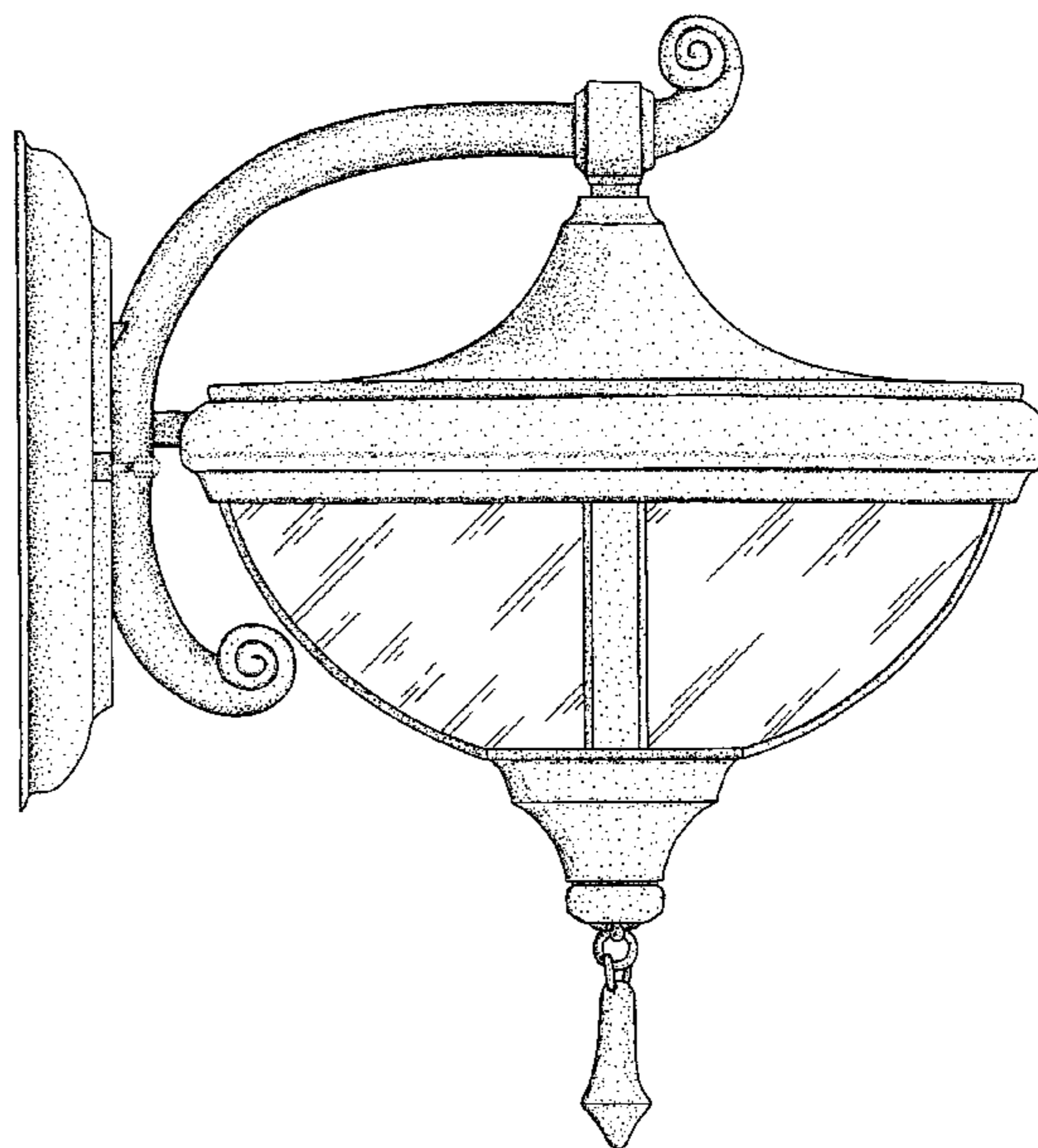
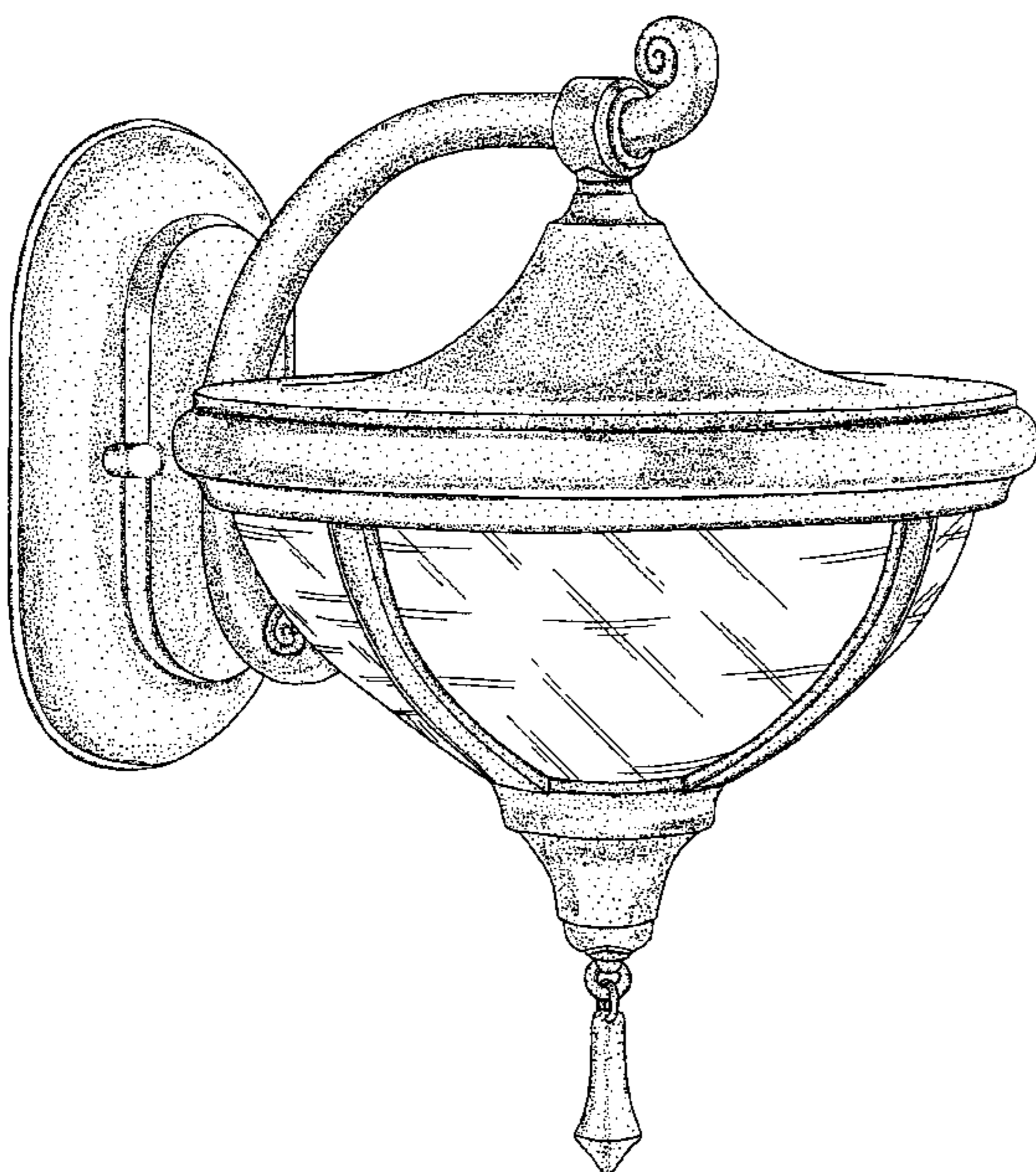

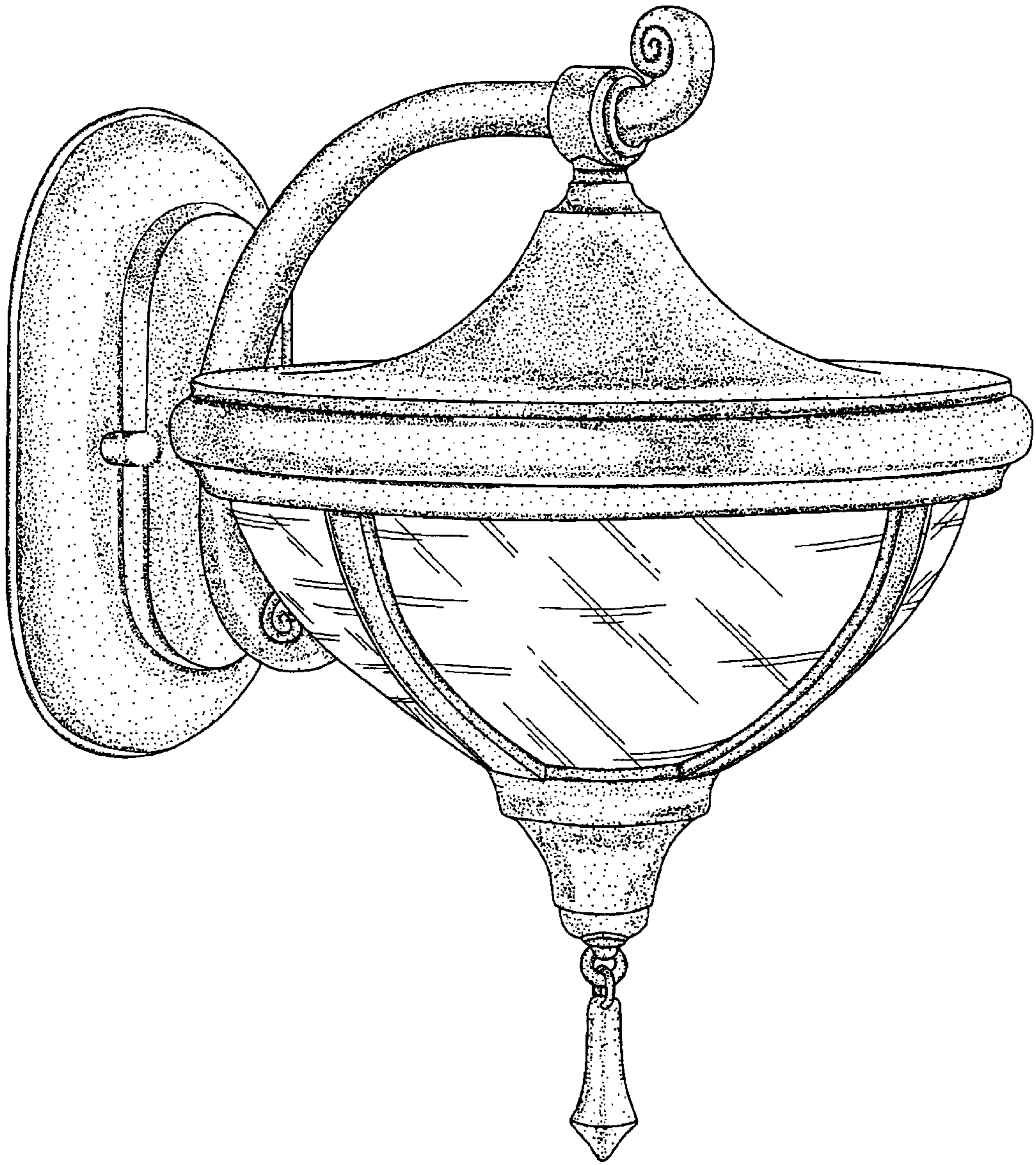

Fig. 1

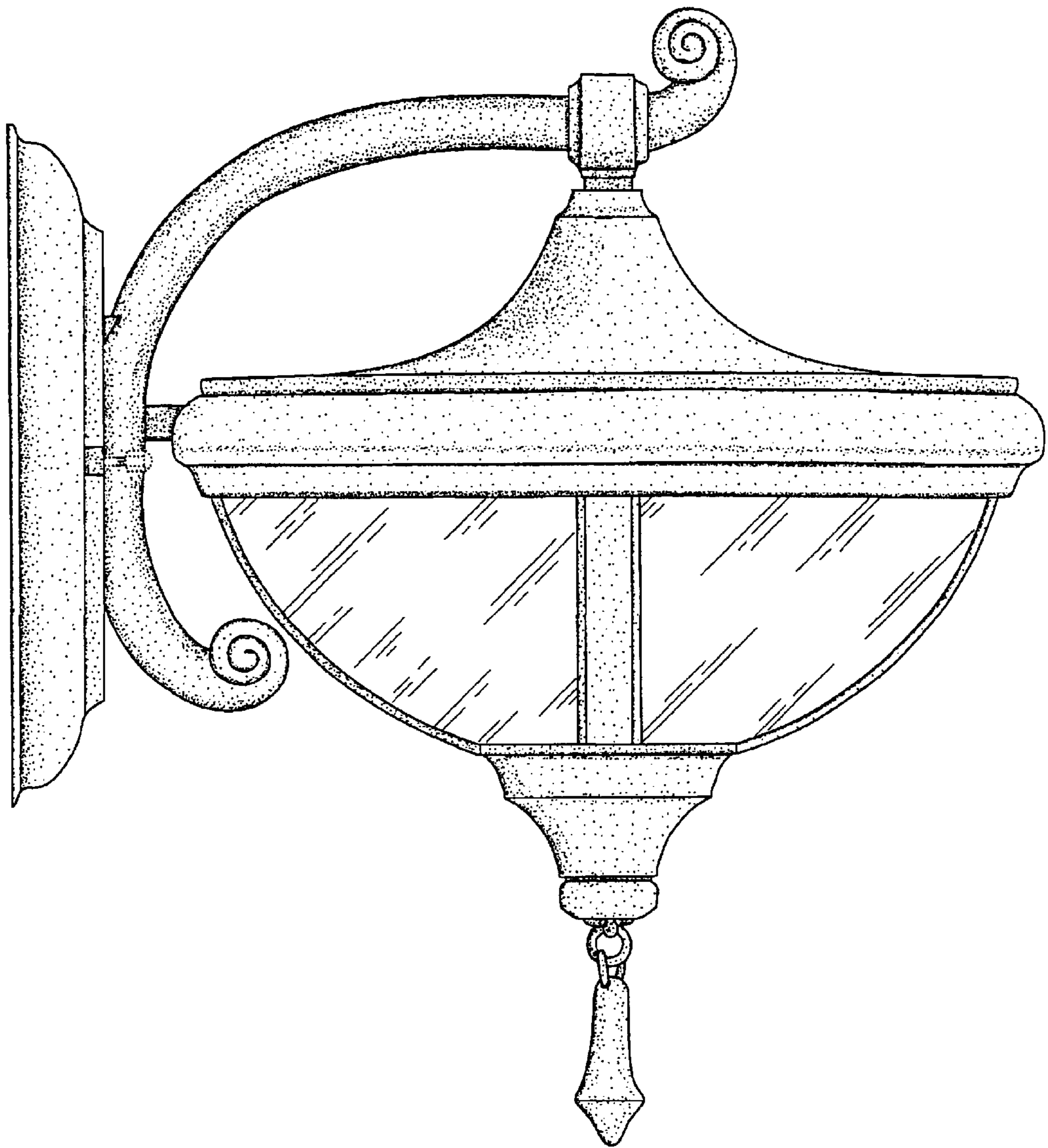

Fig. 2

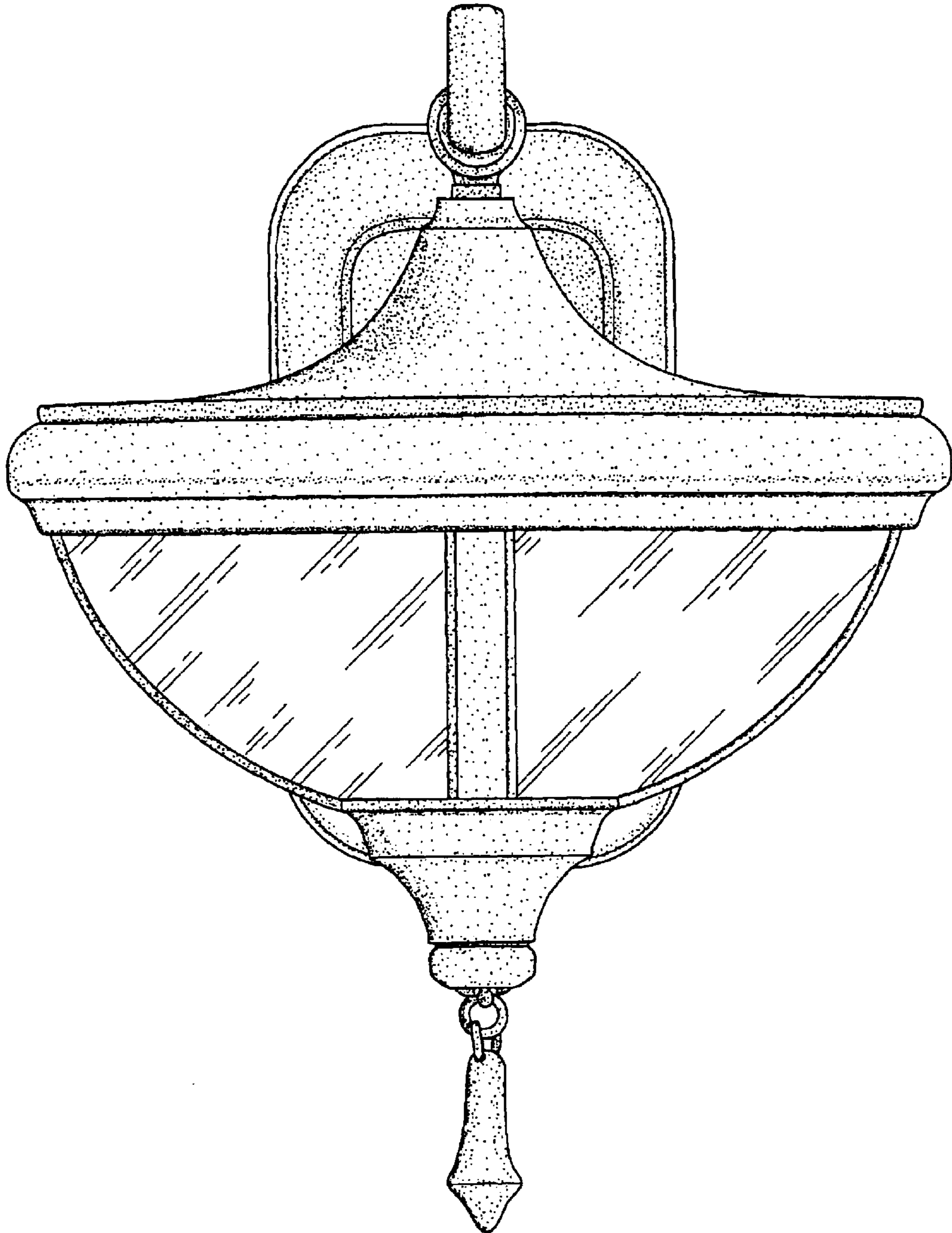

Fig. 3

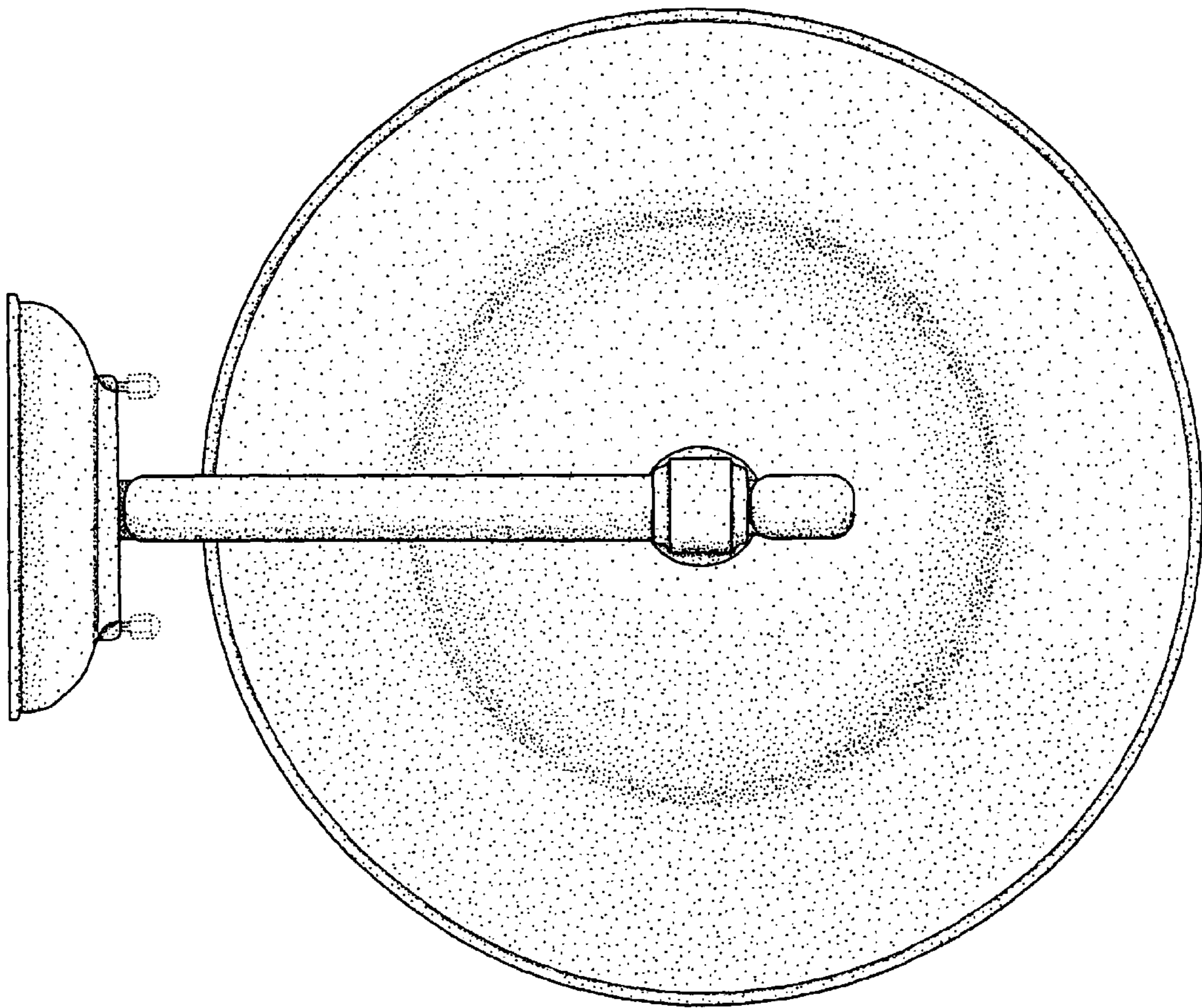

Fig. 4

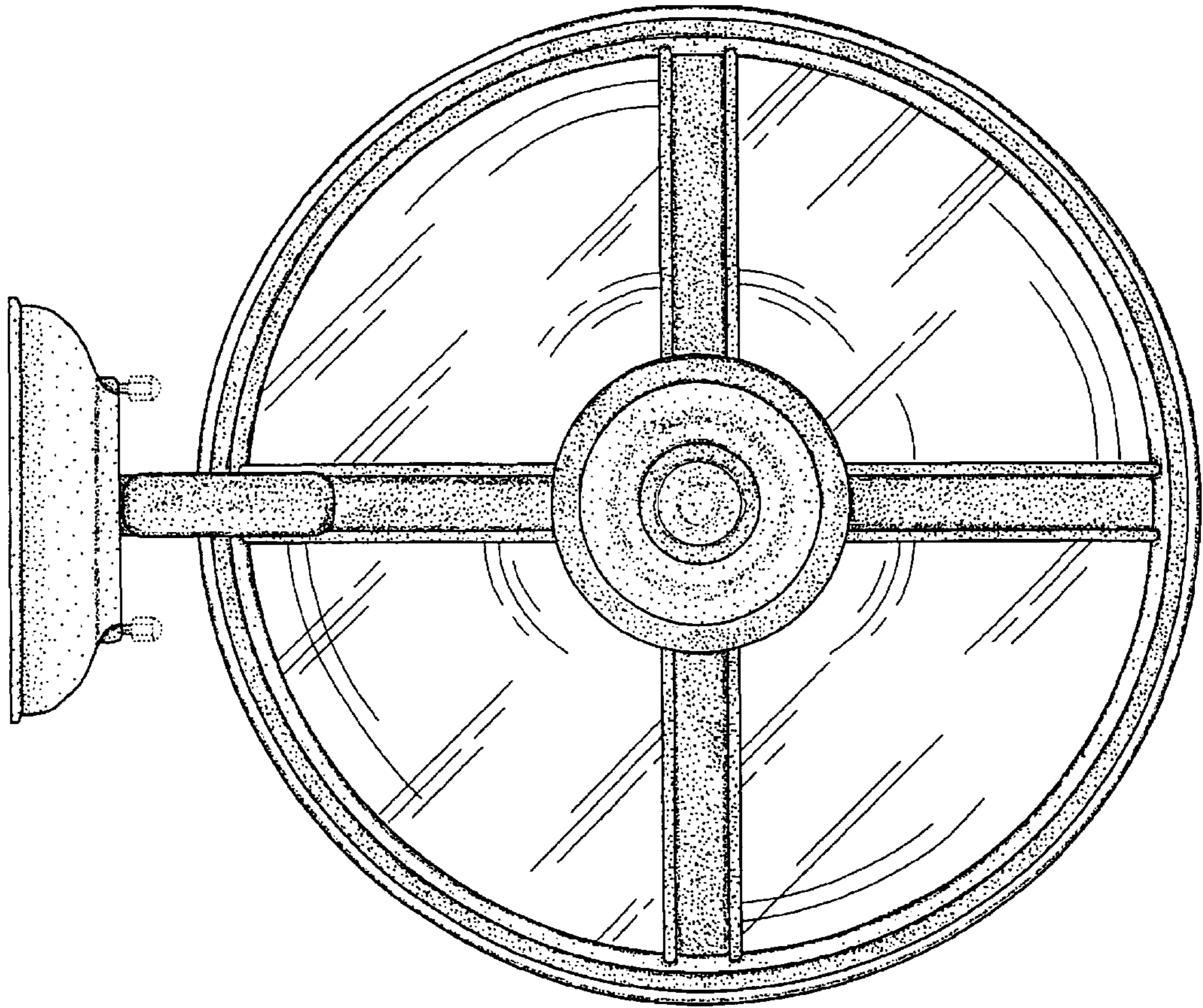

Fig. 5