



US00D490919S

(12) **United States Design Patent**
Wiesmeth

(10) **Patent No.:** **US D490,919 S**
(45) **Date of Patent:** **** Jun. 1, 2004**

(54) **FLASHLIGHT**

(75) Inventor: **Stefan R. Wiesmeth**, Brooklyn, NY
(US)

(73) Assignee: **Reel-Talk, Inc.**, Irvine, CA (US)

(**) Term: **14 Years**

(21) Appl. No.: **29/176,967**

(22) Filed: **Feb. 28, 2003**

(51) **LOC (7) Cl.** **26-02**

(52) **U.S. Cl.** **D26/37**

(58) **Field of Search** D26/37-50; 362/157,
362/158, 171-173, 183-208

(56) **References Cited**

U.S. PATENT DOCUMENTS

D244,796 S	*	6/1977	Staub	D26/49
D252,170 S	*	6/1979	Simmons	D26/49
D403,451 S	*	12/1998	Ting	D26/37

* cited by examiner

Primary Examiner—Marcus A. Jackson

(74) *Attorney, Agent, or Firm*—Cohen & Sakaguchi LLP

(57) **CLAIM**

The ornamental design for the flashlight, as shown and described.

DESCRIPTION

FIG. 1 is a perspective view of the flashlight showing a portion of the top of the flashlight and a portion of the right side of the flashlight;

FIG. 2 is a perspective view of the flashlight, rotated around its longitudinal axis approximately 45 degrees clockwise from the position shown in FIG. 1, thus showing the right side of the flashlight and a portion of the bottom of the flashlight;

FIG. 3 is a perspective view of the flashlight, rotated around its longitudinal axis approximately 45 degrees clockwise from the position shown in FIG. 2, thus showing the right side of the flashlight and more of a portion of the bottom of the flashlight than shown in FIG. 2;

FIG. 4 is a perspective view of the flashlight, rotated around its longitudinal axis approximately 45 degrees clockwise from the position shown in FIG. 3, thus showing a portion of the right side of the flashlight, the bottom of the flashlight, and a portion of the left side of the flashlight;

FIG. 5 is a perspective view of the flashlight, rotated around its longitudinal axis approximately 45 degrees clockwise from the position shown in FIG. 4, thus showing the bottom of the flashlight, and more of a portion of the left side of the flashlight than shown in FIG. 4;

FIG. 6 is a perspective view of the flashlight, rotated around its longitudinal axis approximately 45 degrees clockwise from the position shown in FIG. 5, thus showing the left side of the flashlight;

FIG. 7 is a perspective view of the flashlight, rotated around its longitudinal axis approximately 45 degrees clockwise from the position shown in FIG. 6, thus showing a portion of the left side of the flashlight, the top of the flashlight, and a portion of the right side of the flashlight;

FIG. 8 is a perspective view of the flashlight, rotated around its longitudinal axis approximately 45 degrees clockwise from the position shown in FIG. 7, thus showing less of a portion of the left side of the flashlight than shown in FIG. 7, the top of the flashlight, and more of a portion of the right side of the flashlight than shown in FIG. 7;

FIG. 9 is a longitudinal elevational view of the right side of the flashlight;

FIG. 10 is a longitudinal elevational view of the flashlight, rotated around its horizontal axis approximately 180 degrees from the position shown in FIG. 9, thus showing the left side of the flashlight;

FIG. 11 is a longitudinal elevational view of the flashlight, rotated around its longitudinal axis approximately 90 degrees counterclockwise from the position shown in FIG. 9, thus showing the top of the flashlight and a portion of both the right and left sides of the flashlight;

FIG. 12 is a longitudinal elevational view of the flashlight, rotated around its longitudinal axis approximately 90 degrees clockwise from the position shown in FIG. 9, thus showing the bottom of the flashlight and a portion of both the right and left sides of the flashlight;

FIG. 13 is an elevational view of the back of the flashlight; FIGS. 14A through 14e are elevational views of the front of the flashlight, showing various arrangements and types of lights in broken lines;

FIG. 15 is a partial longitudinal cross-sectional view of a proximal portion of the flashlight;

FIG. 16 is a partial longitudinal cross-sectional view of a distal portion of the flashlight;

FIG. 17 is a partial horizontal cross-sectional view of a distal portion of the flashlight; and,

FIG. 18 is a partial horizontal cross-sectional view of a proximal portion of the flashlight.

1 Claim, 8 Drawing Sheets

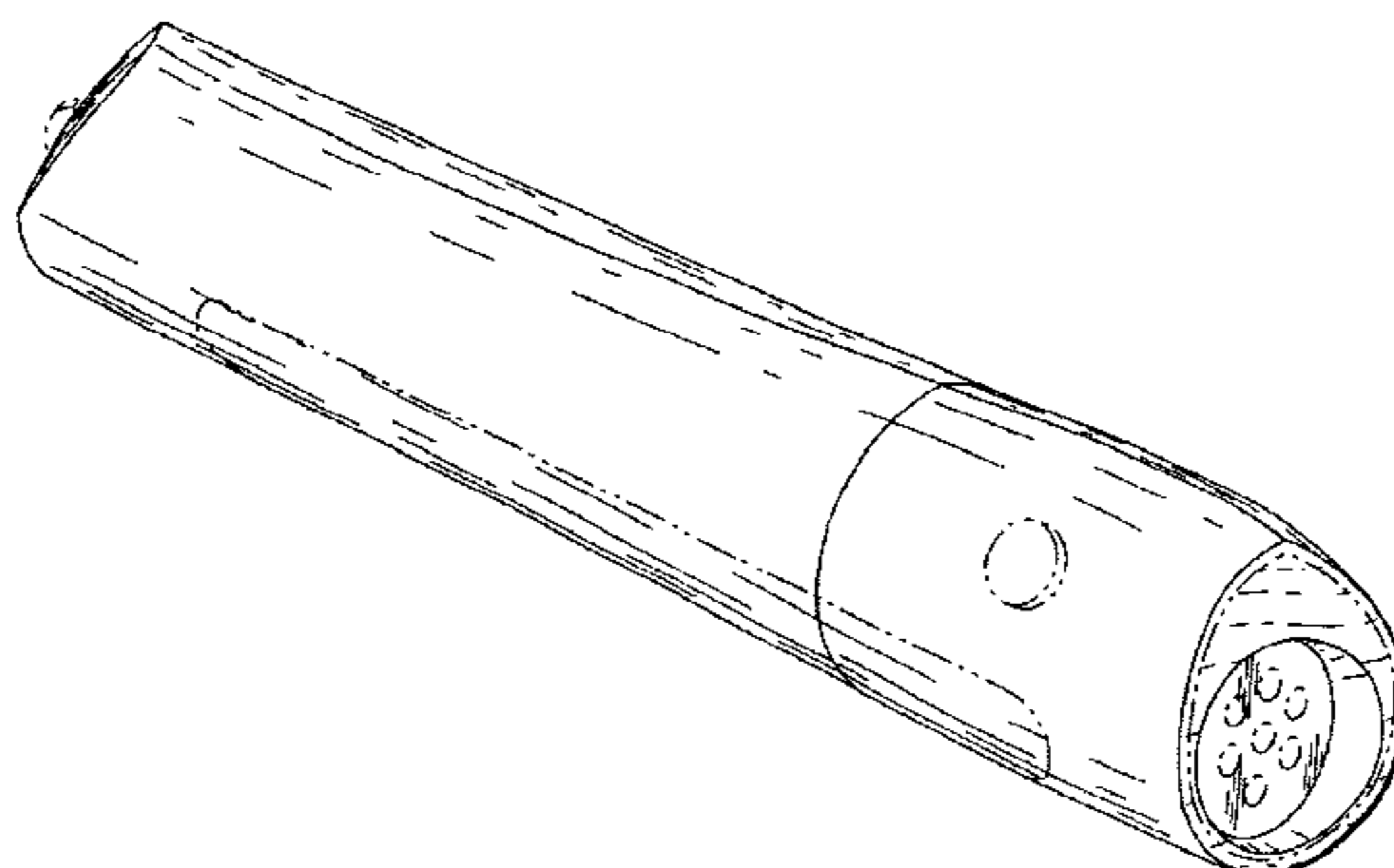

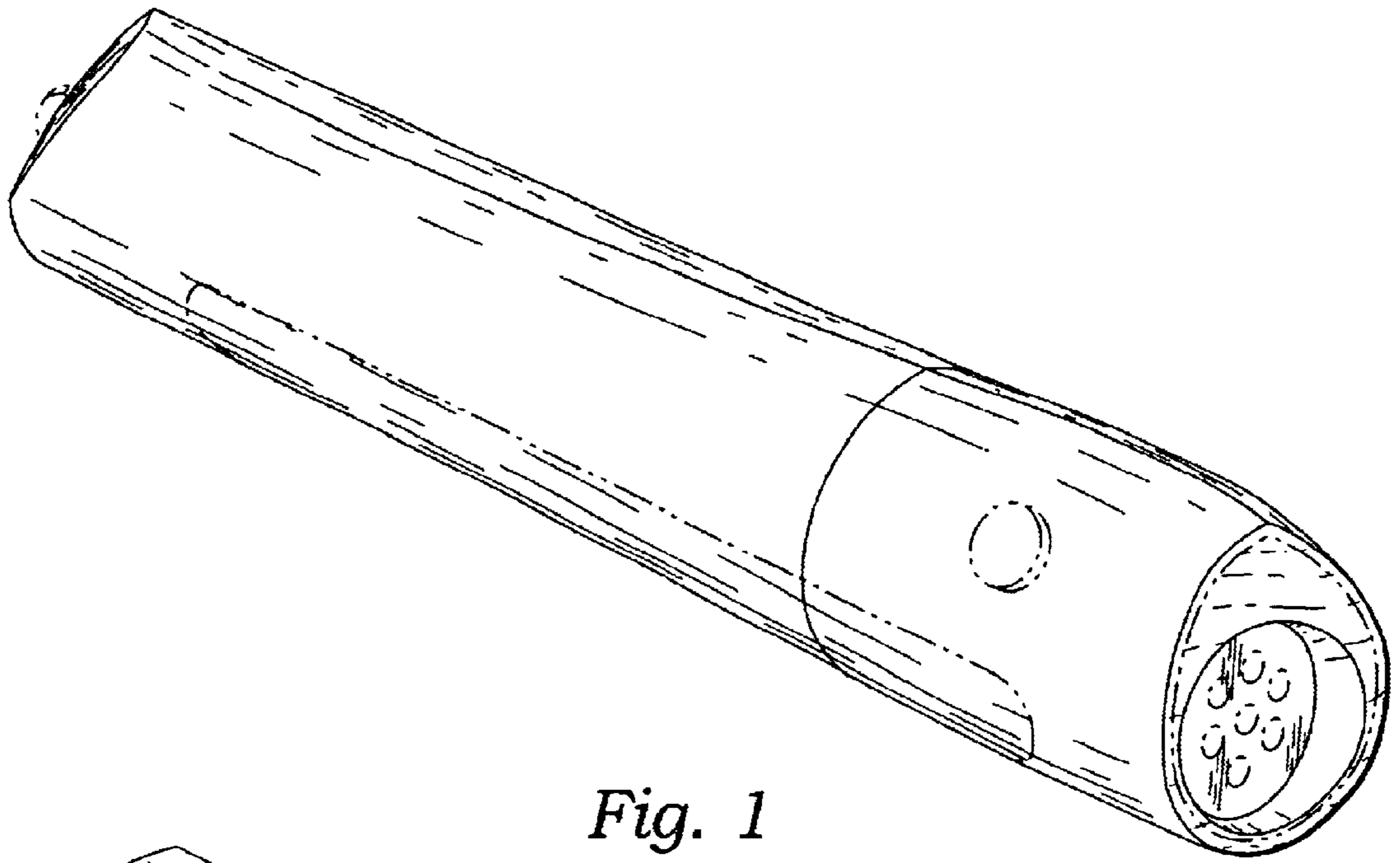

Fig. 1

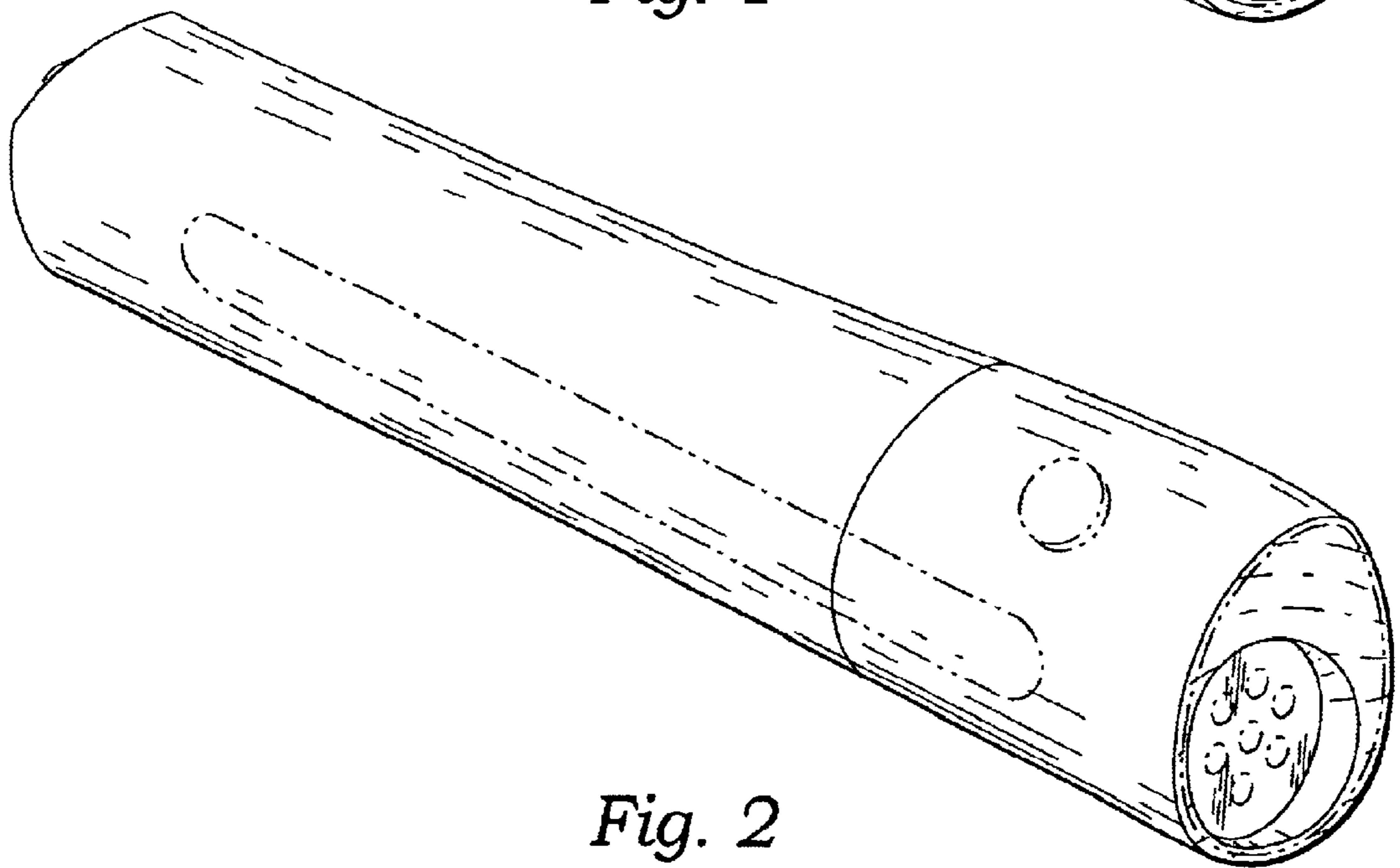

Fig. 2

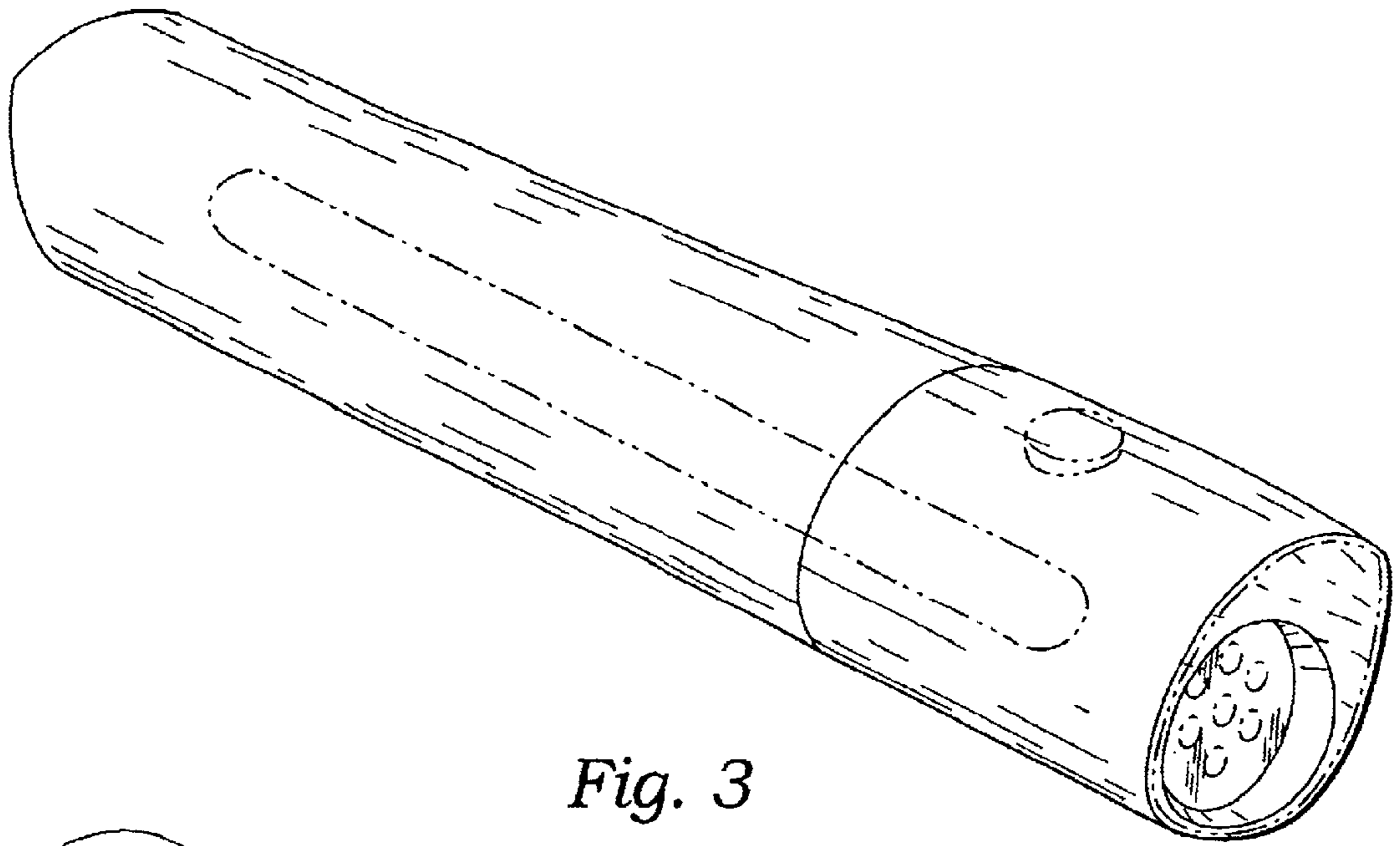

Fig. 3

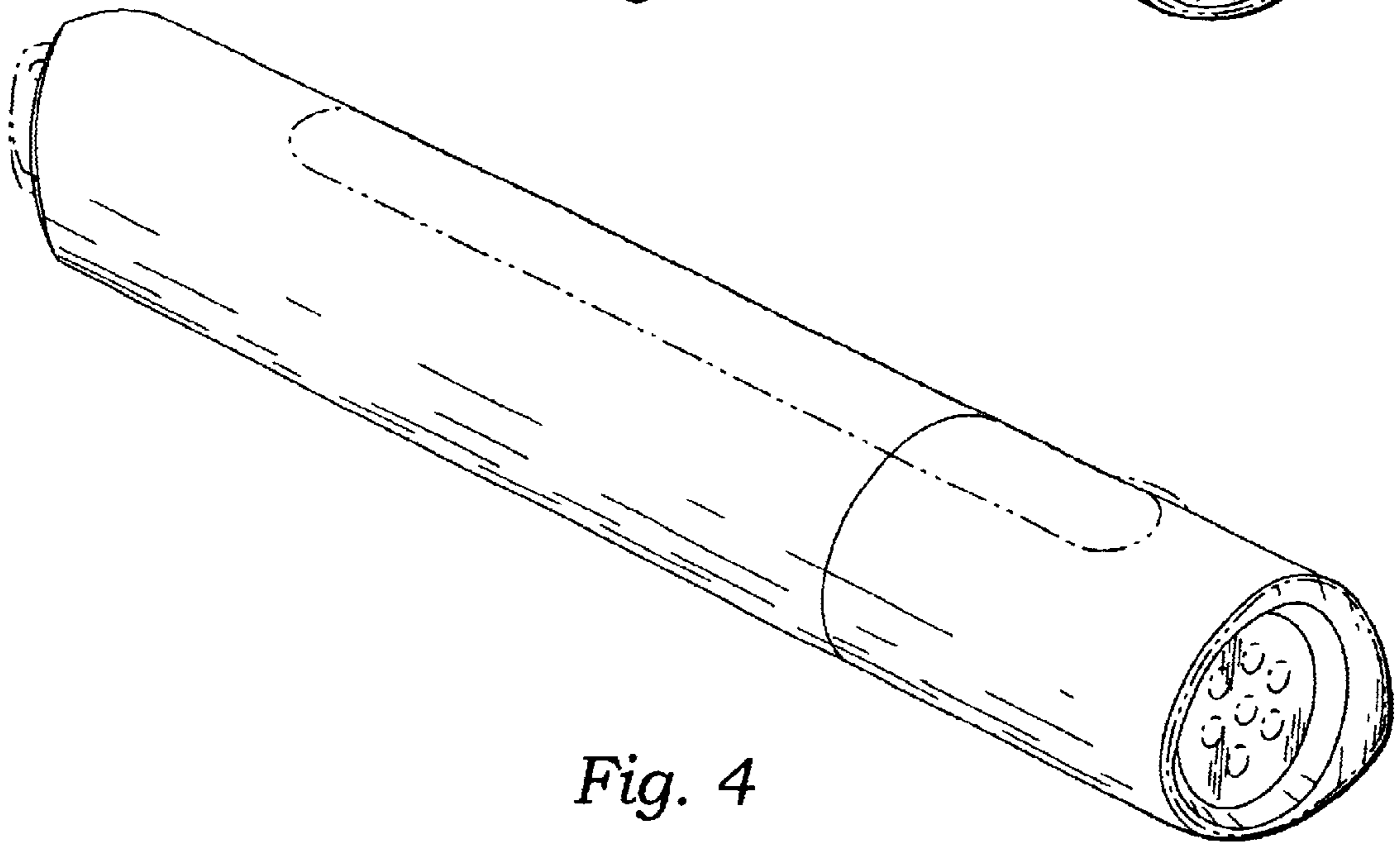

Fig. 4

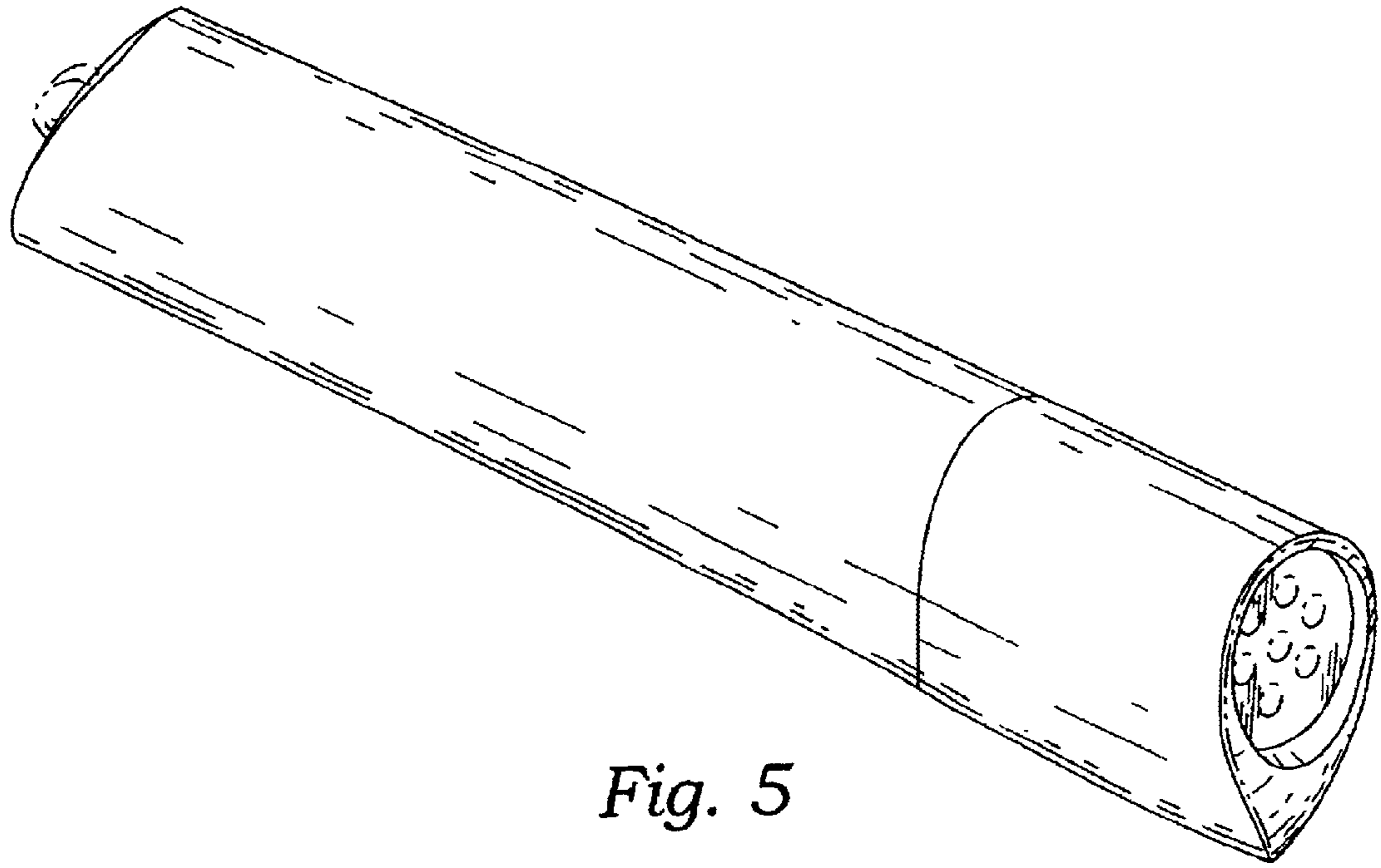

Fig. 5

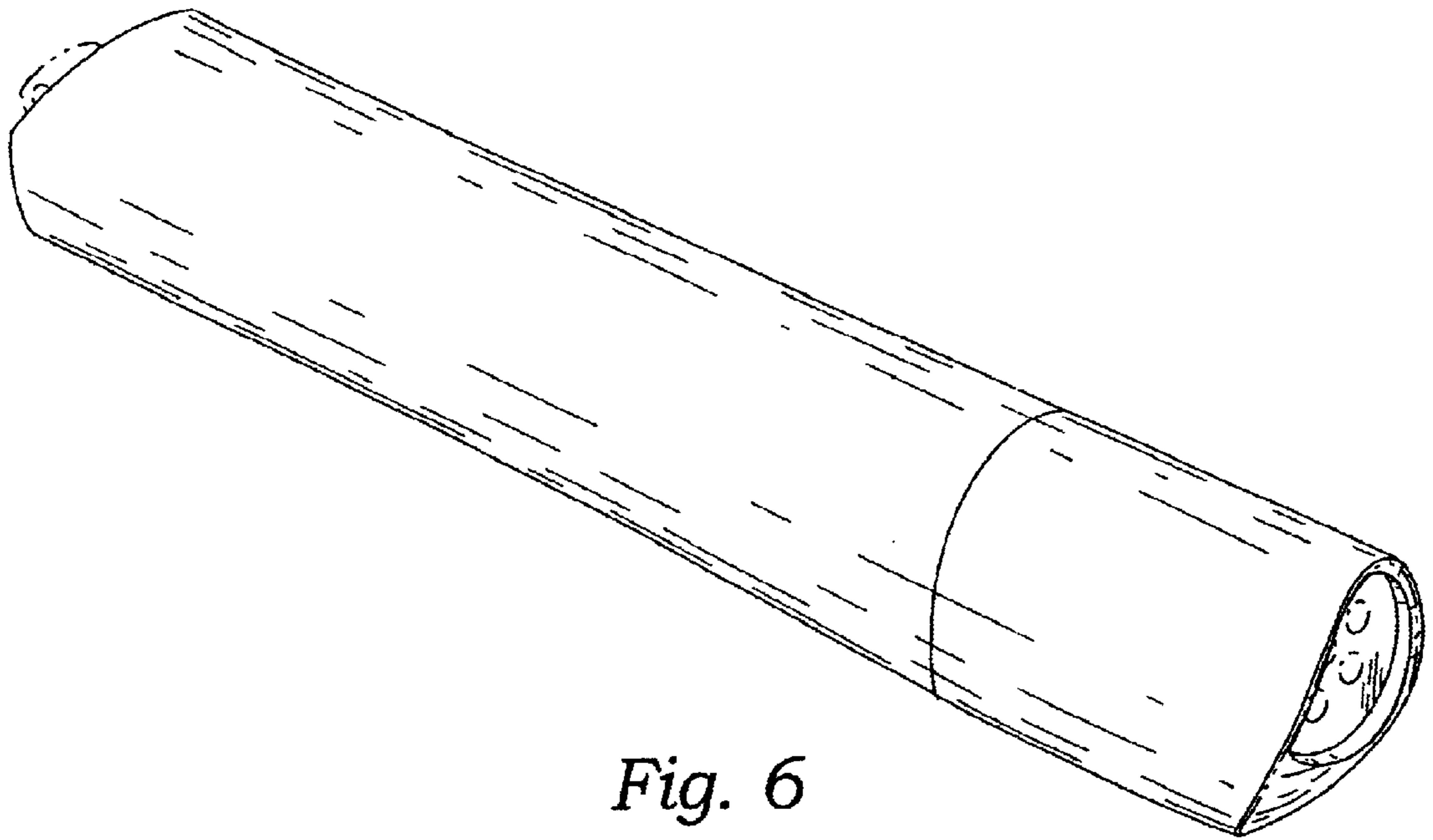

Fig. 6

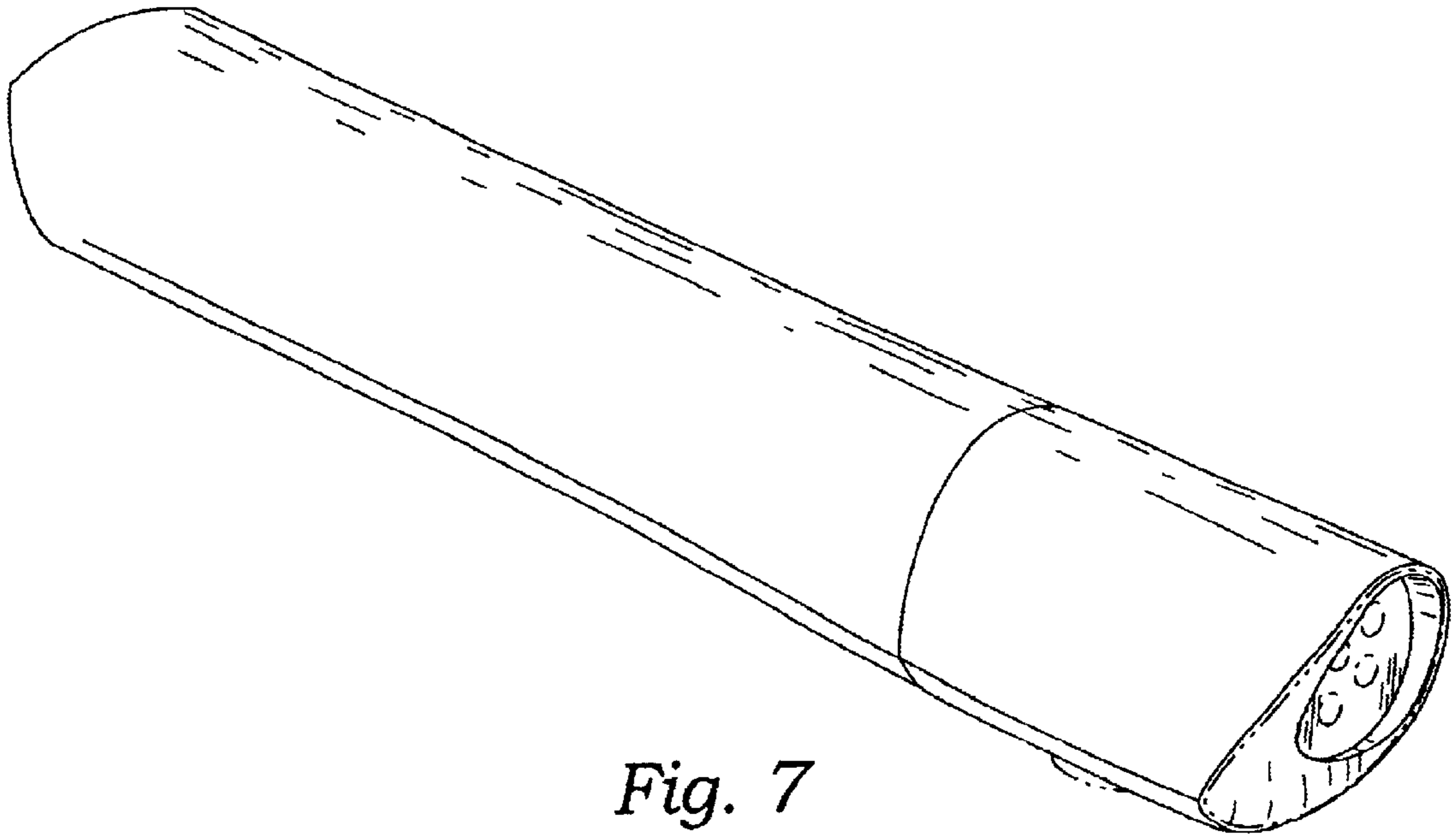

Fig. 7

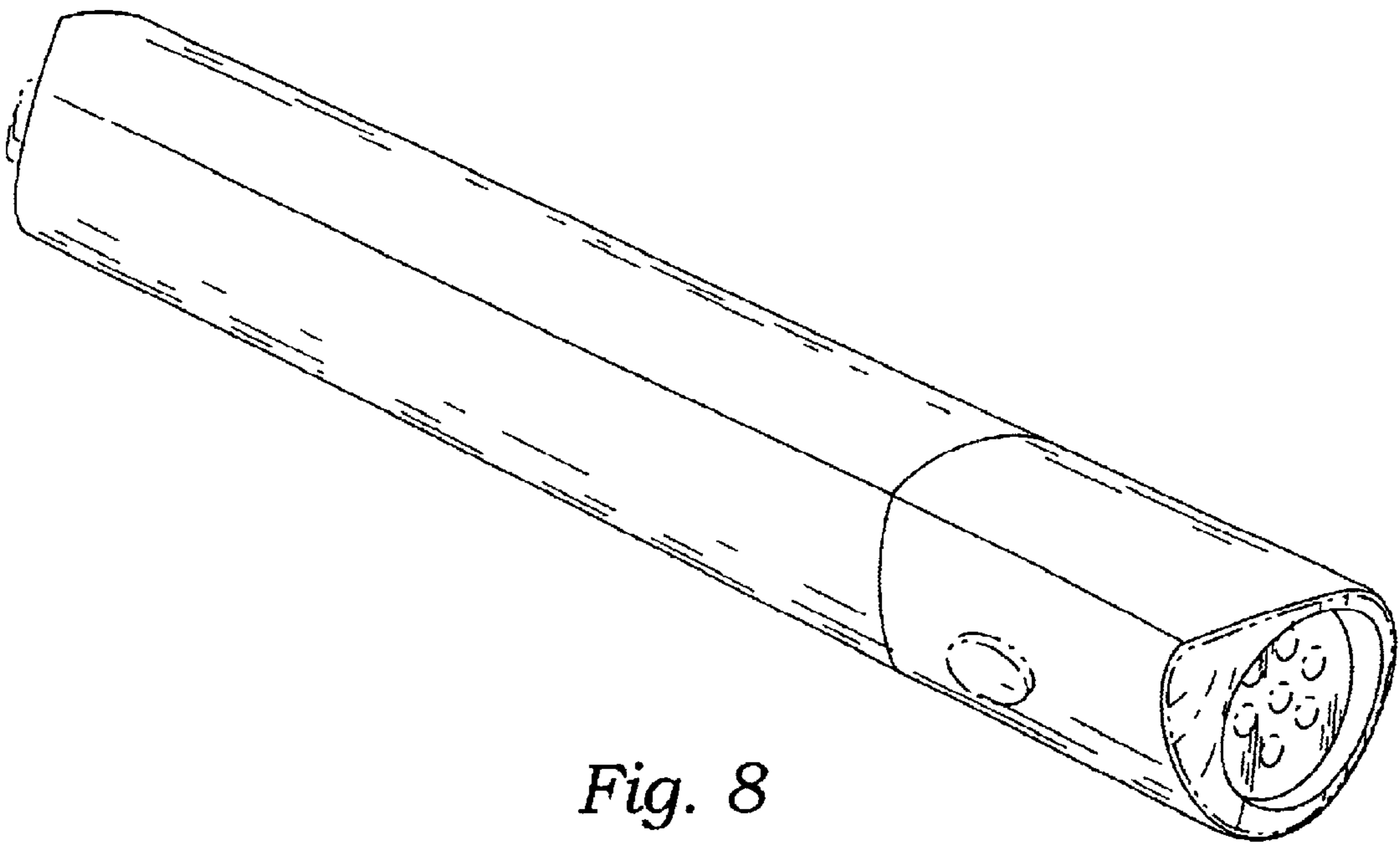

Fig. 8

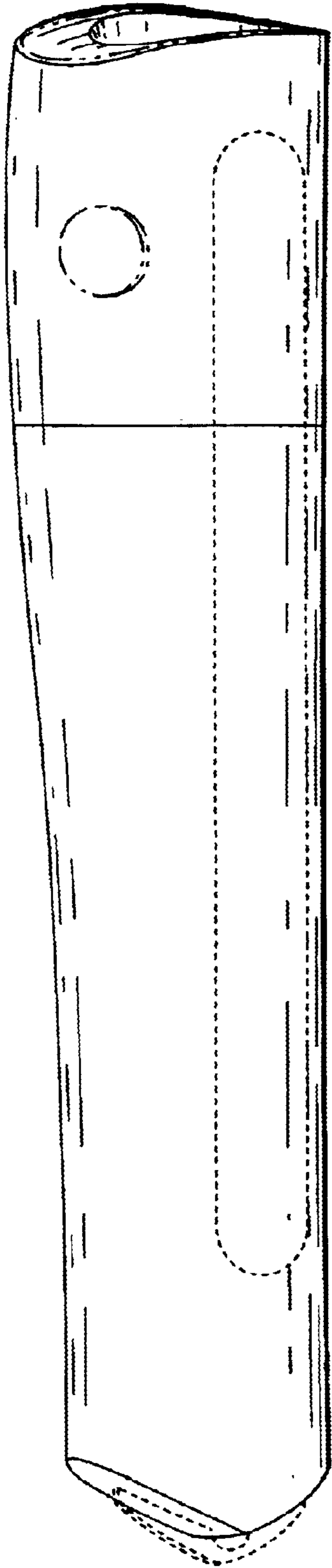

Fig. 9

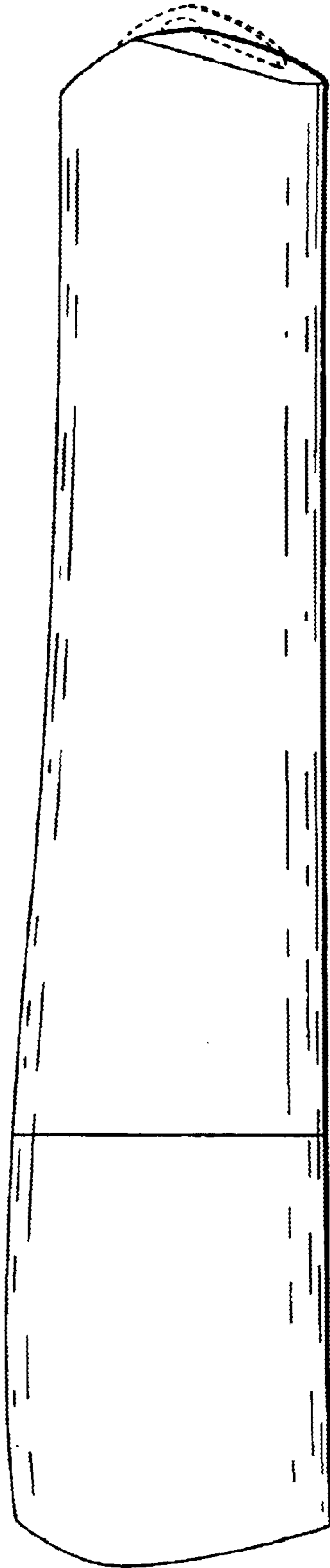

Fig. 10

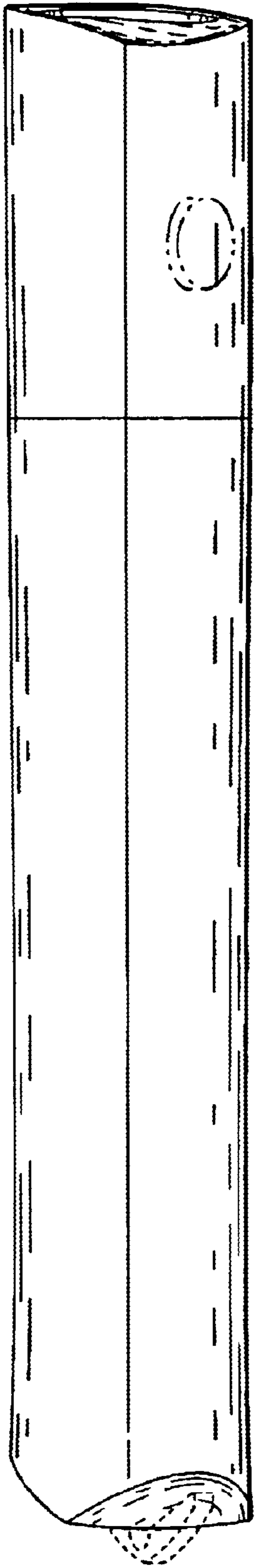

Fig. 11

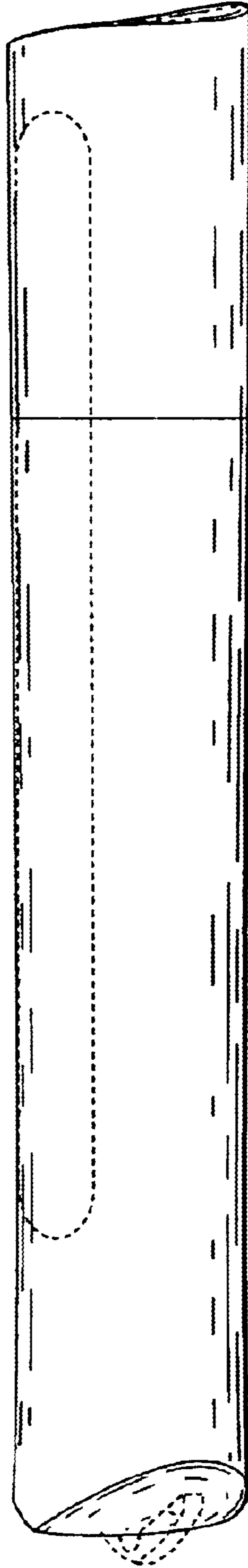

Fig. 12

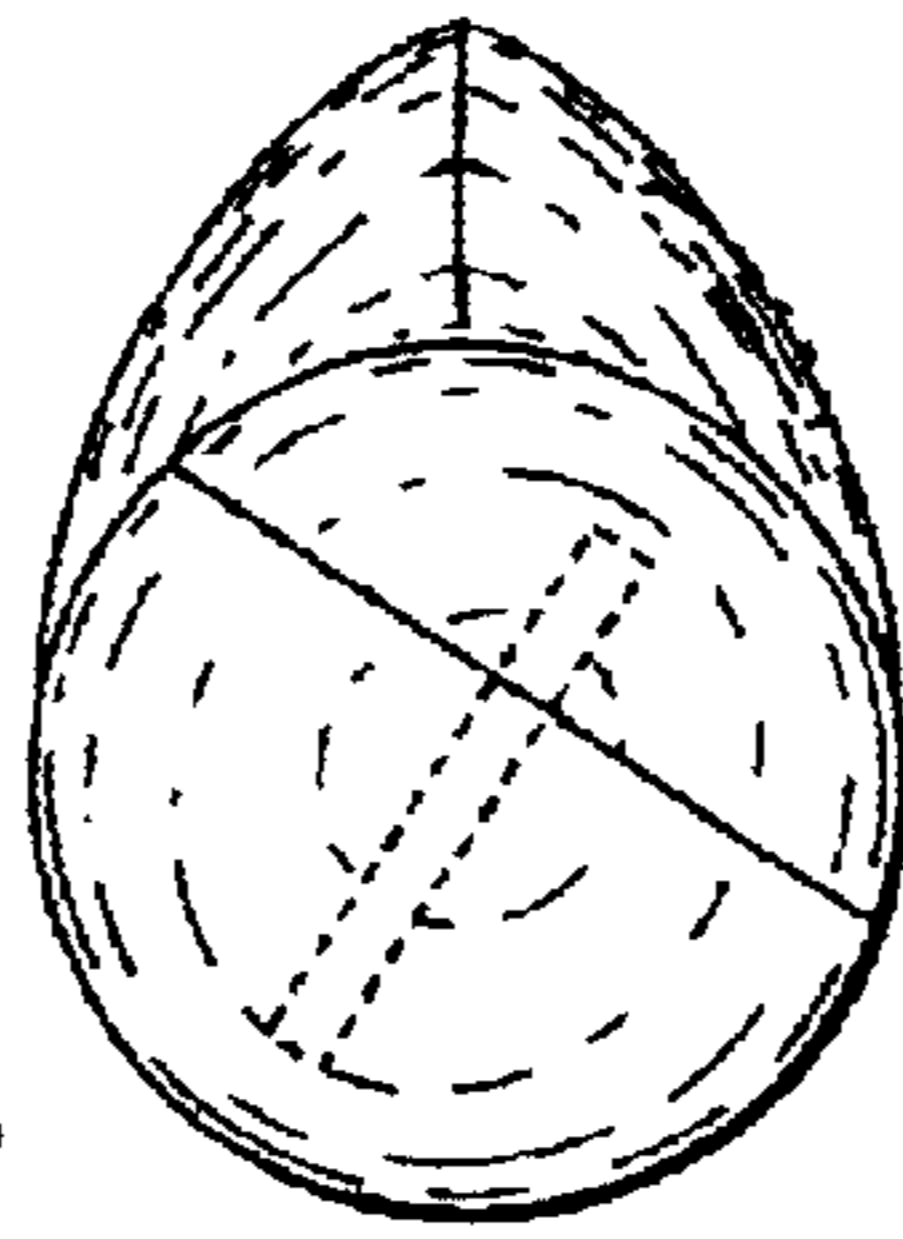

Fig. 13

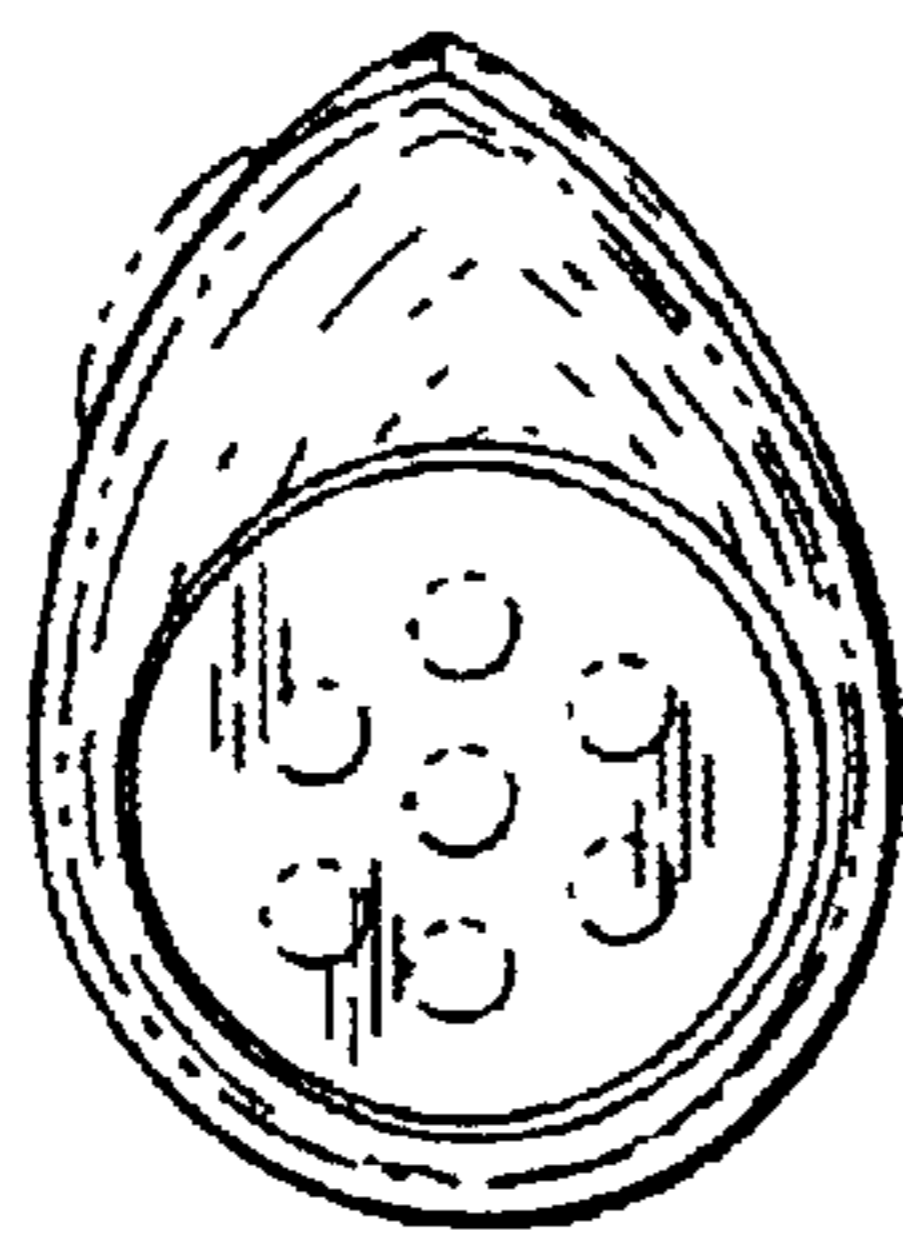

Fig. 14a

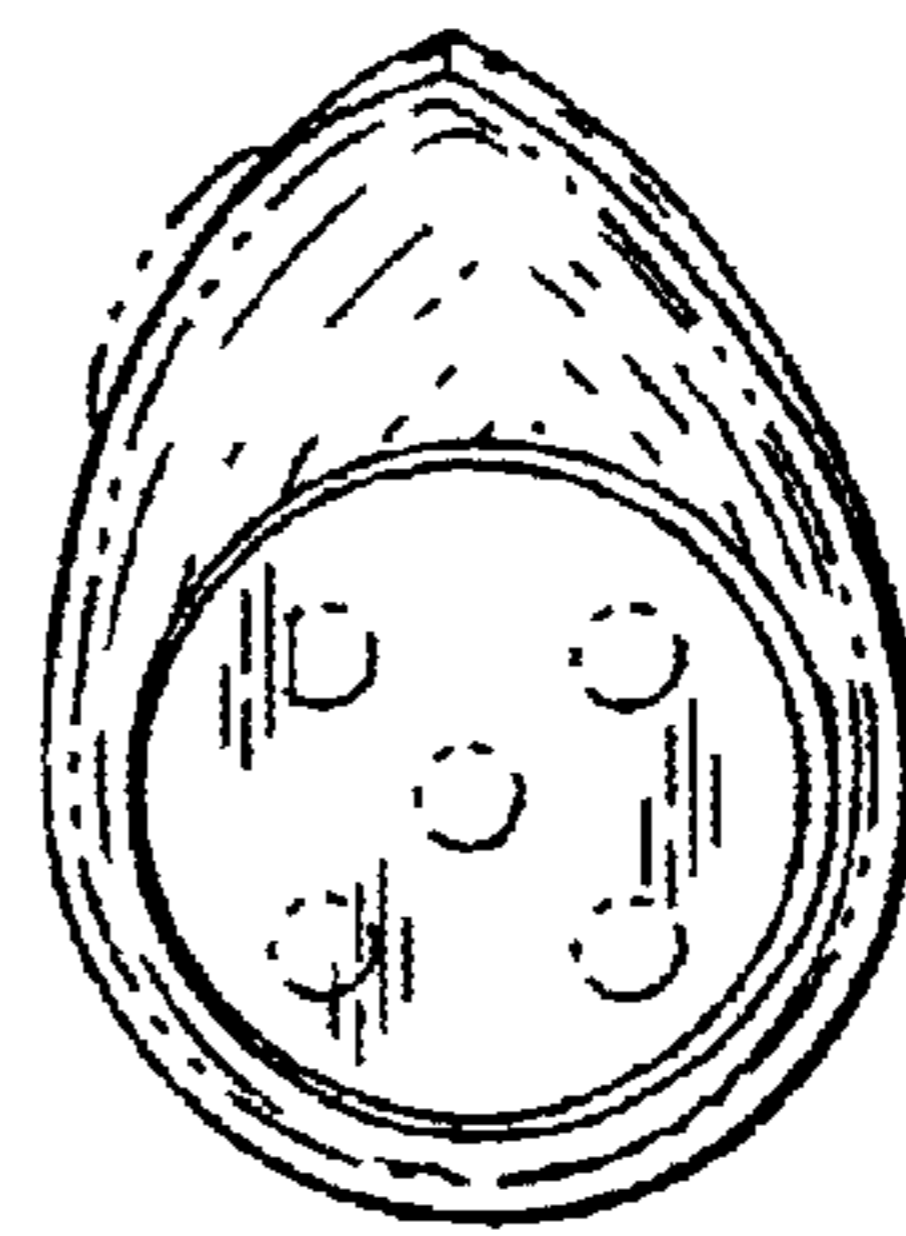

Fig. 14b

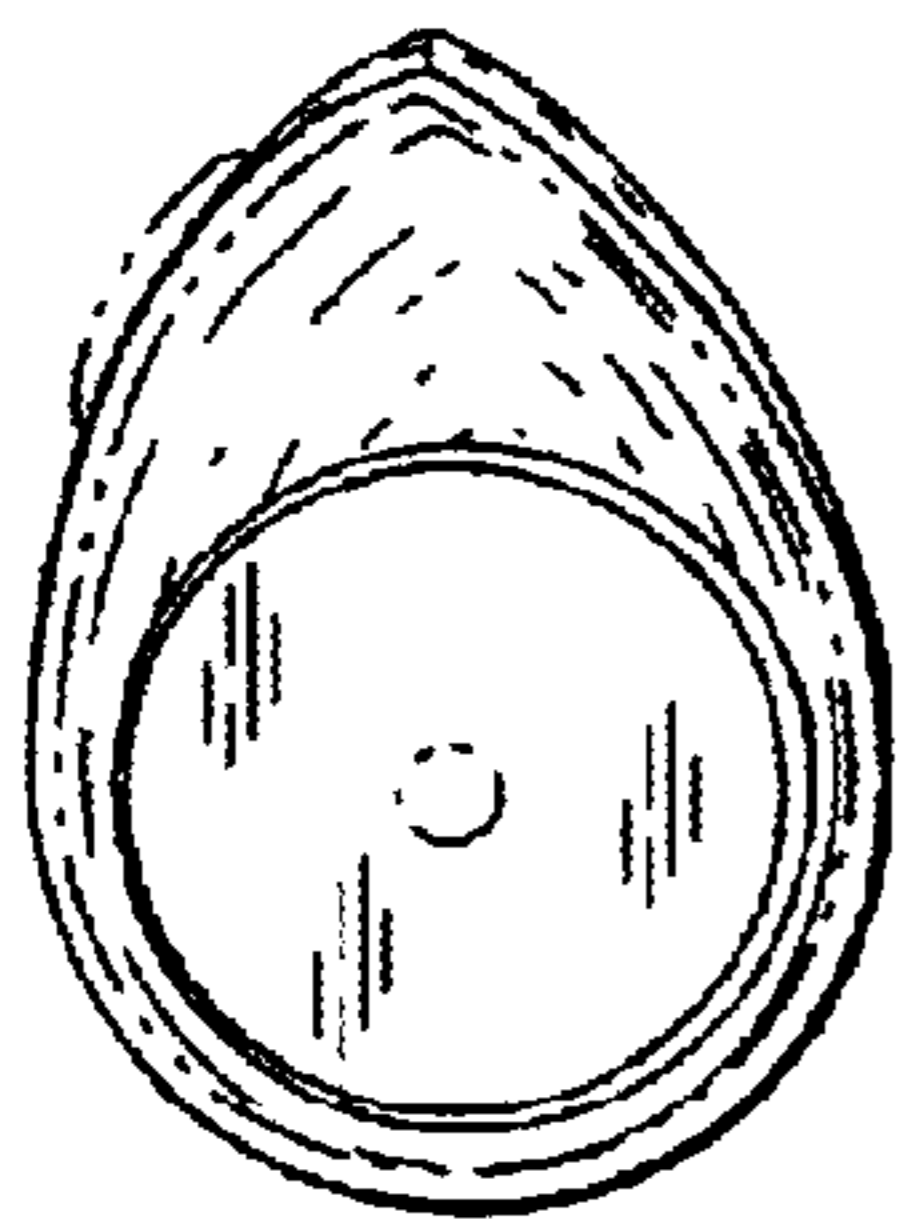

Fig. 14c

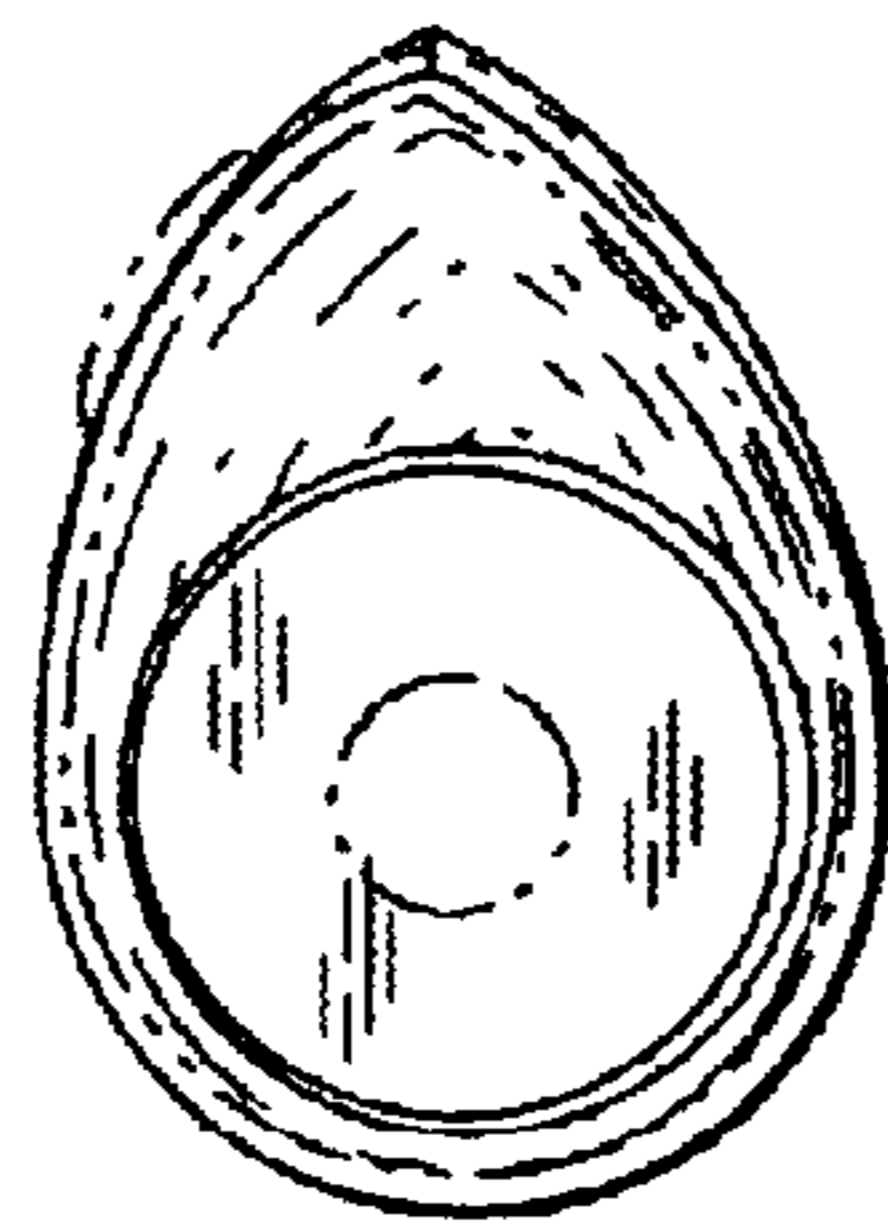

Fig. 14d

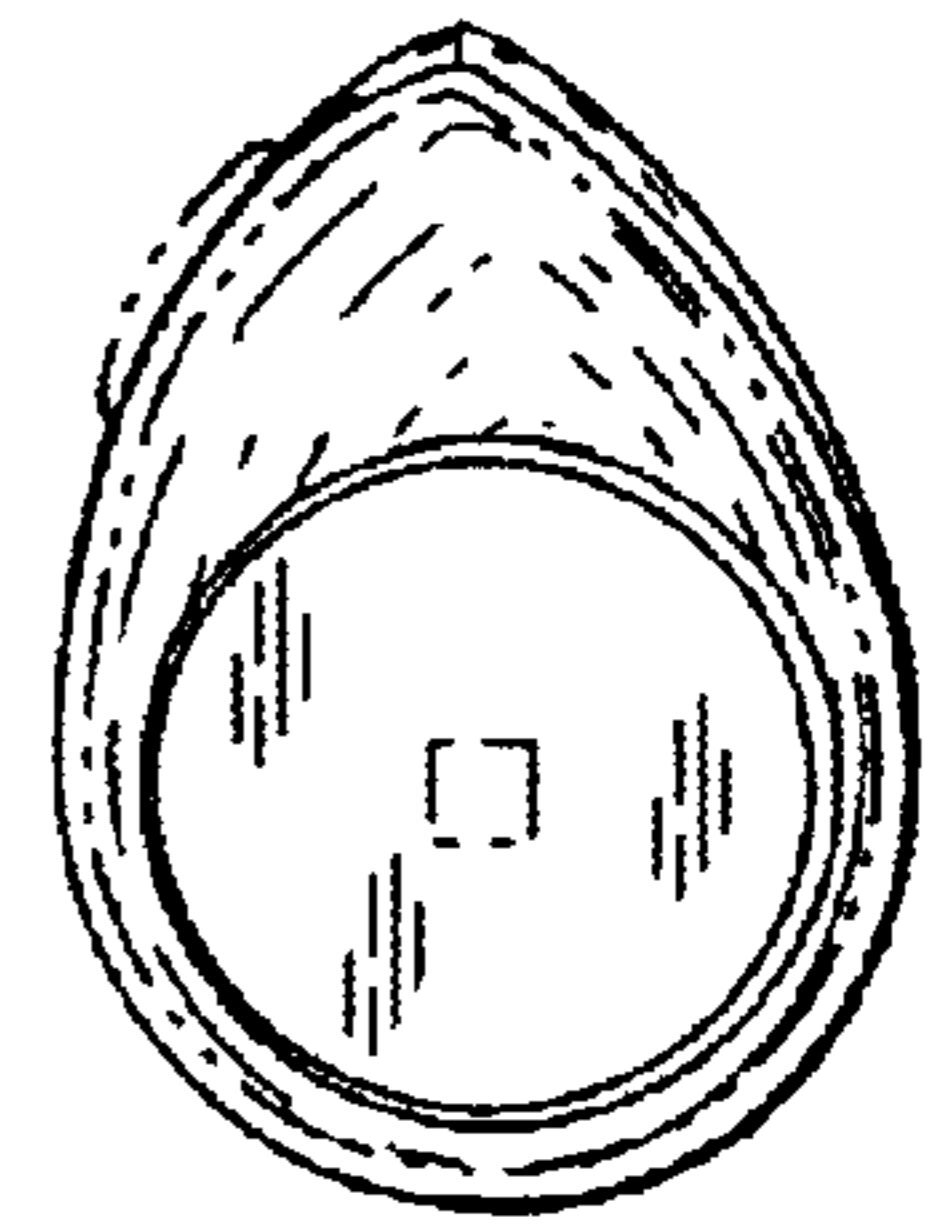

Fig. 14e

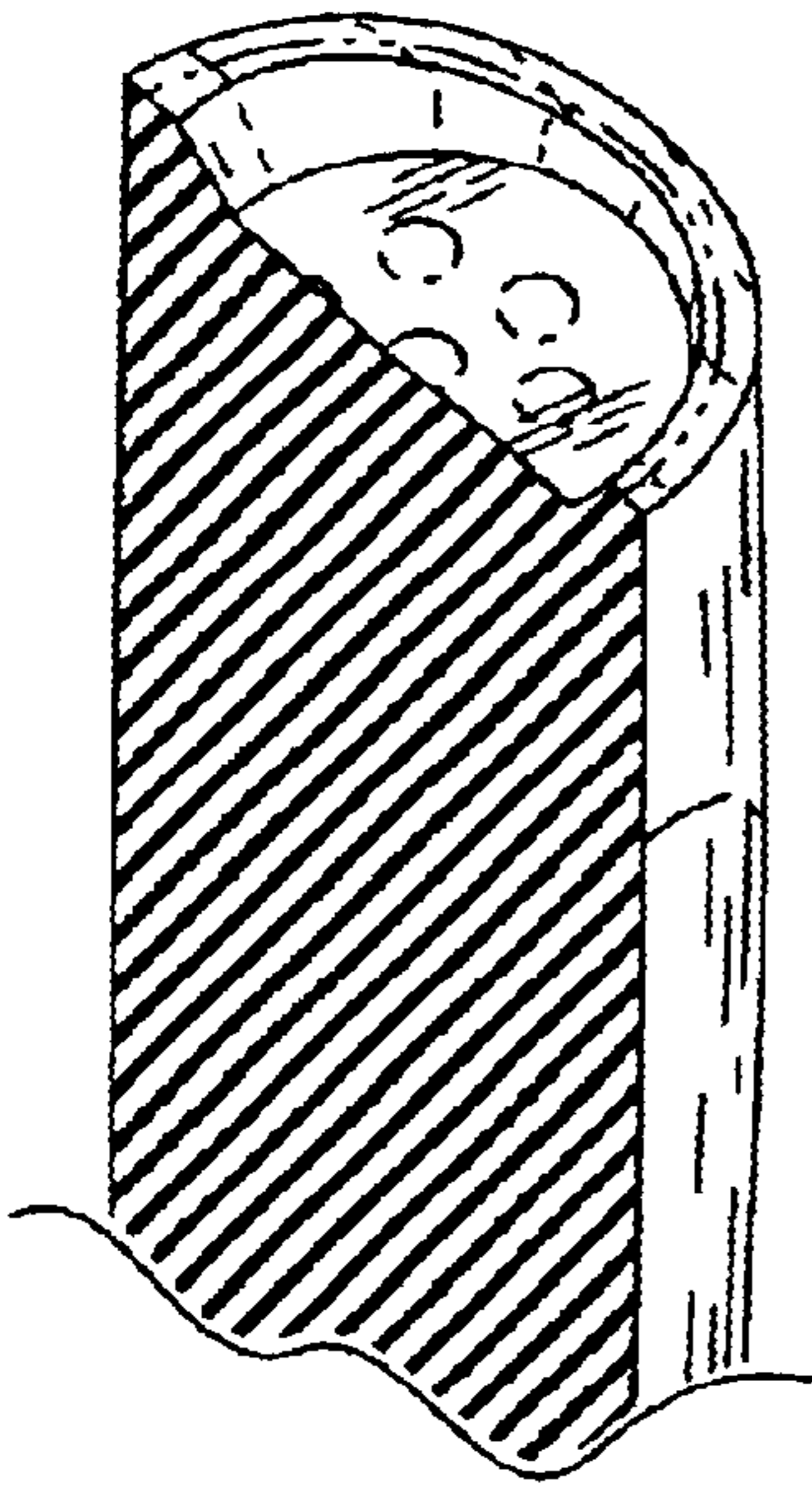

Fig. 15

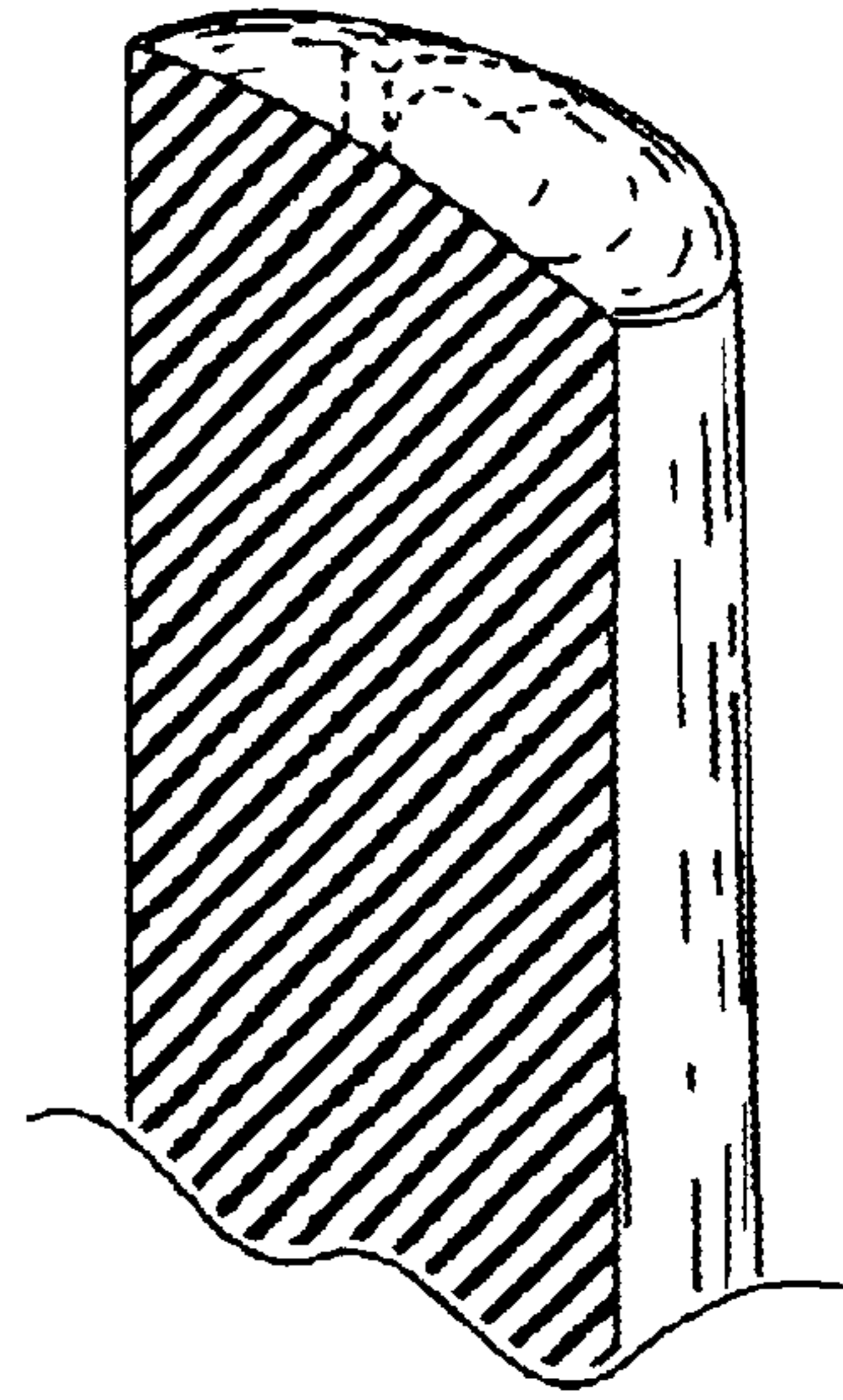

Fig. 16

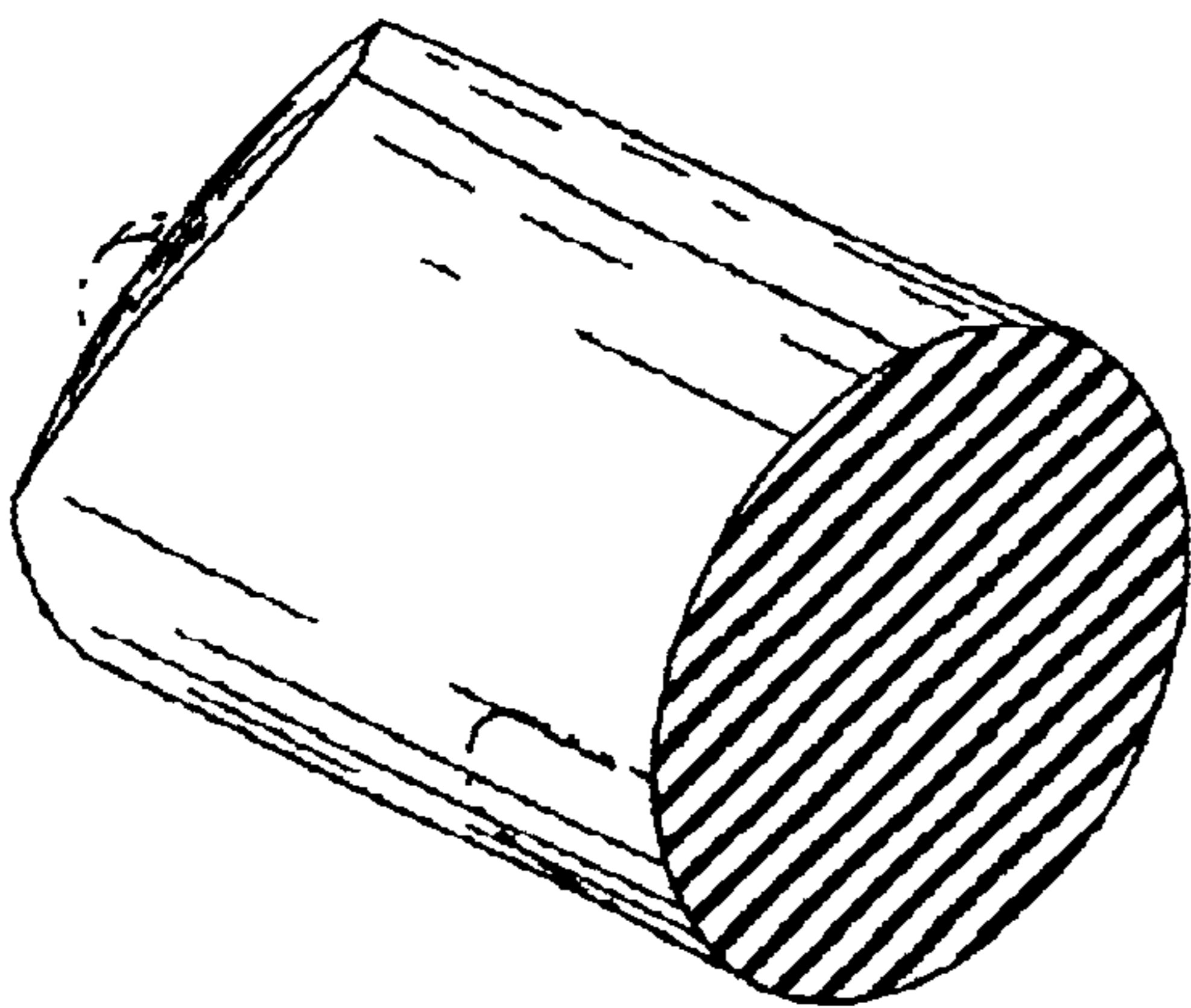

Fig. 17

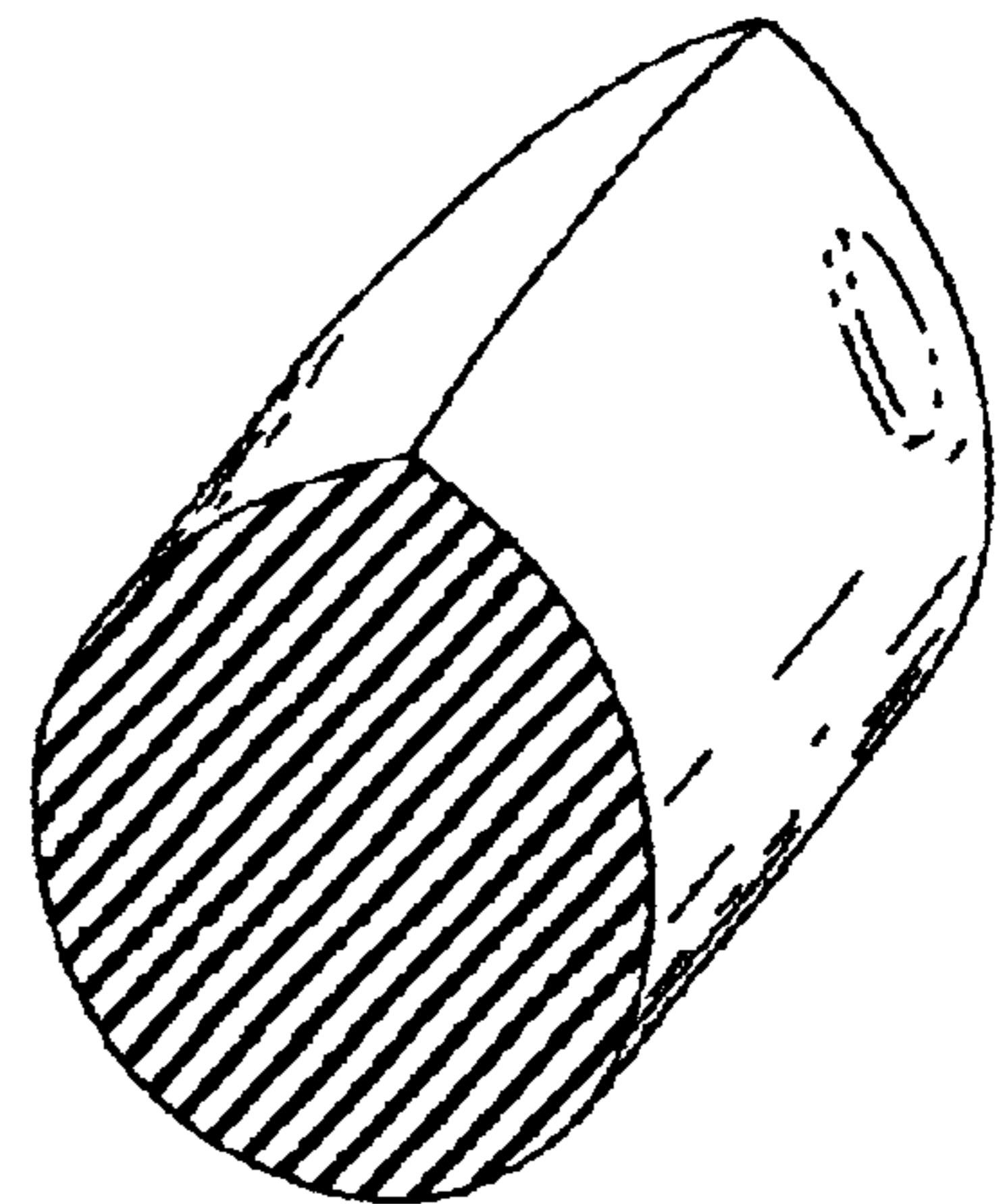

Fig. 18