



US00D490896S

(12) **United States Design Patent**
Bogazzi

(10) **Patent No.:** **US D490,896 S**

(45) **Date of Patent:** **** Jun. 1, 2004**

(54) **INSTRUMENT HANDLE**

(75) Inventor: **Marco Bogazzi**, New Haven, CT (US)

(73) Assignee: **Tyco Healthcare Group LP**, Norwalk, CT (US)

(**) Term: **14 Years**

(21) Appl. No.: **29/177,605**

(22) Filed: **Mar. 11, 2003**

(51) **LOC (7) Cl.** **24-02**

(52) **U.S. Cl.** **D24/133; D24/143; D24/145; D24/146; D24/147**

(58) **Field of Search** **D24/133, 146, D24/145, 147, 143; 606/170, 1, 45, 46, 205, 208; D8/300, 301, 307, 310**

(56) **References Cited**

U.S. PATENT DOCUMENTS

5,669,875 A * 9/1997 van Eerdenburg 606/205
D385,350 S * 10/1997 Furnish D24/133

6,605,105 B1 * 8/2003 Cuschieri et al. 606/208
2003/0120272 A1 * 6/2003 Schneider et al. 606/170

* cited by examiner

Primary Examiner—Ian Simmons

(57) **CLAIM**

The ornamental design for an instrument handle, as shown and described.

DESCRIPTION

FIG. 1 is a perspective view of the instrument handle showing my new design;
FIG. 2 is a left side view thereof;
FIG. 3 is a right side view thereof;
FIG. 4 is a top view thereof;
FIG. 5 is a bottom view thereof;
FIG. 6 is a front view thereof; and,
FIG. 7 is a rear view thereof.

The broken lines showing in FIGS. 1–6 are for illustrative purposes only and form no part of the claimed design.

1 Claim, 3 Drawing Sheets

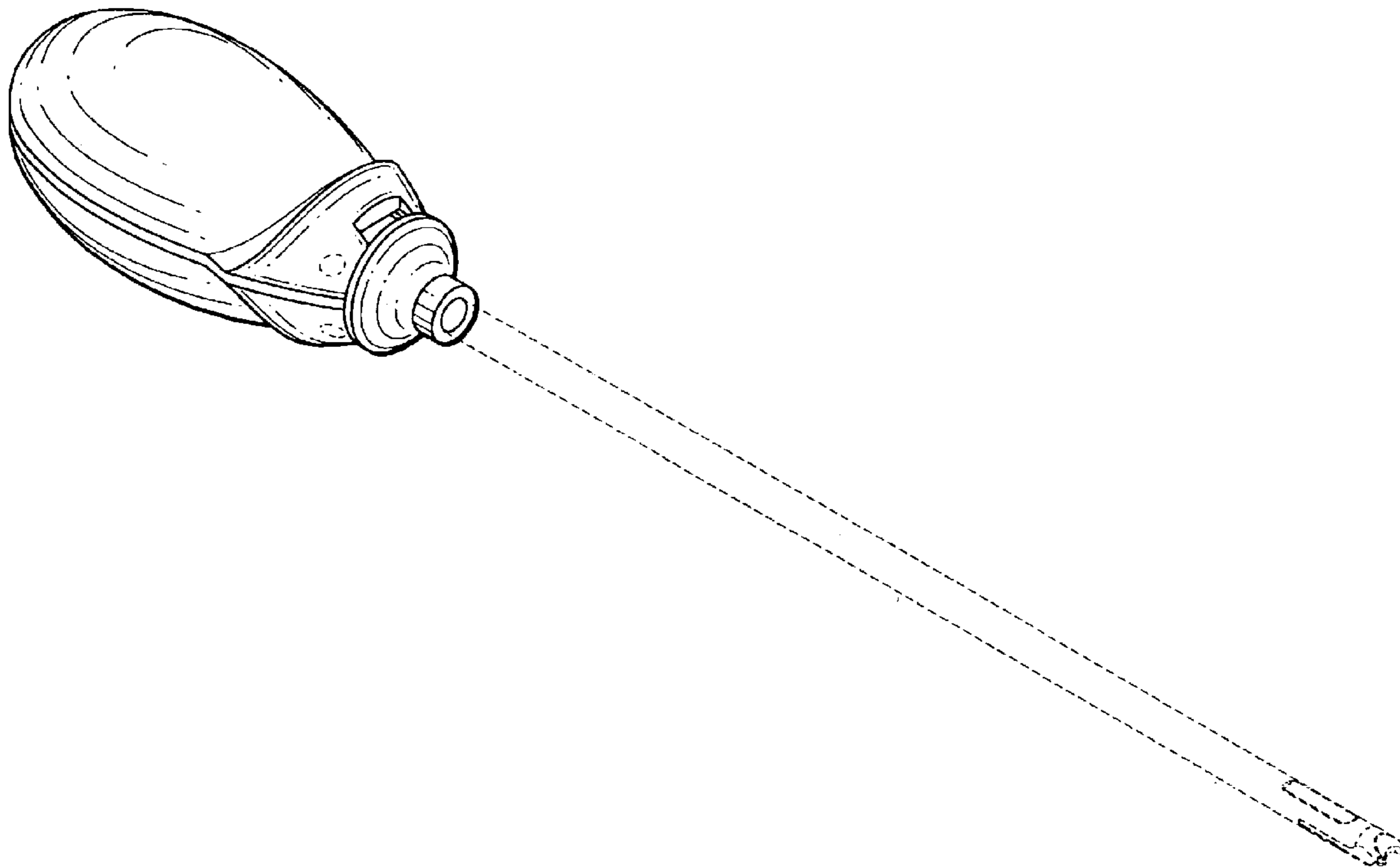

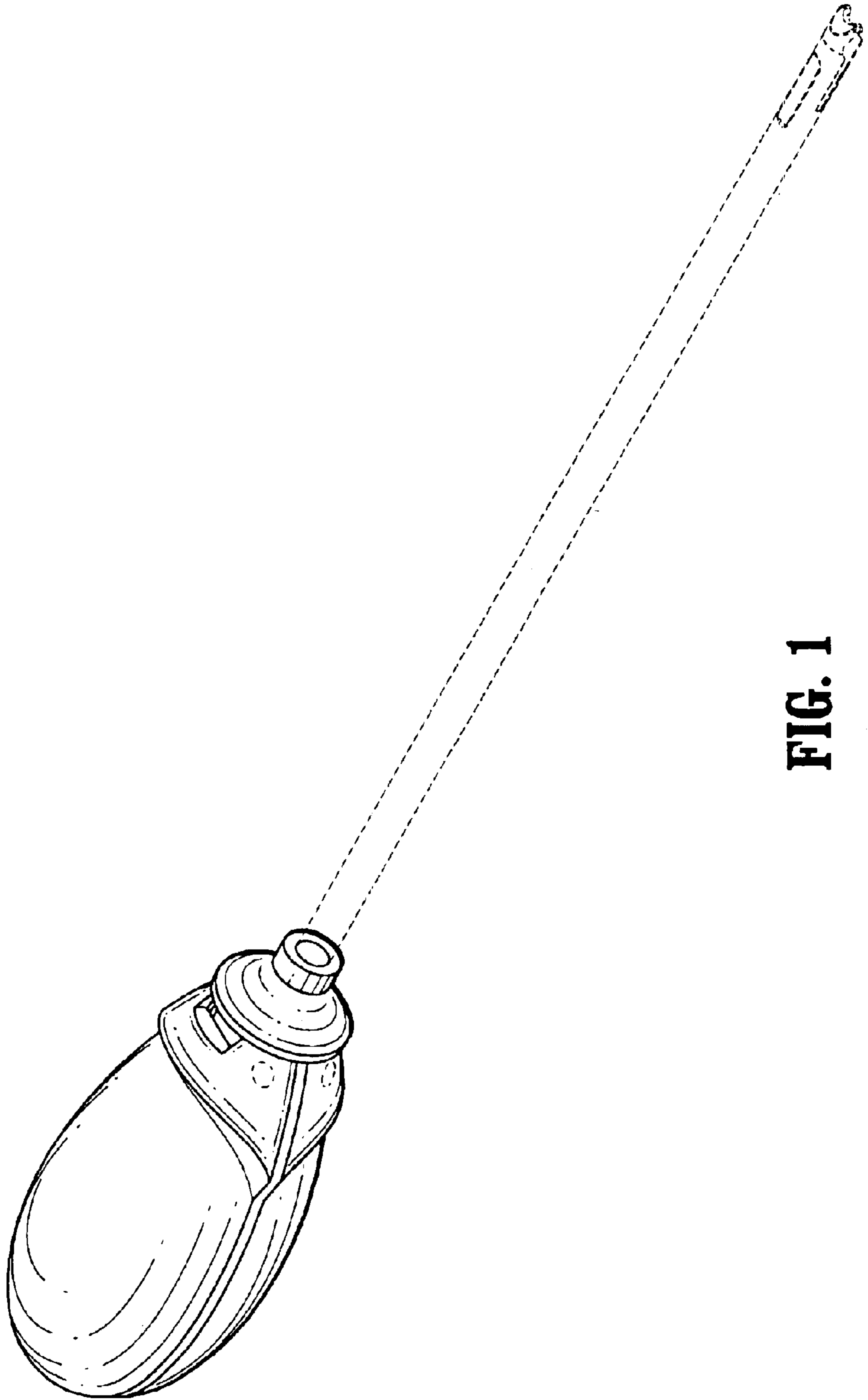

FIG. 1

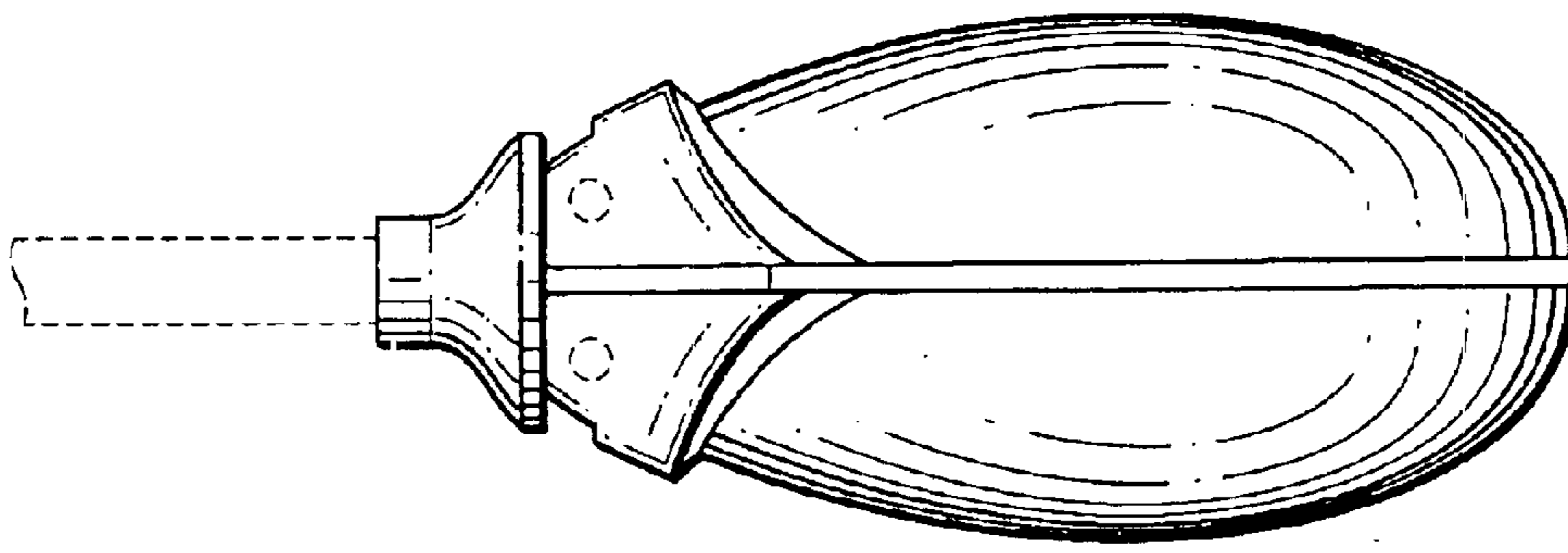

FIG. 2

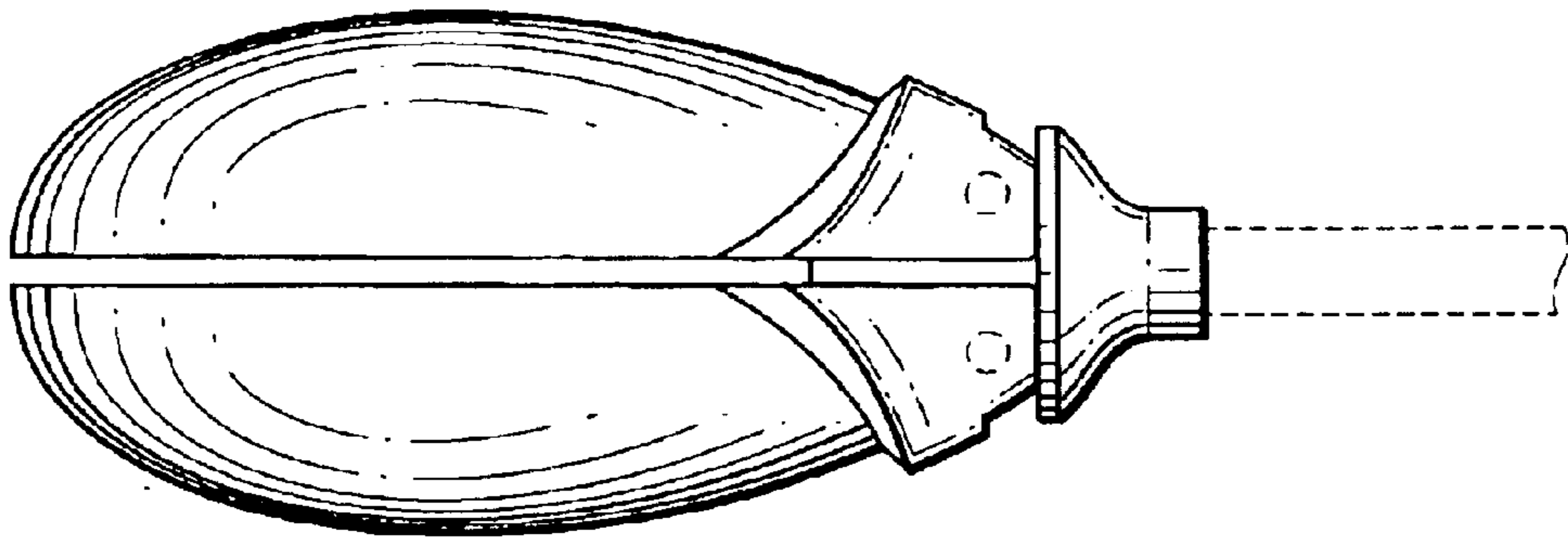

FIG. 3

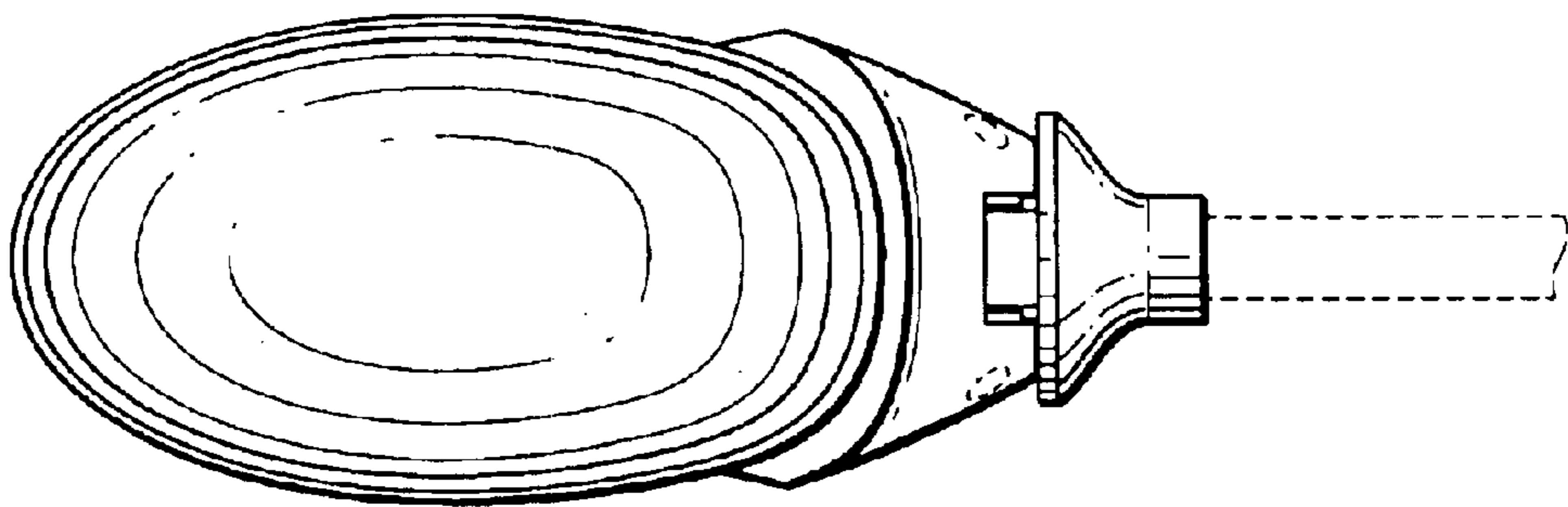

FIG. 4

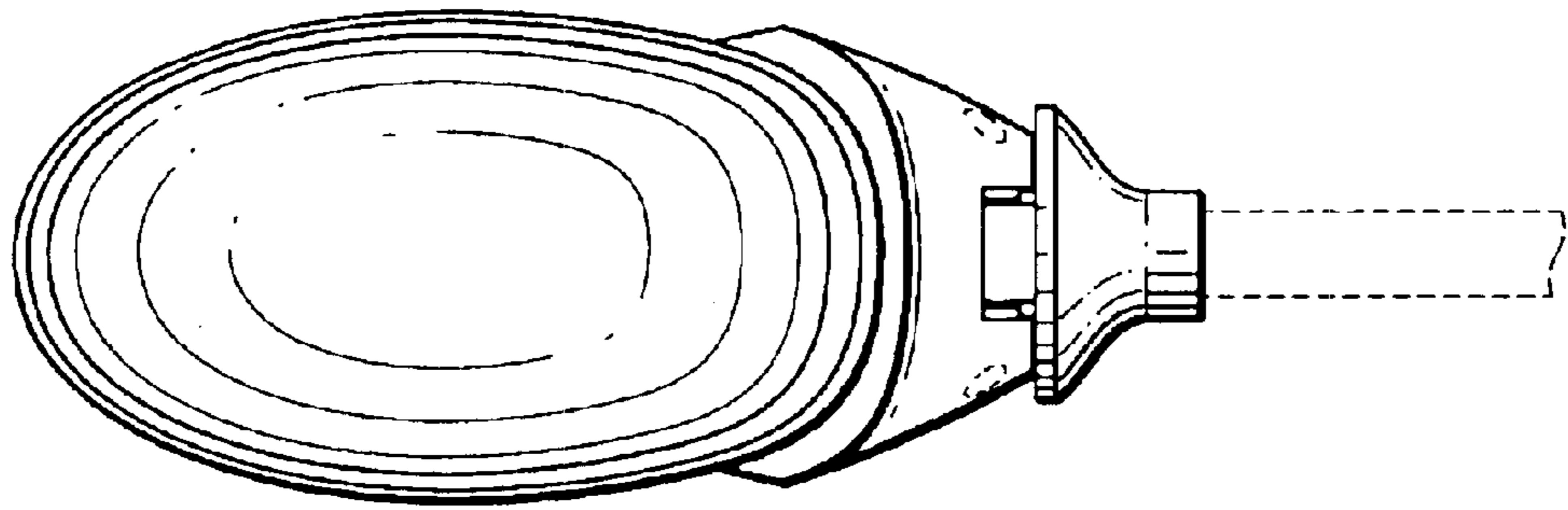

FIG. 5

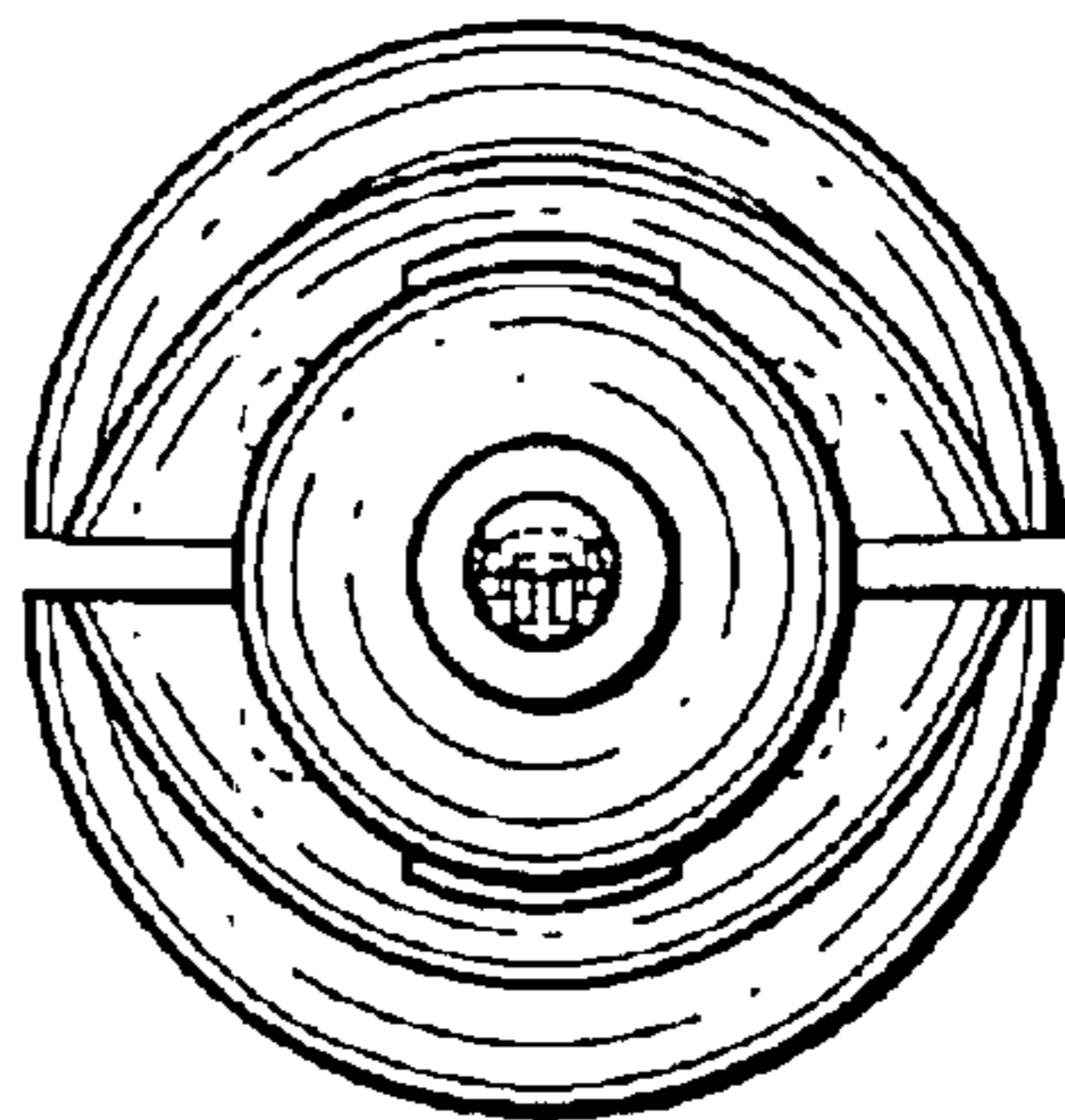

FIG. 6

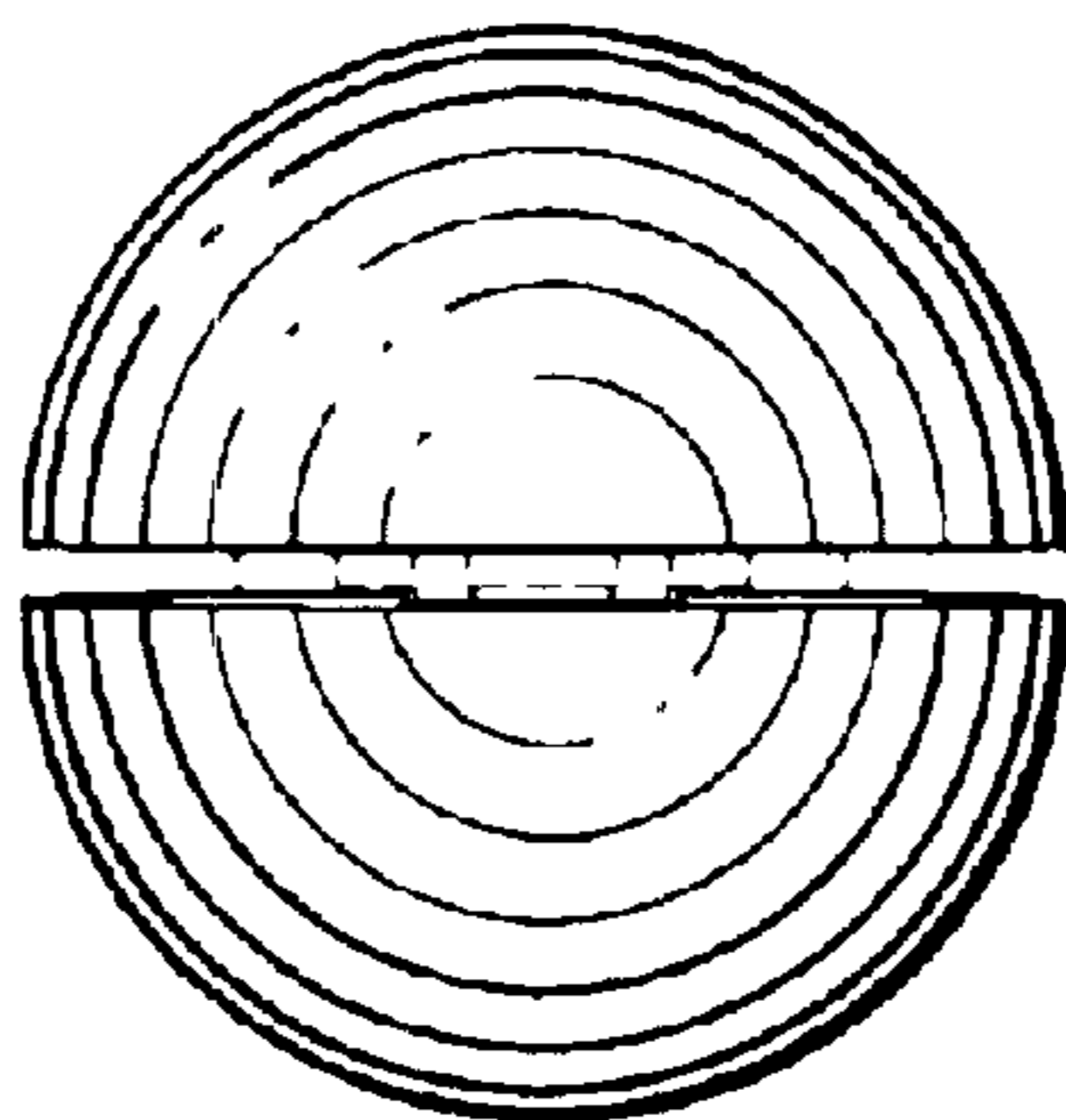

FIG. 7