



US00D490846S

(12) **United States Design Patent**  
**Suzuki et al.**

(10) **Patent No.:** **US D490,846 S**

(45) **Date of Patent:** **\*\* Jun. 1, 2004**

(54) **INK TANK FOR PRINTER**

(75) Inventors: **Toru Suzuki**, Yokohama (JP); **Akira Tsujimoto**, Yokohama (JP); **Kiyomitsu Kudo**, Tokyo (JP); **Satoshi Kudo**, Yokohama (JP)

(73) Assignee: **Canon Kabushiki Kaisha**, Tokyo (JP)

(\*\*) Term: **14 Years**

(21) Appl. No.: **29/190,896**

(22) Filed: **Sep. 30, 2003**

(30) **Foreign Application Priority Data**

Apr. 18, 2003 (JP) ..... 2003-011087

(51) **LOC (7) Cl.** ..... **18-02**

(52) **U.S. Cl.** ..... **D18/56**

(58) **Field of Search** ..... D18/40, 43, 56,  
D18/12; 347/49, 86, 87, 101, 214; 399/110,  
111, 114, 119, 120, 259, 262

(56) **References Cited**

**U.S. PATENT DOCUMENTS**

- D245,761 S \* 9/1977 Alseth et al. .... D18/43
- D298,255 S \* 10/1988 Hirata ..... D18/43
- D298,336 S \* 11/1988 Masaki ..... D18/43
- D308,885 S \* 6/1990 Okayama et al. .... D18/40

- D431,259 S \* 9/2000 Muranaka ..... D18/43
- D442,215 S \* 5/2001 Fujita ..... D18/43
- D461,495 S 8/2002 Nanjo et al. .... D18/56
- D467,267 S 12/2002 Nanjo et al. .... D18/56
- D477,020 S \* 7/2003 Seino ..... D18/56

\* cited by examiner

*Primary Examiner*—Caron D. Veynar

(74) *Attorney, Agent, or Firm*—Fitzpatrick, Cella, Harper & Scinto

(57) **CLAIM**

The ornamental design for an ink tank for printer, as shown and described.

**DESCRIPTION**

FIG. 1 is a front view of an ink tank for printer showing our new design;

FIG. 2 is a rear view thereof;

FIG. 3 is a top plan view thereof;

FIG. 4 is a bottom plan view thereof;

FIG. 5 is a left side view thereof;

FIG. 6 is a right side view thereof; and,

FIG. 7 is a perspective view thereof.

The portions of the article in broken lines are shown for illustrative purposes only and form no part of the claimed design.

**1 Claim, 3 Drawing Sheets**

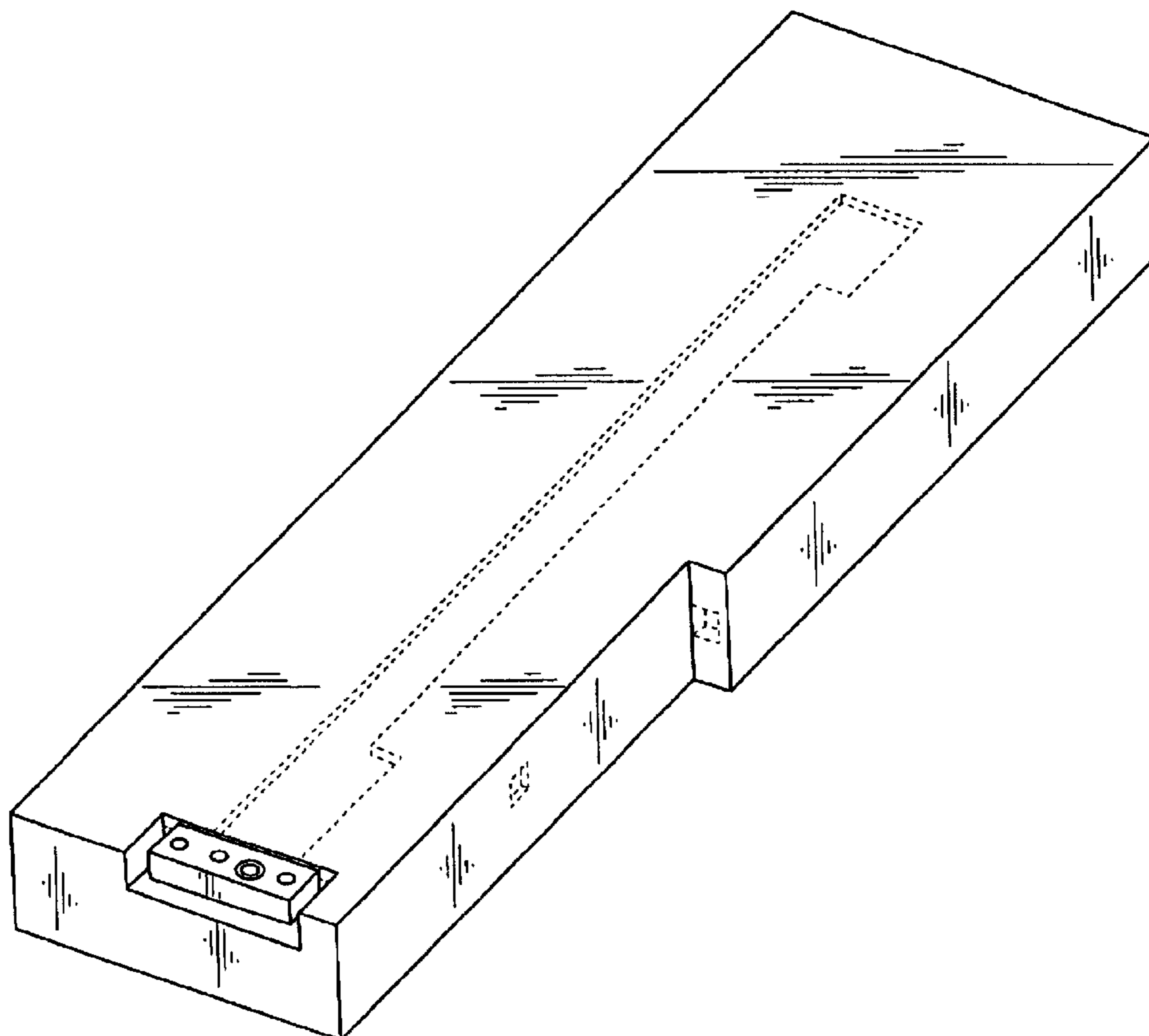

FIG. 1

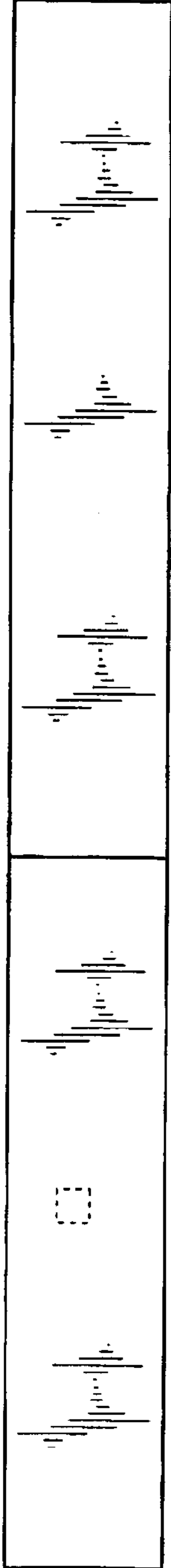

FIG. 2

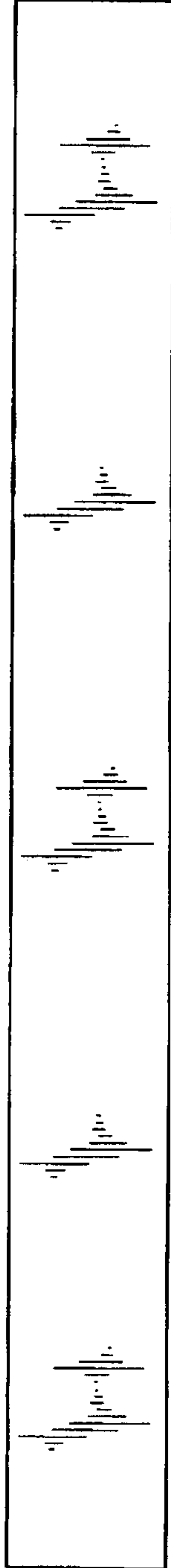
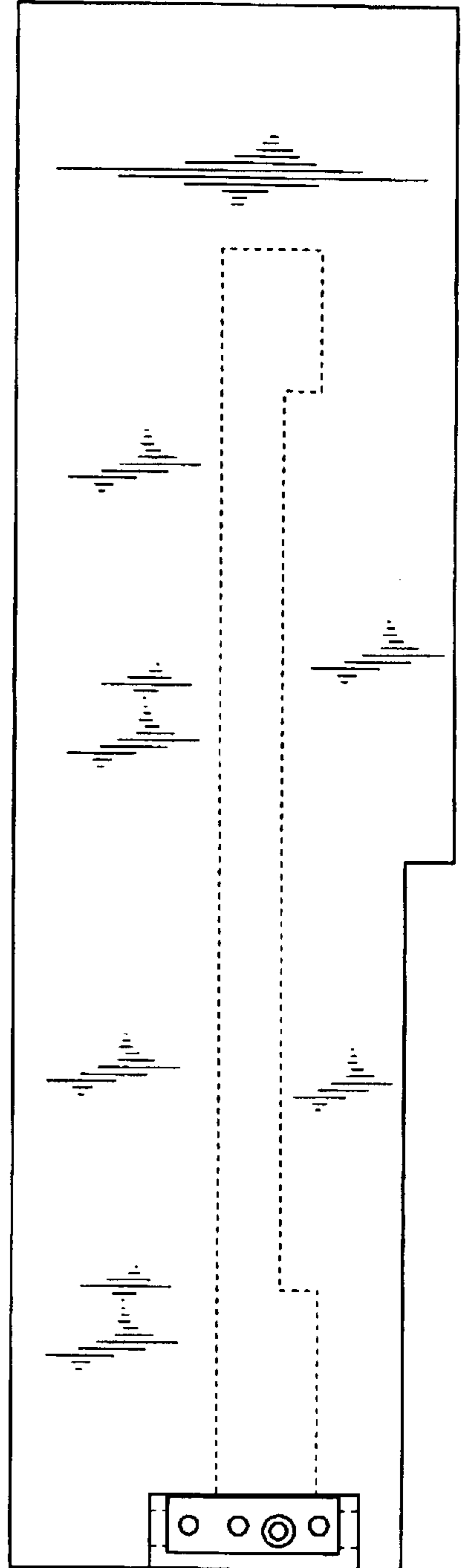
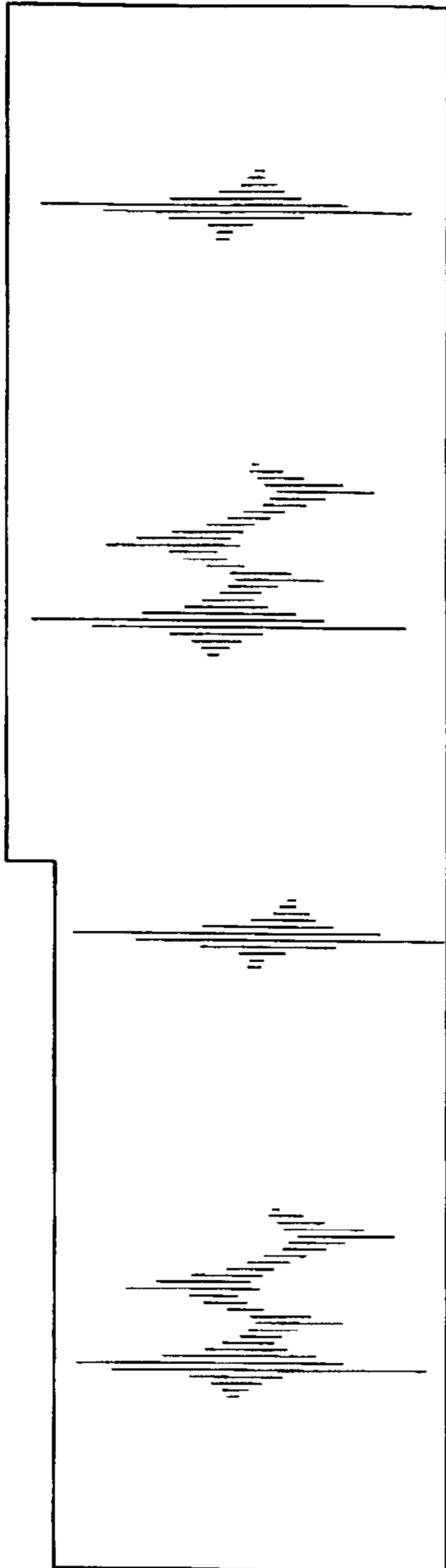

FIG. 3



**FIG. 4**



**FIG. 5**

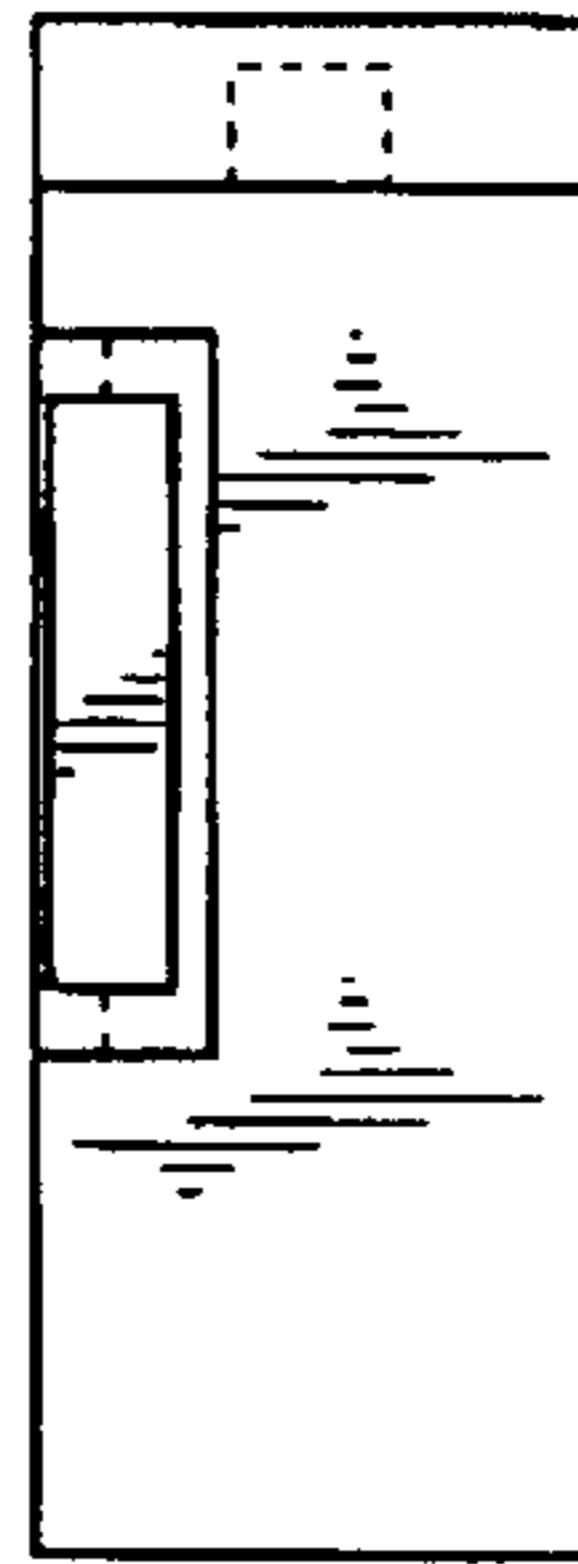

**FIG. 6**

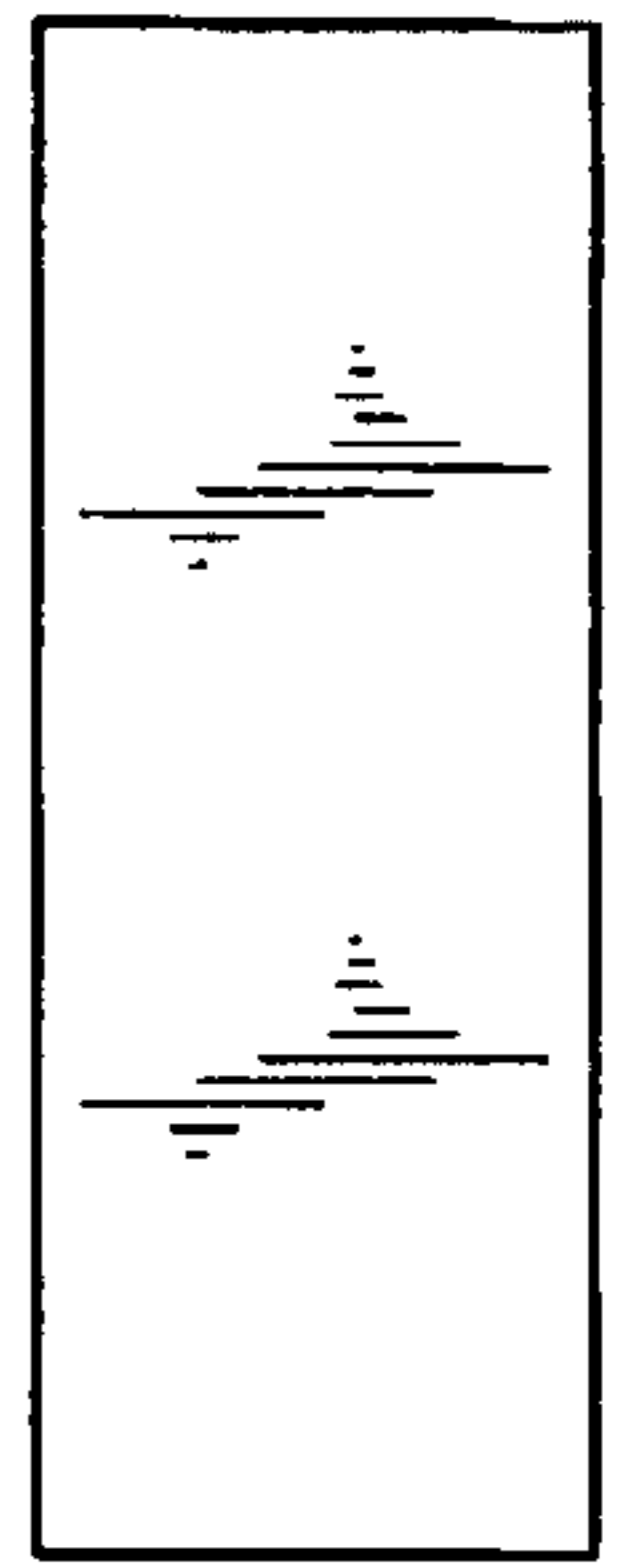

*FIG. 7*

