



US00D490843S

(12) **United States Design Patent**
Minagawa et al.

(10) **Patent No.:** **US D490,843 S**

(45) **Date of Patent:** **** Jun. 1, 2004**

(54) **TONER SUPPLYING CARTRIDGE**

D468,345 S * 1/2003 Tanaka et al. D18/43

(75) Inventors: **Hironori Minagawa**, Moriya (JP);
Tetsuo Isomura, Abiko (JP); **Tetsuro**
Awaya, Tokyo (JP)

(73) Assignee: **Canon Kabushiki Kaisha**, Tokyo (JP)

(**) Term: **14 Years**

(21) Appl. No.: **29/188,290**

(22) Filed: **Aug. 18, 2003**

(30) **Foreign Application Priority Data**

Feb. 24, 2003 (JP) 2003-004405

(51) **LOC (7) Cl.** **16-03**

(52) **U.S. Cl.** **D18/43**

(58) **Field of Search** D18/40, 43, 56;
347/49, 86, 87, 101, 214; 399/110, 111,
114, 119, 120, 259, 262

(56) **References Cited**

U.S. PATENT DOCUMENTS

D277,289 S * 1/1985 Sabin D18/43

D366,277 S * 1/1996 Kawamura D18/43

OTHER PUBLICATIONS

U.S. patent application Ser. No. 29/188,289, Minagawa et al., filed Aug. 18, 2003.

* cited by examiner

Primary Examiner—Caron D. Veynar

(74) *Attorney, Agent, or Firm*—Fitzpatrick, Cella, Harper & Scinto

(57) **CLAIM**

The ornamental design for a toner supplying cartridge, as shown and described.

DESCRIPTION

FIG. 1 is a front view of a toner supplying cartridge showing our new design;

FIG. 2 is a rear view thereof;

FIG. 3 is a top plan view thereof;

FIG. 4 is a bottom plan view thereof;

FIG. 5 is a left side view thereof;

FIG. 6 is a right side view thereof; and,

FIG. 7 is a perspective view thereof.

1 Claim, 4 Drawing Sheets

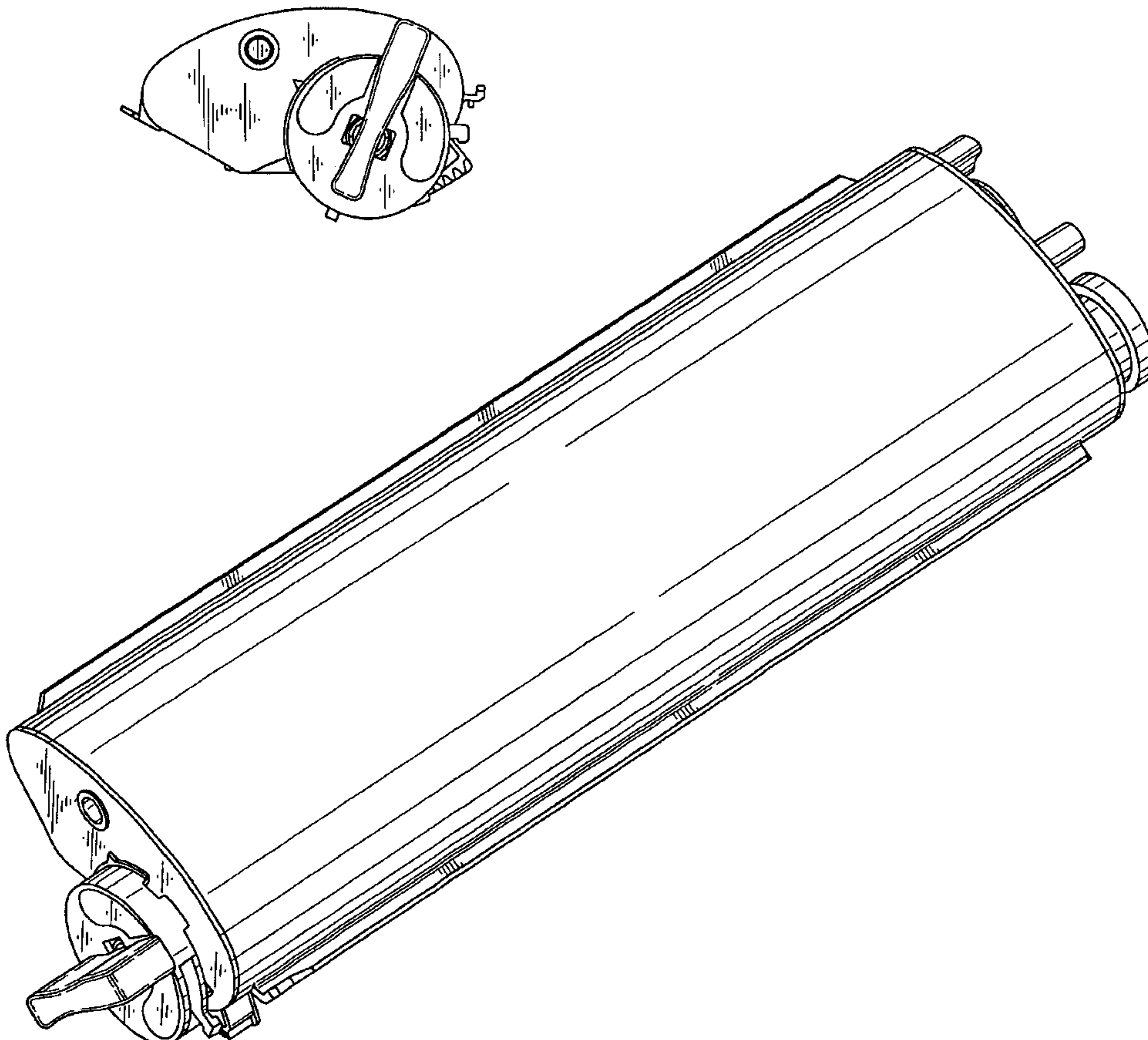

FIG. 1

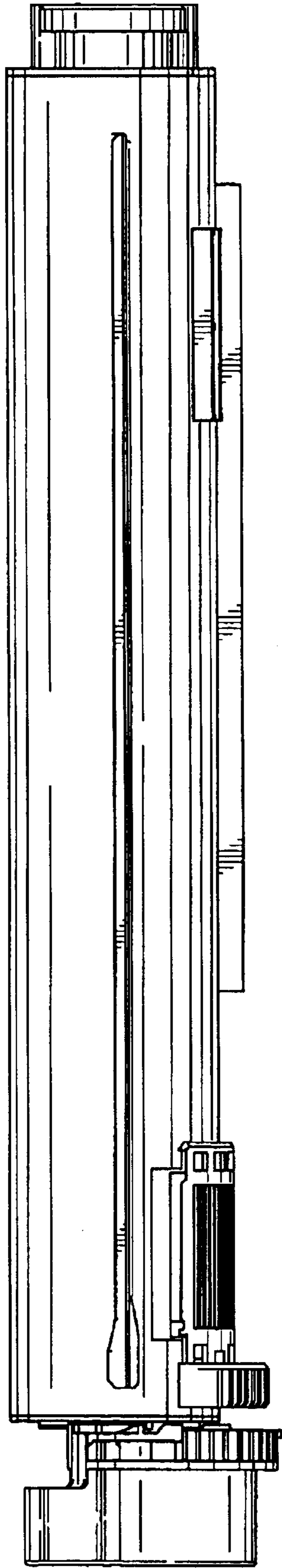

FIG. 2

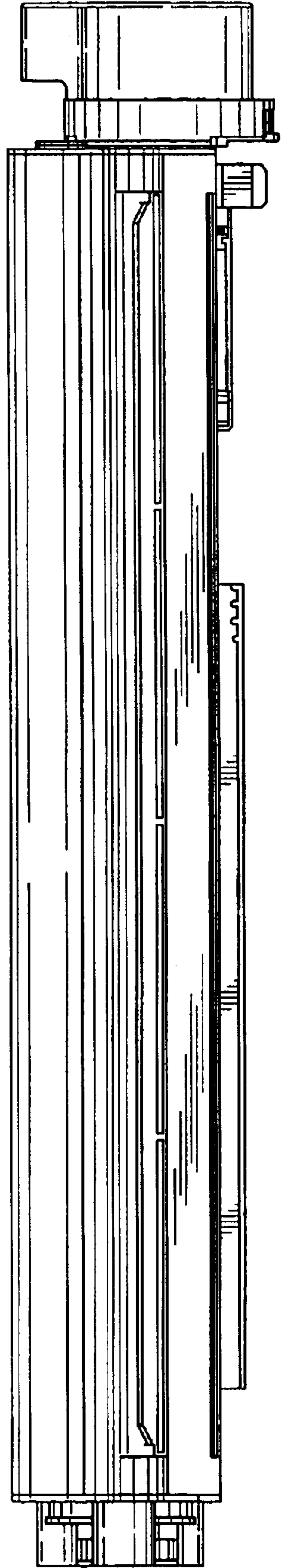

FIG. 3

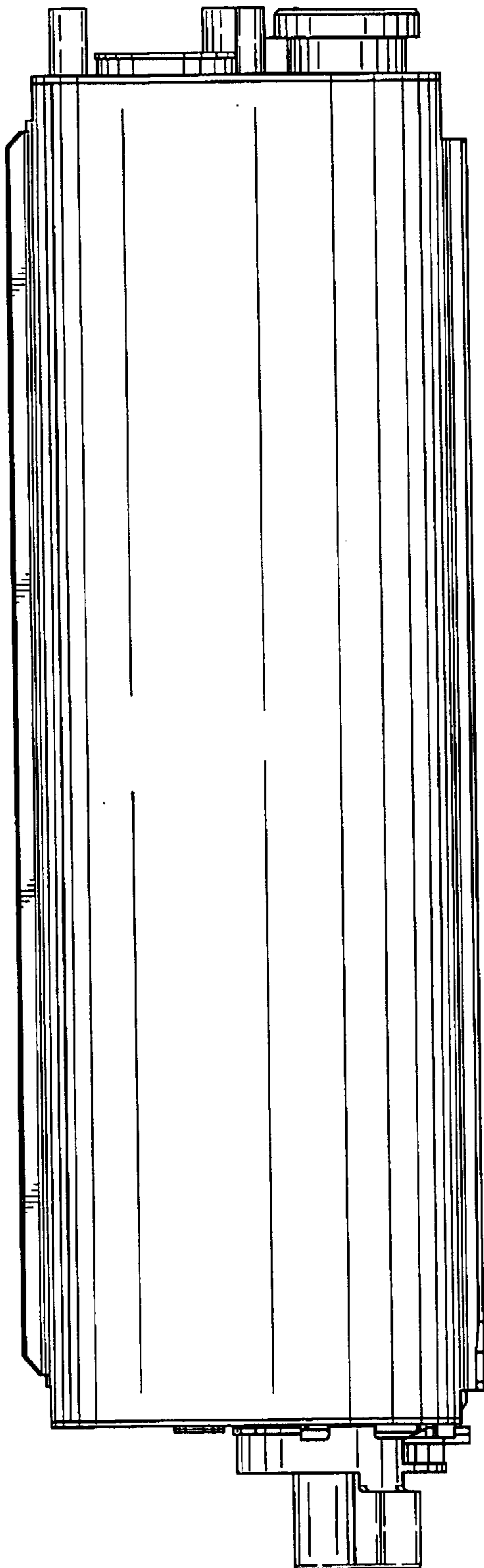

FIG. 4

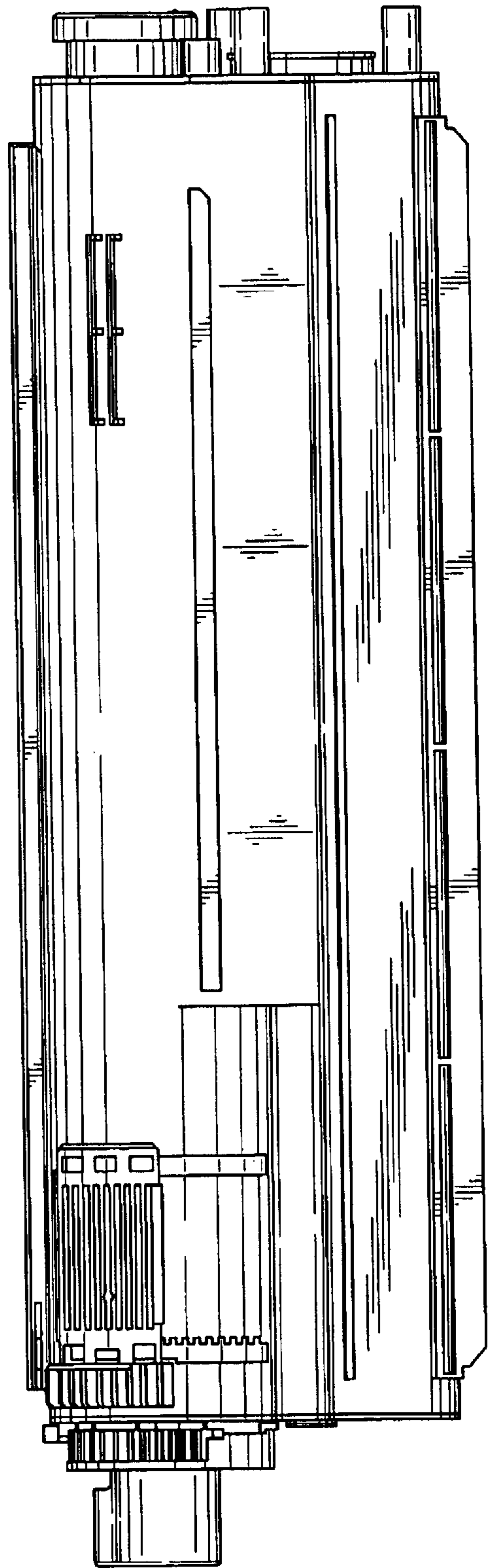

FIG. 5

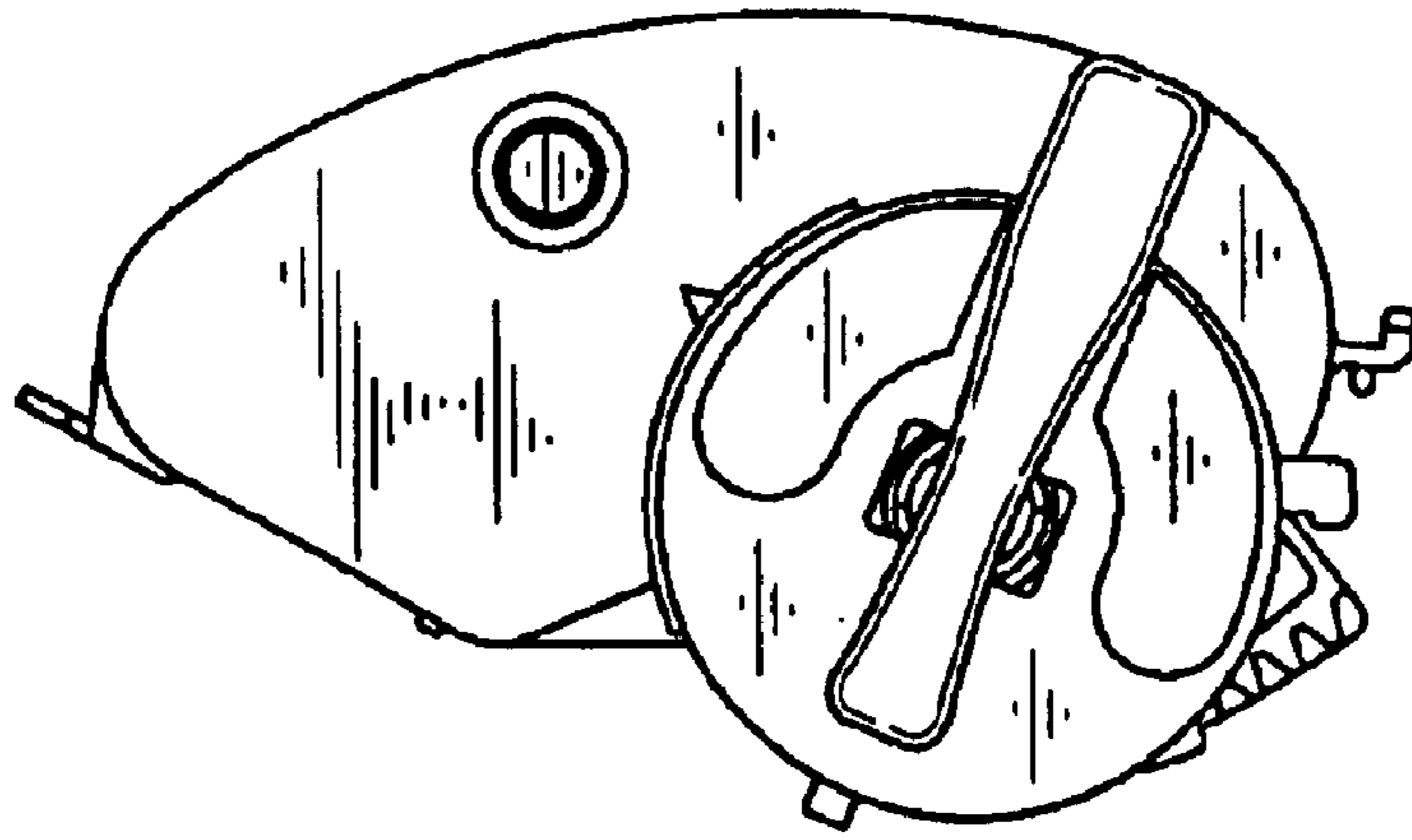
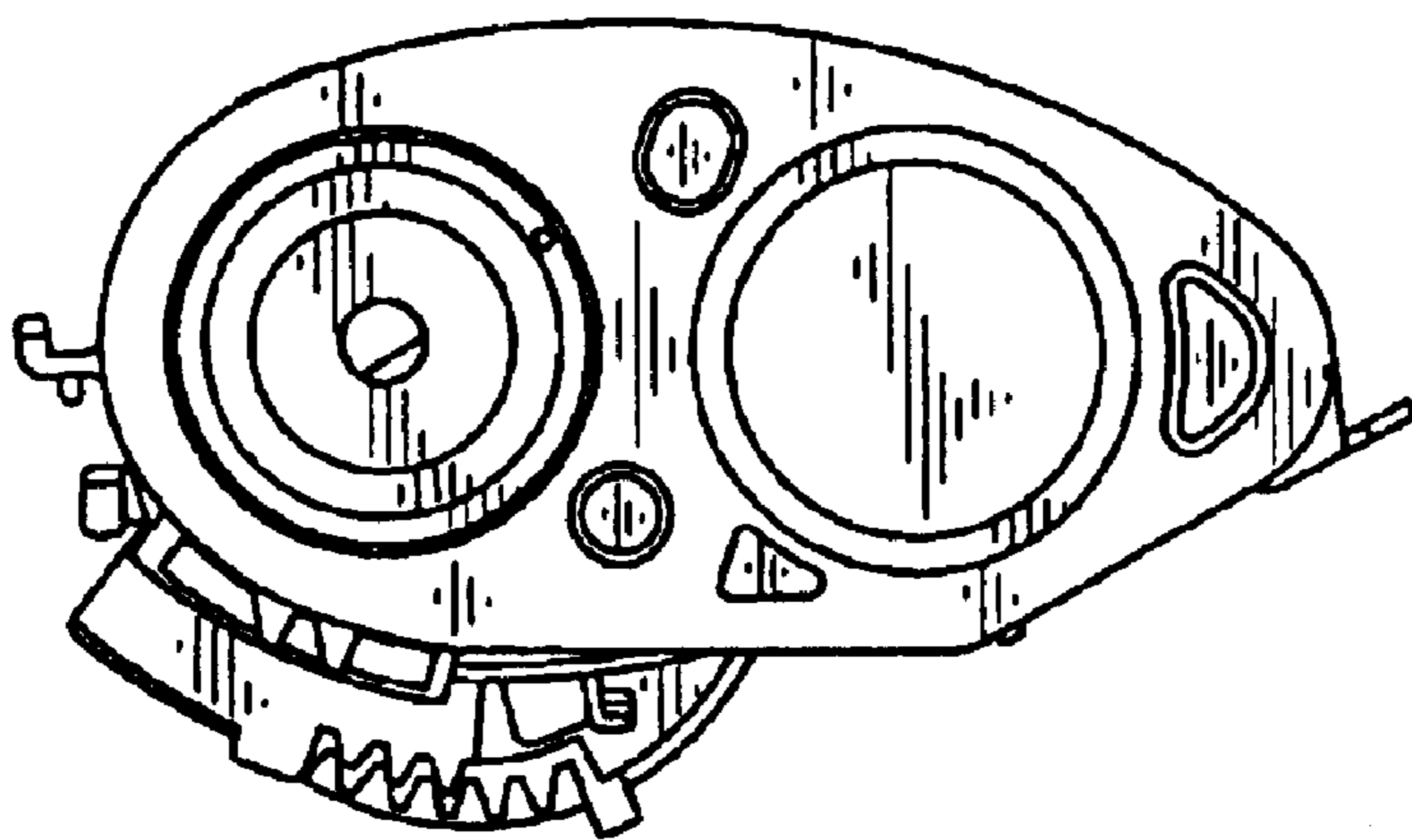

FIG. 6



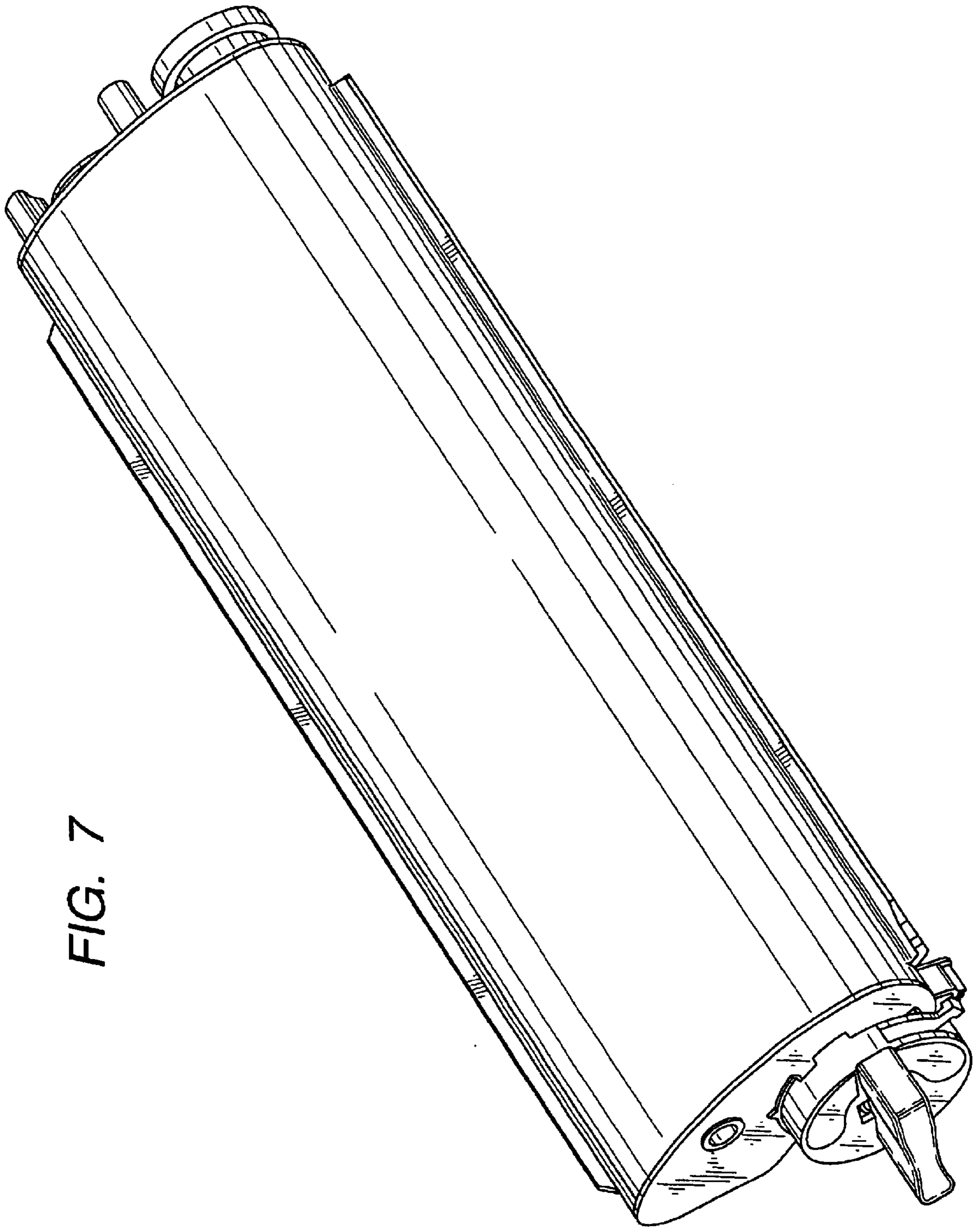

FIG. 7