



US00D490814S

(12) **United States Design Patent**
Kim

(10) **Patent No.:** **US D490,814 S**

(45) **Date of Patent:** **** Jun. 1, 2004**

(54) **USB BASED PORTABLE STORAGE DEVICE**

(75) Inventor: **Eung-Chan Kim**, Dongdaemoon Gu (KR)

(73) Assignee: **Jungsoft Co., Ltd.**, Sungham-shi (KR)

(**) Term: **14 Years**

(21) Appl. No.: **29/164,653**

(22) Filed: **Jul. 30, 2002**

(30) **Foreign Application Priority Data**

Jun. 24, 2002 (KR) 2002-18320

(51) **LOC (7) Cl.** **14-02**

(52) **U.S. Cl.** **D14/435; D14/242; D14/433**

(58) **Field of Search** **D14/432-438, D14/240, 242, 256; 711/103, 154**

(56) **References Cited**

U.S. PATENT DOCUMENTS

- D261,644 S * 11/1981 McKinsey et al. D14/435
- D285,569 S * 9/1986 Reitz et al. D14/438
- D286,053 S * 10/1986 McDaniel et al. D14/438
- 2002/0147882 A1 * 10/2002 Rua et al. 711/103

FOREIGN PATENT DOCUMENTS

EP 1310908 A2 * 5/2003

* cited by examiner

Primary Examiner—Kay H. Chin

(74) *Attorney, Agent, or Firm*—Fleshner & Kim, LLP

(57) **CLAIM**

The ornamental design for a USB based portable storage device, as shown and described.

DESCRIPTION

FIG. 1 is a front elevation view a USB based portable storage device showing my new design;

FIG. 2 is a rear elevation view thereof;

FIG. 3 is a left side elevation view thereof;

FIG. 4 is a right side elevation view thereof;

FIG. 5 is a top view thereof;

FIG. 6 is a bottom view thereof;

FIG. 7 is a perspective view thereof;

FIG. 8 is an exploded front elevation view thereof showing how a cap of the USB based portable storage device can be removed; and,

FIG. 9 is a perspective view thereof showing how various carrying devices can be mounted on the USB based portable storage device.

1 Claim, 4 Drawing Sheets

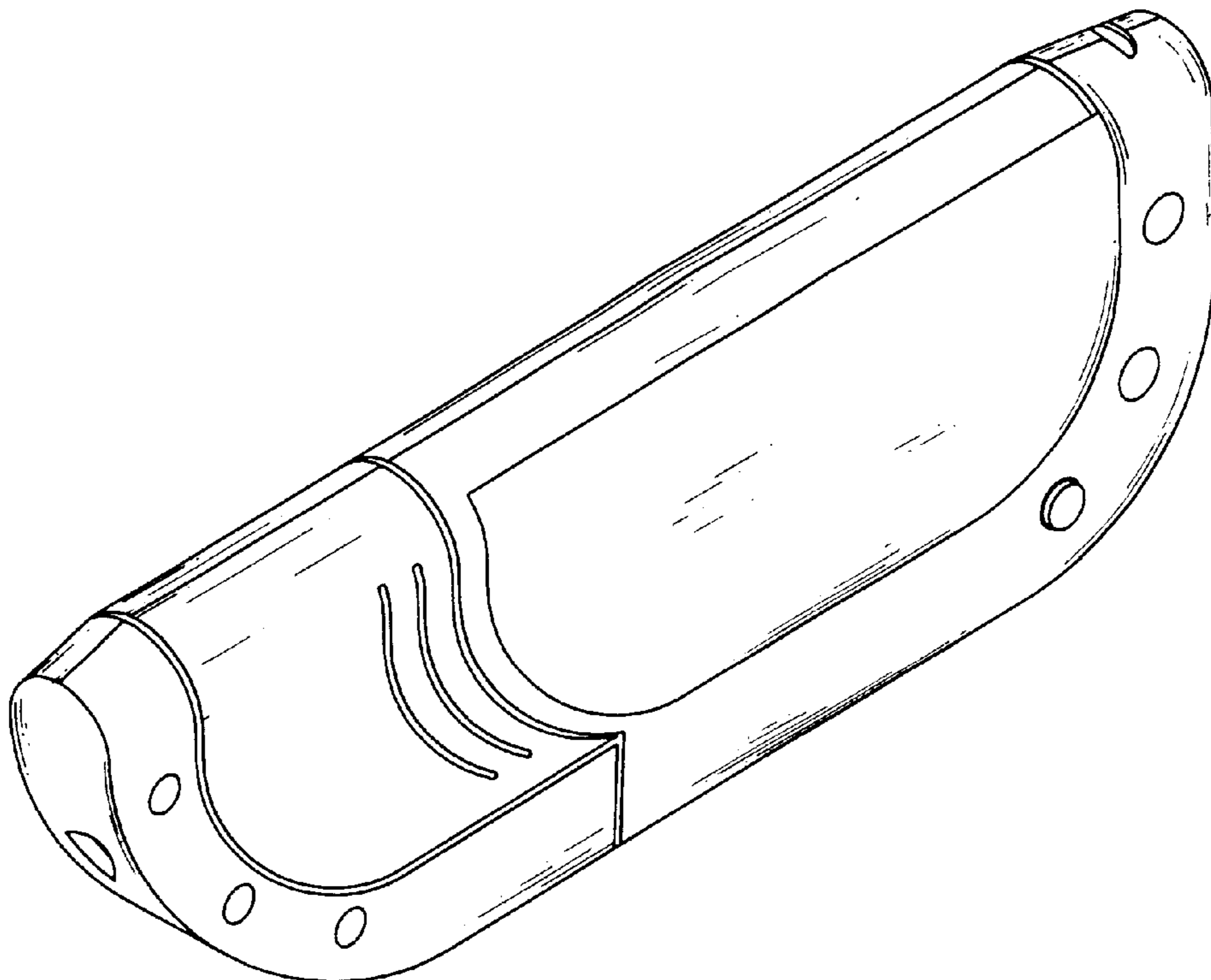

FIG. 1

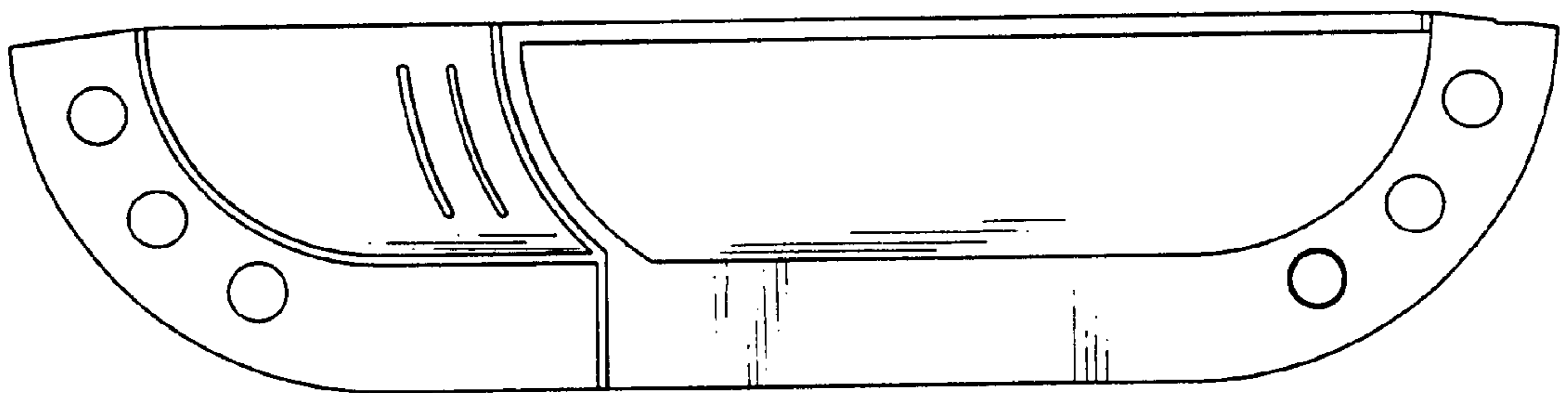

FIG. 2

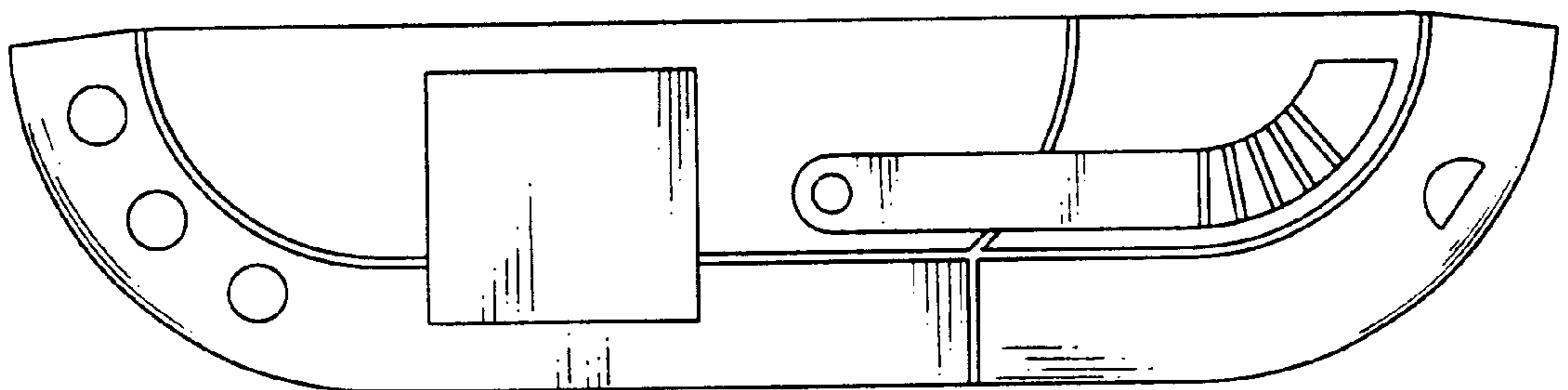

FIG. 3

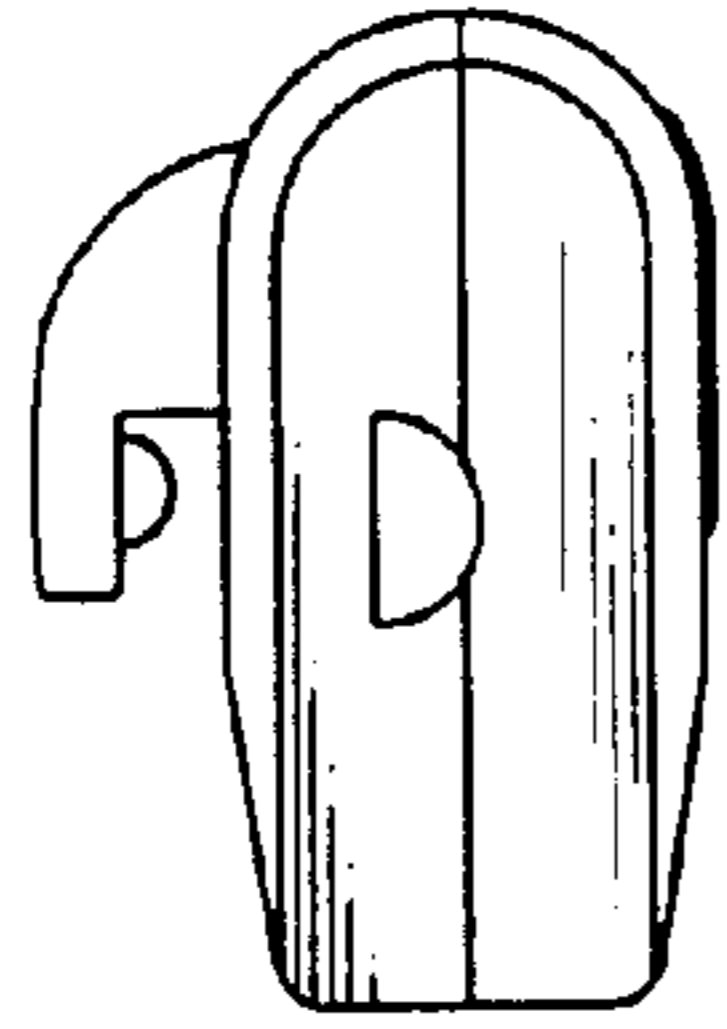

FIG. 4

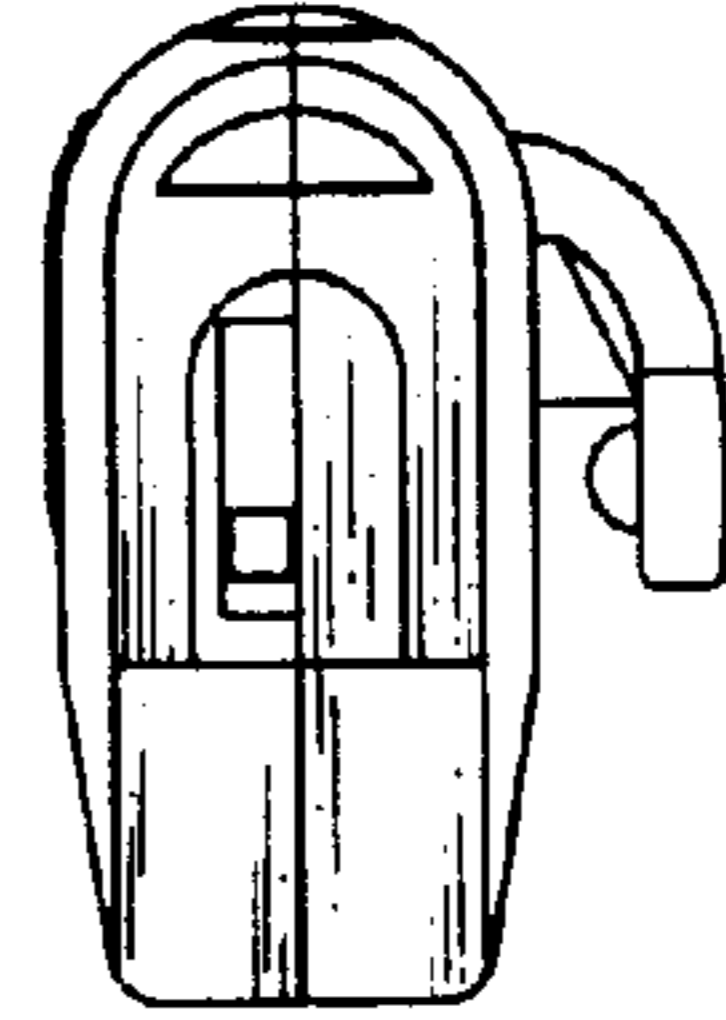

FIG. 5

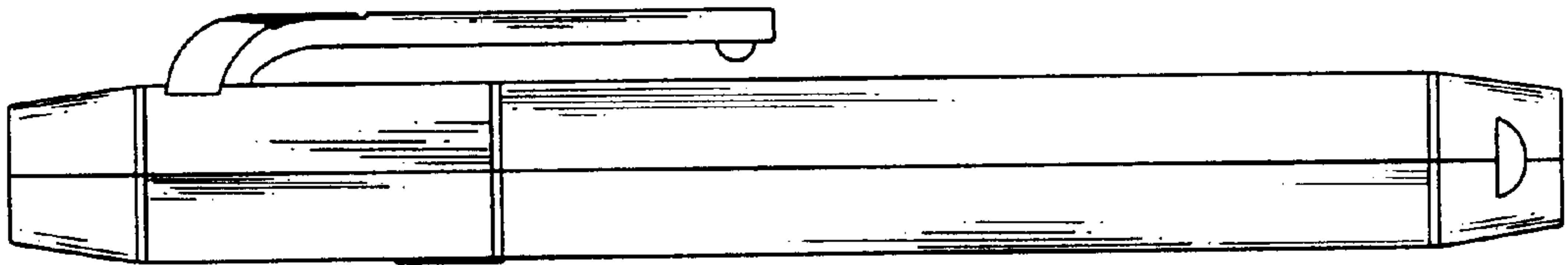

FIG. 6

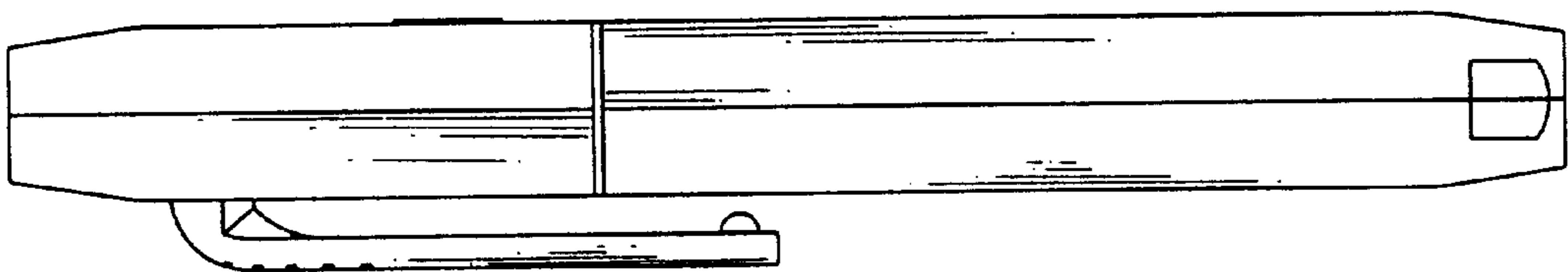

FIG. 7

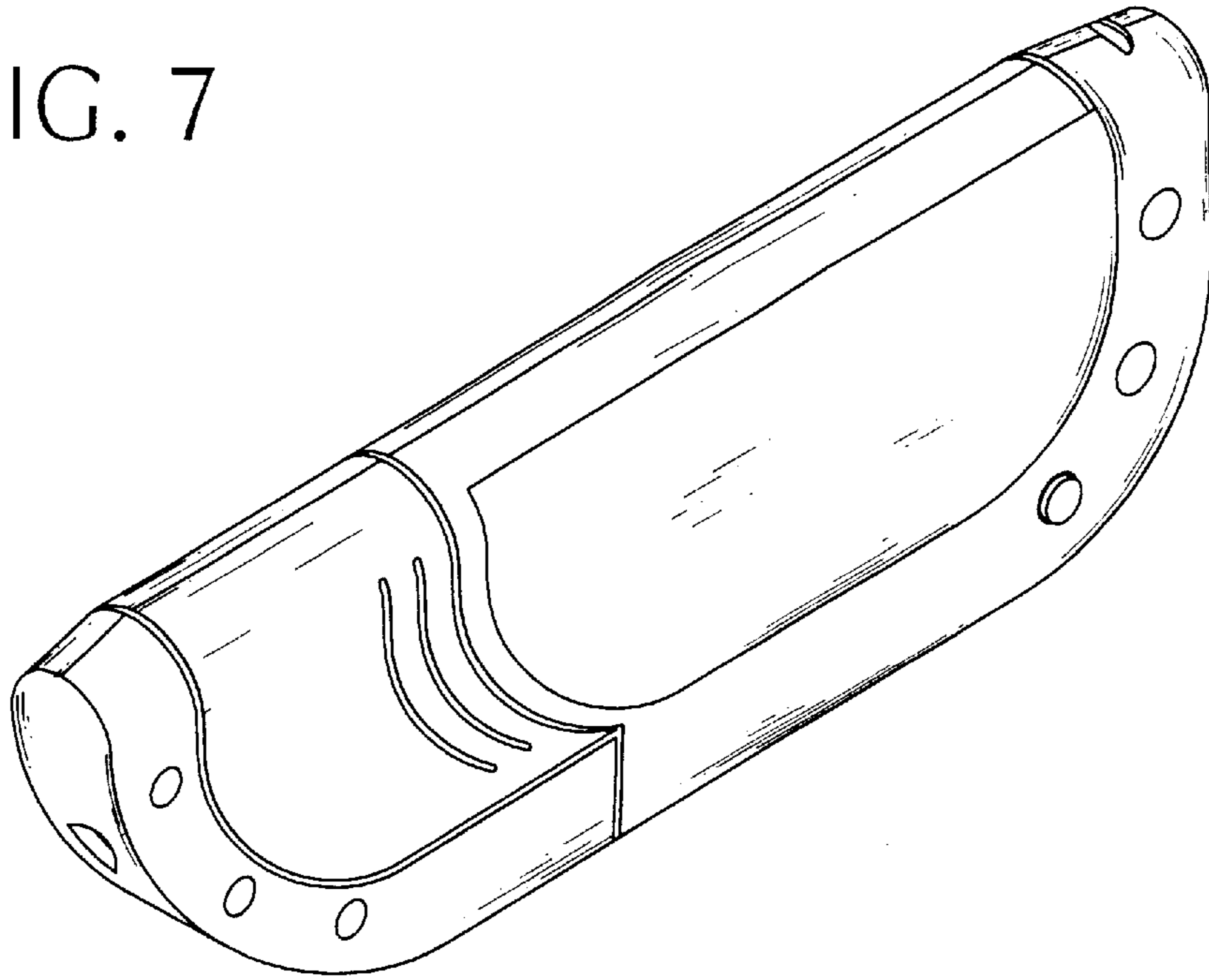

FIG. 8

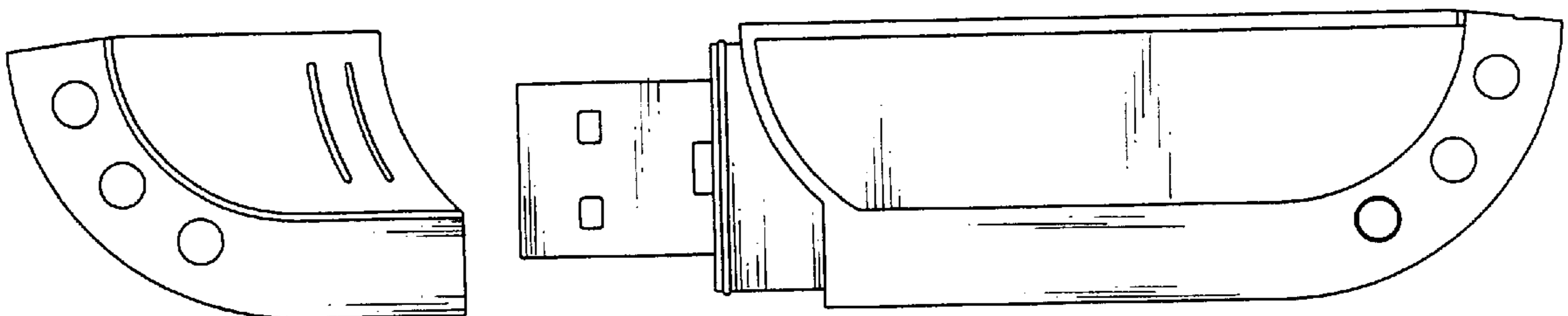

FIG. 9

