



US00D490795S

(12) **United States Design Patent**  
**Watanabe et al.**

(10) **Patent No.:** **US D490,795 S**

(45) **Date of Patent:** **\*\* Jun. 1, 2004**

(54) **TELEPHONE SET**

(75) Inventors: **Hideo Watanabe**, Kanagawa (JP);  
**Akira Nakajima**, Kanagawa (JP);  
**Satoshi Yonai**, Kanagawa (JP)

(73) Assignee: **Matsushita Electric Industrial Co., Ltd.**

(\*\*) Term: **14 Years**

(21) Appl. No.: **29/171,686**

(22) Filed: **Nov. 26, 2002**

(30) **Foreign Application Priority Data**

Sep. 13, 2002 (JP) ..... 2002-025011

(51) **LOC (7) Cl.** ..... **14-03**

(52) **U.S. Cl.** ..... **D14/151**

(58) **Field of Search** ..... D14/149-151,  
D14/143, 144, 241, 130, 329, 330, 243;  
379/202, 420.01, 420.02, 420.03, 433.01,  
433.02, 433.03, 434, 436

(56) **References Cited**

**U.S. PATENT DOCUMENTS**

D282,066 S \* 1/1986 Menei et al. .... D14/151

D303,386 S \* 9/1989 Iino ..... D14/142  
D342,252 S \* 12/1993 Akatsu et al. .... D14/151  
D389,144 S \* 1/1998 Hua ..... D14/151  
D426,535 S \* 6/2000 Zeitman ..... D14/151

**FOREIGN PATENT DOCUMENTS**

JP D1110465 6/2001

\* cited by examiner

*Primary Examiner*—Janice E. Seeger

(74) *Attorney, Agent, or Firm*—Brinks Hofer Gilson & Lione

(57) **CLAIM**

The ornamental design for a telephone set, as shown and described.

**DESCRIPTION**

FIG. 1 is a top perspective view of a telephone set of the present invention;  
FIG. 2 is a front view thereof;  
FIG. 3 is a rear view thereof;  
FIG. 4 is a first side view thereof;  
FIG. 5 is a top view thereof;  
FIG. 6 is a second side view thereof; and,  
FIG. 7 is a bottom rear view thereof.

**1 Claim, 3 Drawing Sheets**

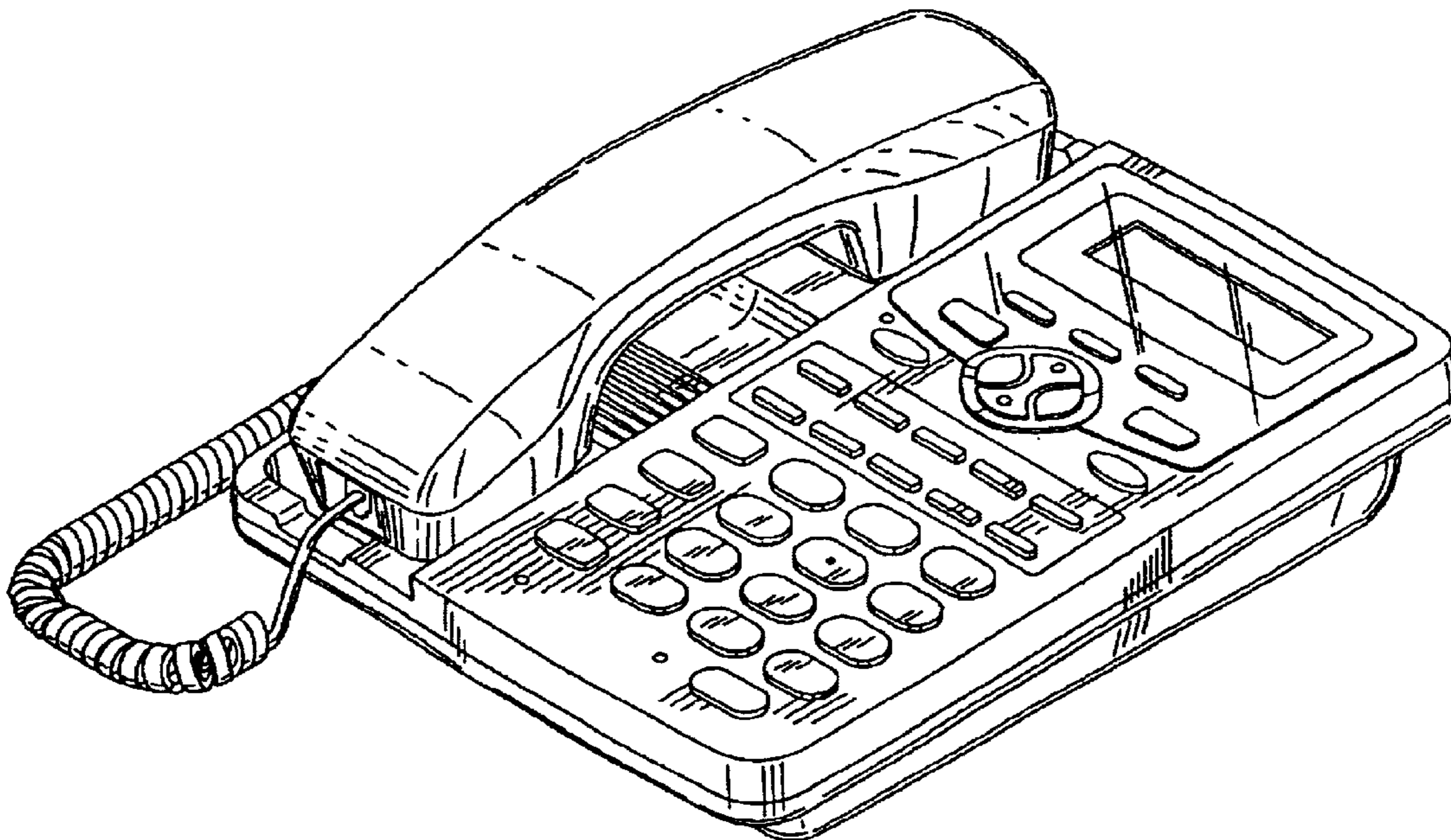

FIG 1

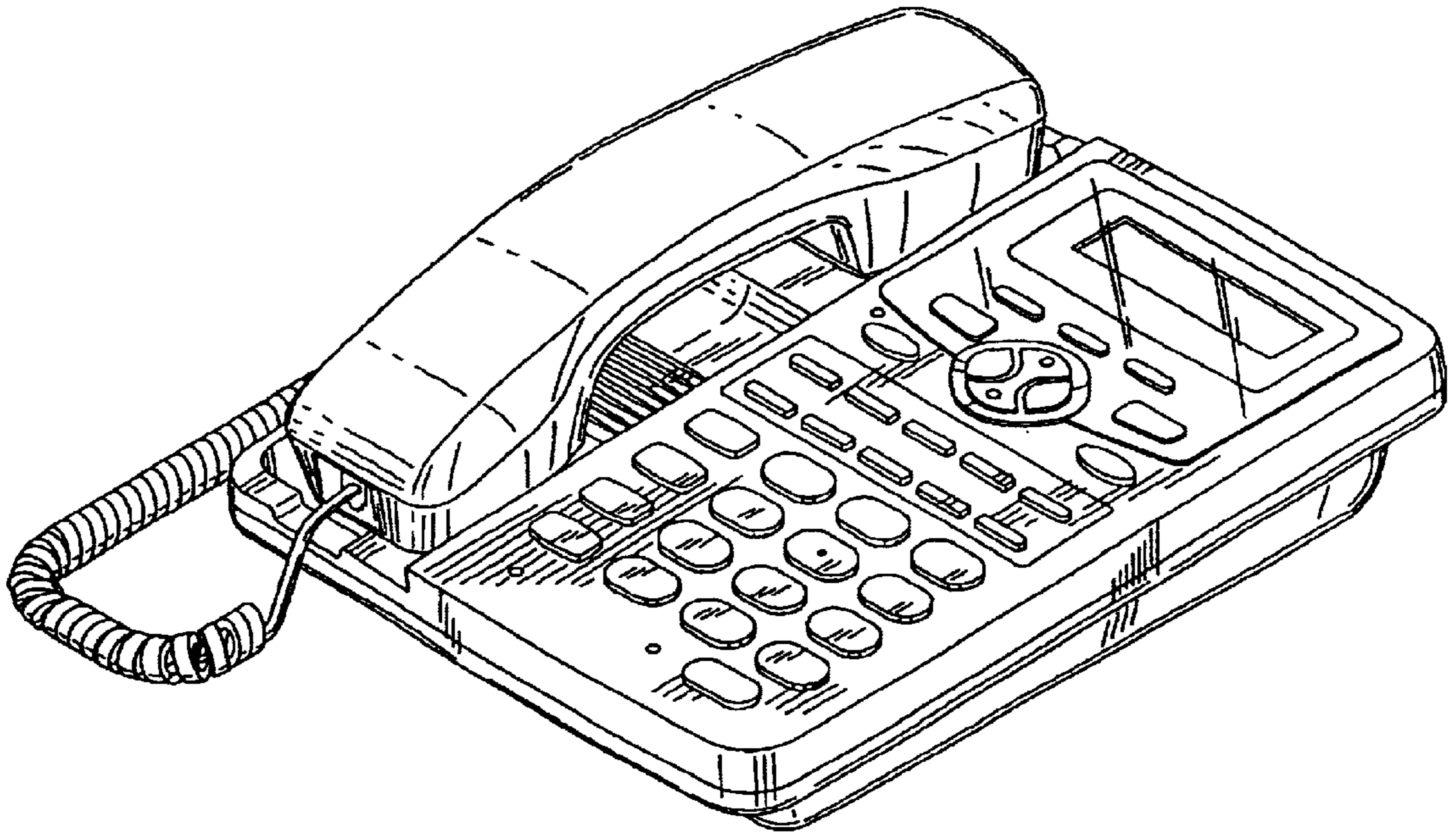

FIG 2

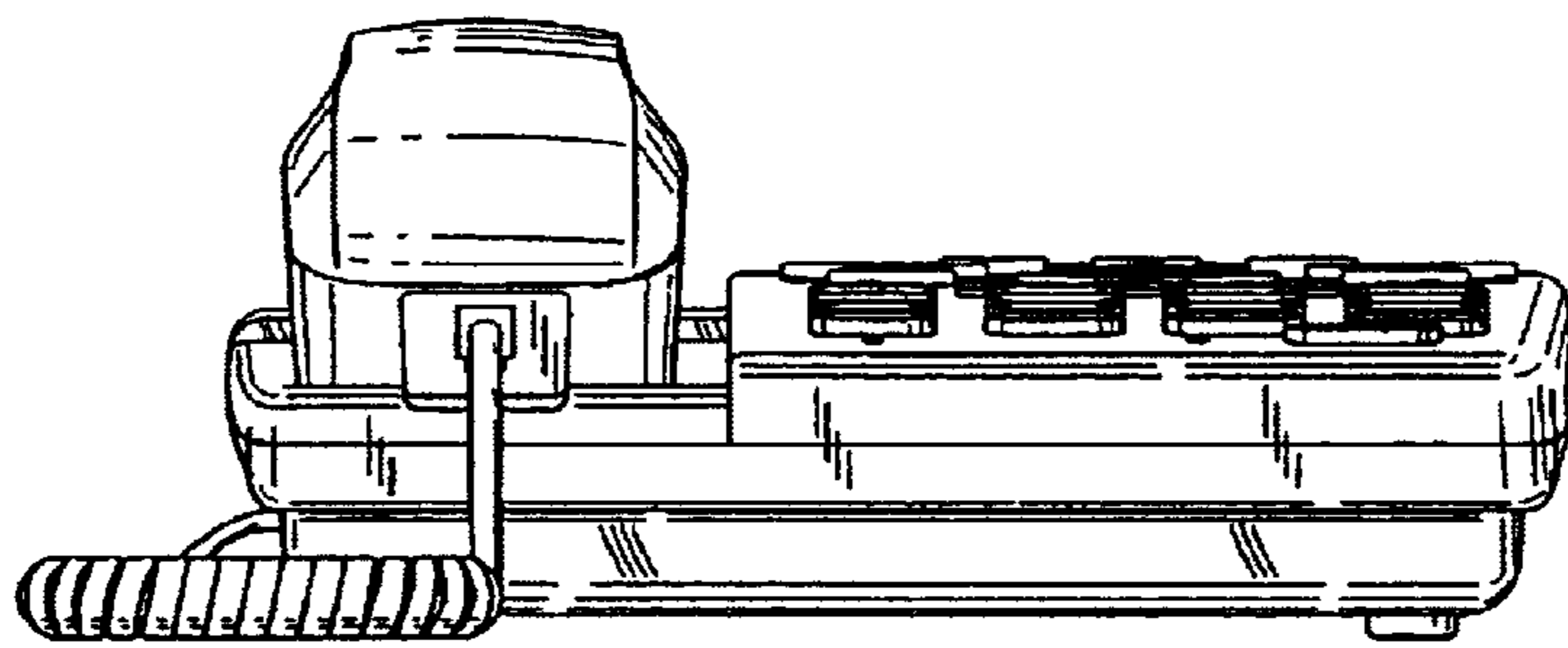

FIG 3

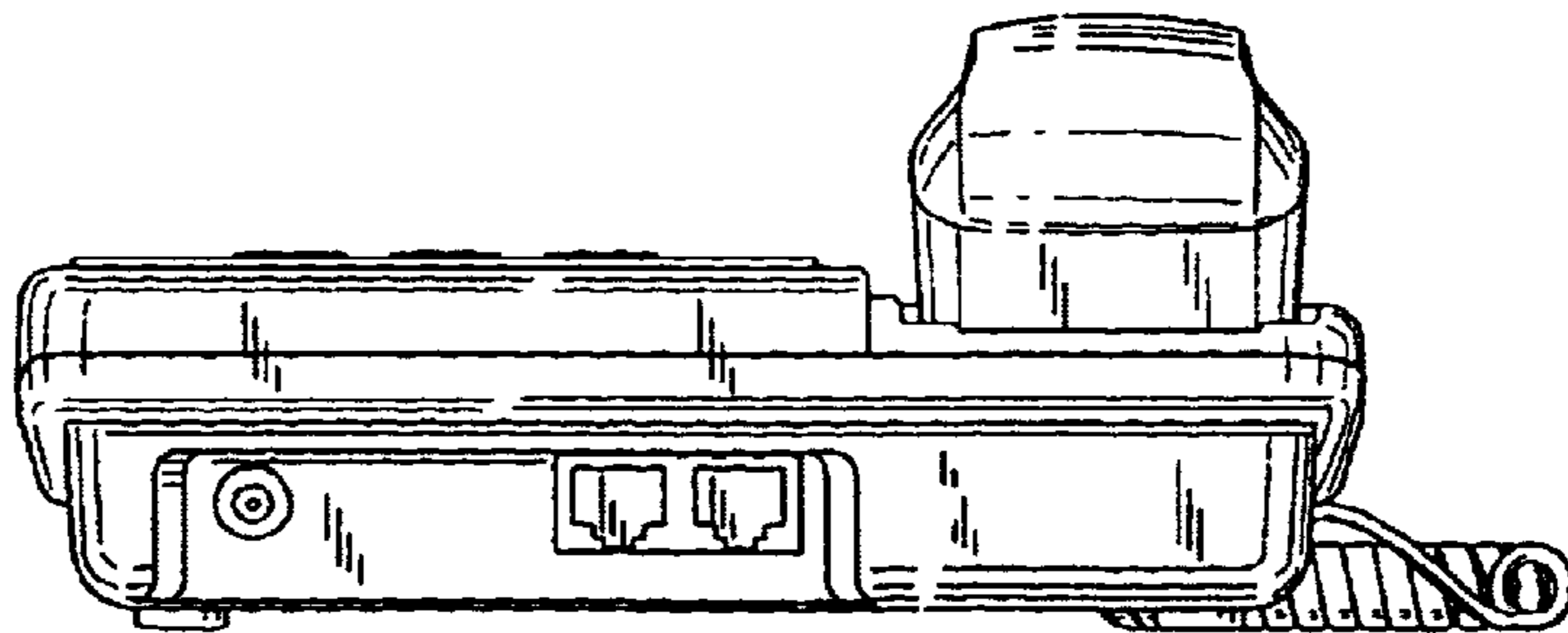

FIG 4

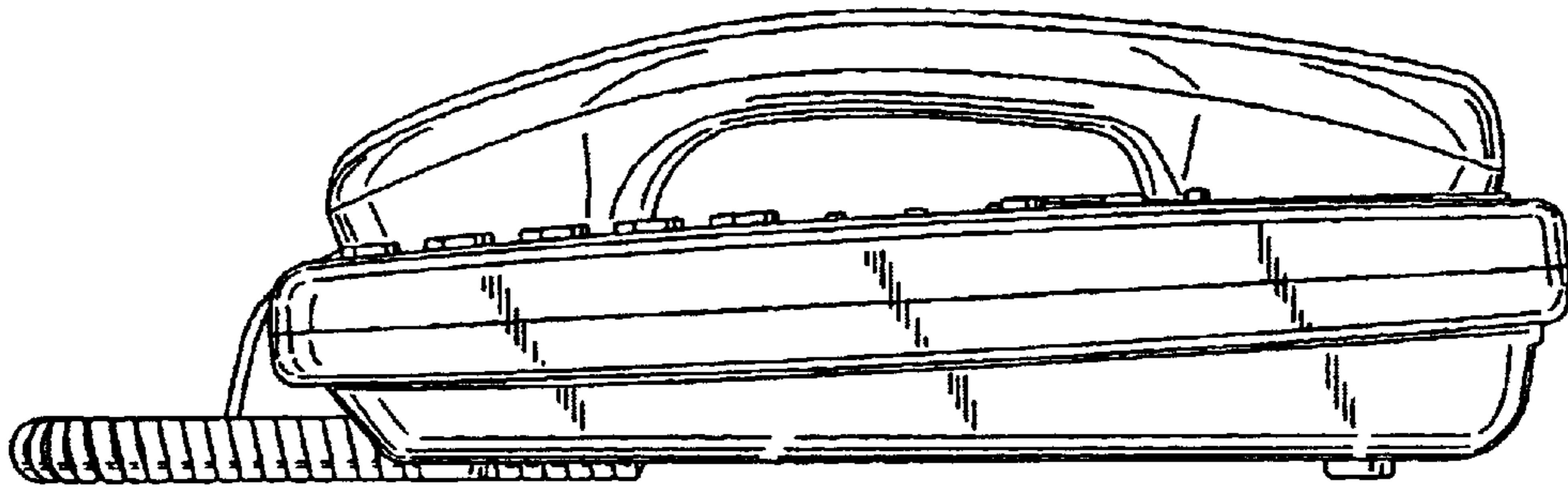

FIG 5

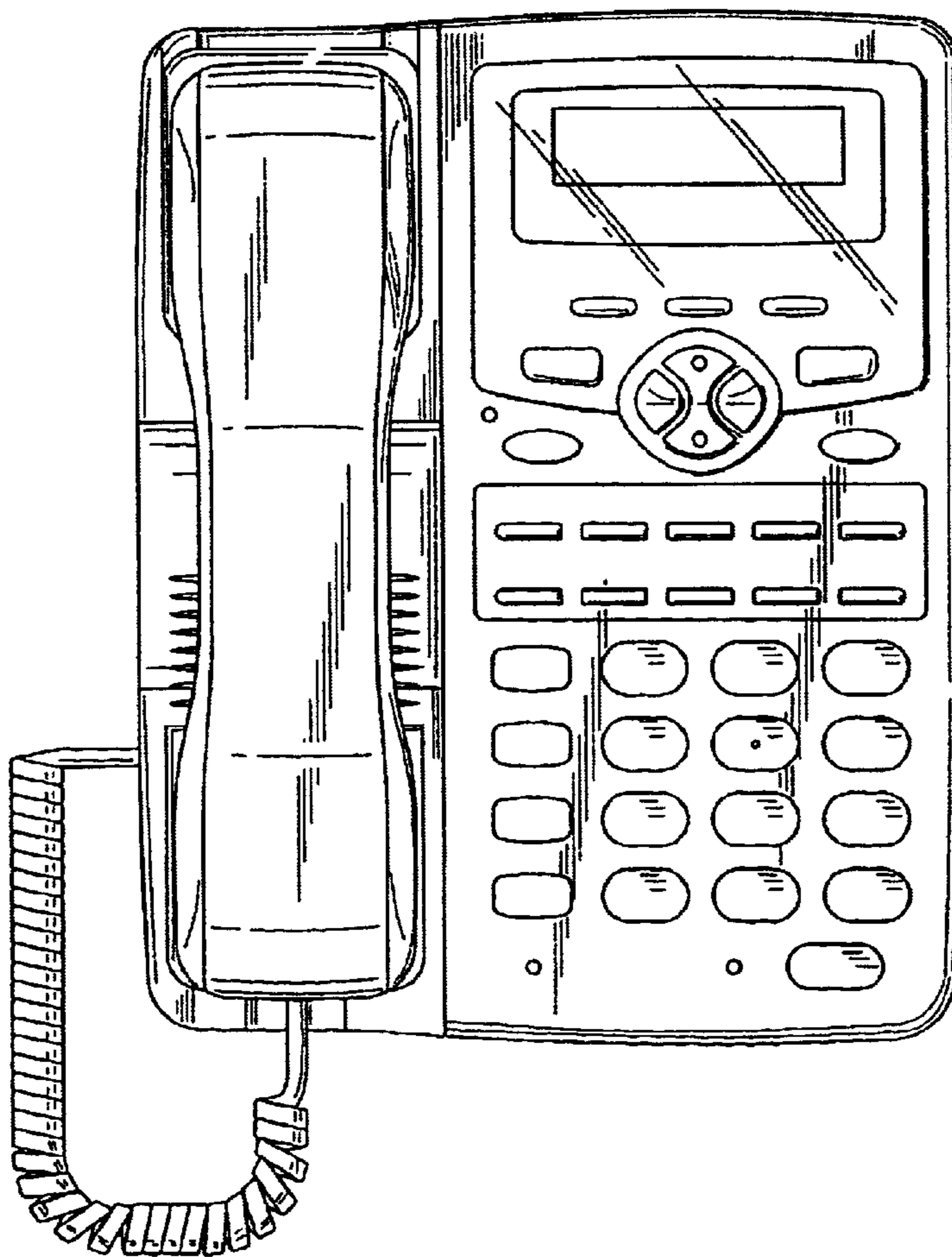



FIG 6

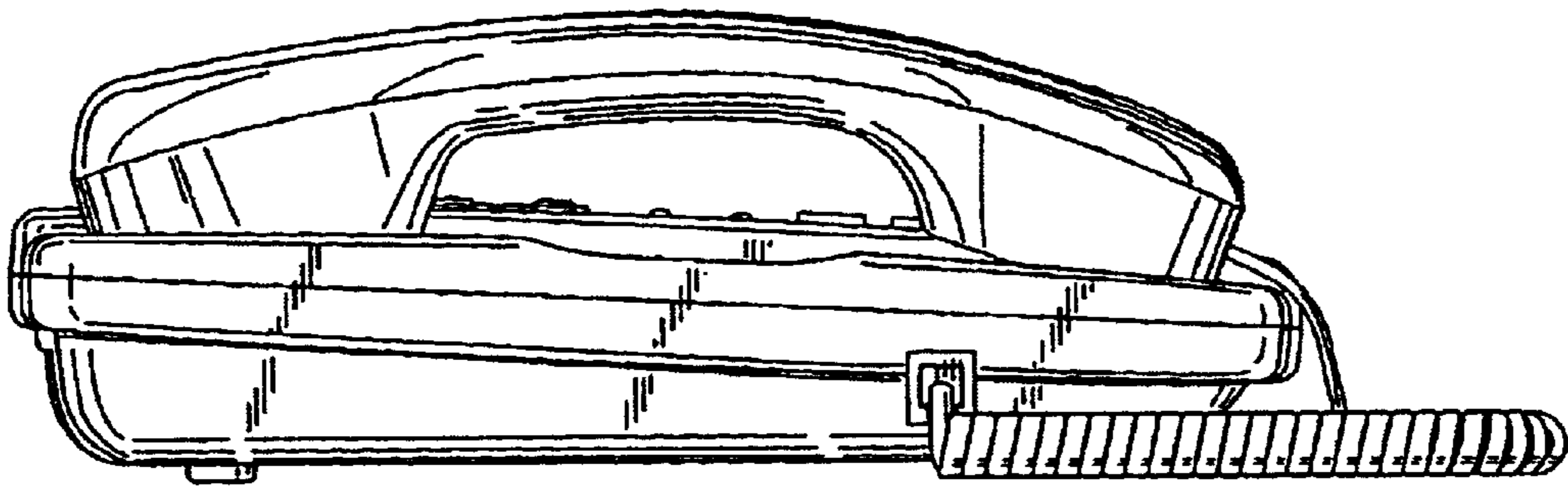

FIG 7

