



US00D490789S

(12) **United States Design Patent**  
**Watanabe**

(10) **Patent No.:** **US D490,789 S**

(45) **Date of Patent:** **\*\* Jun. 1, 2004**

(54) **CELL PHONE**

(75) **Inventor:** **Takayuki Watanabe, Tokyo (JP)**

(73) **Assignee:** **Matsushita Electric Works, Ltd. (JP)**

(\*\*) **Term:** **14 Years**

(21) **Appl. No.:** **29/168,333**

(22) **Filed:** **Sep. 30, 2002**

(51) **LOC (7) Cl.** ..... **14-03**

(52) **U.S. Cl.** ..... **D14/138**

(58) **Field of Search** ..... D14/137, 138,  
D14/218, 147-148, 247-248, 144, 240,  
341-347; 379/433.01-433.13, 419, 434,  
428.01-428.04, 420.01-420.04, 440; 455/550.1-90.3;  
D21/517; 345/168, 169

(56) **References Cited**

**U.S. PATENT DOCUMENTS**

D282,738 S	*	2/1986	Nichols	.....	D14/138
D289,288 S	*	4/1987	Muenschler et al.	.....	D14/138
D298,033 S	*	10/1988	Hotsumi et al.	.....	D14/138
D302,680 S	*	8/1989	Fujita et al.	.....	D14/138
5,276,916 A	*	1/1994	Pawlish et al.	.....	455/575.1
5,365,570 A	*	11/1994	Boubelik	.....	455/565
D358,153 S	*	5/1995	Jackson	.....	D14/245
D375,739 S	*	11/1996	Boykiw	.....	D14/147
5,574,772 A	*	11/1996	Scalisi et al.	.....	455/565
D377,351 S	*	1/1997	Toki et al.	.....	D14/138
D379,810 S	*	6/1997	Giordano, Jr. et al.	.....	D14/138
D379,980 S	*	6/1997	Biskup et al.	.....	D14/138
D382,555 S	*	8/1997	Biskup et al.	.....	D14/138
D382,872 S	*	8/1997	Nagele et al.	.....	D14/138
5,661,641 A	*	8/1997	Shindo	.....	361/814
D383,127 S	*	9/1997	Giordano, Jr. et al.	.....	D14/138
5,677,949 A	*	10/1997	Macor	.....	379/354
5,786,789 A	*	7/1998	Janky	.....	342/357.1
D397,109 S	*	8/1998	Hockenberry et al.	.....	D14/137
5,822,703 A	*	10/1998	Araki	.....	455/564
D405,084 S	*	2/1999	Scalisi et al.	.....	D14/191
D407,718 S	*	4/1999	Lee	.....	D14/138
D413,117 S	*	8/1999	Chintala et al.	.....	D14/138
D414,765 S	*	10/1999	Park	.....	D14/138

D421,006 S \* 2/2000 Shindo et al. .... D14/147  
6,115,597 A \* 9/2000 Kroll et al. .... 455/404.1

(List continued on next page.)

*Primary Examiner*—Jeffrey Asch

(74) *Attorney, Agent, or Firm*—Osha Novak & May L.L.P.

(57) **CLAIM**

The ornamental design for a cell phone, as shown and described.

**DESCRIPTION**

FIG. 1 is a front view of the design according to the invention;

FIG. 2 is a rear view of the design according to the invention;

FIG. 3 is a top view of the design according to the invention;

FIG. 4 is a bottom view of the design according to the invention;

FIG. 5 is a left side view of the design according to the invention;

FIG. 6 is a right side view of the design according to the invention;

FIG. 7 is a perspective view of the design according to the invention;

FIG. 8 is a front view of the design in an alternate position for use according the invention;

FIG. 9 is a rear view of the design in an alternate position for use according to the invention;

FIG. 10 is a top view of the design according to the invention;

FIG. 11 is a bottom view of the design according to the invention;

FIG. 12 is a left side view of the design in an alternate position for use according to the invention;

FIG. 13 is a right side view of the design in an alternate position for use according to the invention; and,

FIG. 14 is a perspective view of the design in an alternate position for use according to the invention.

**1 Claim, 6 Drawing Sheets**

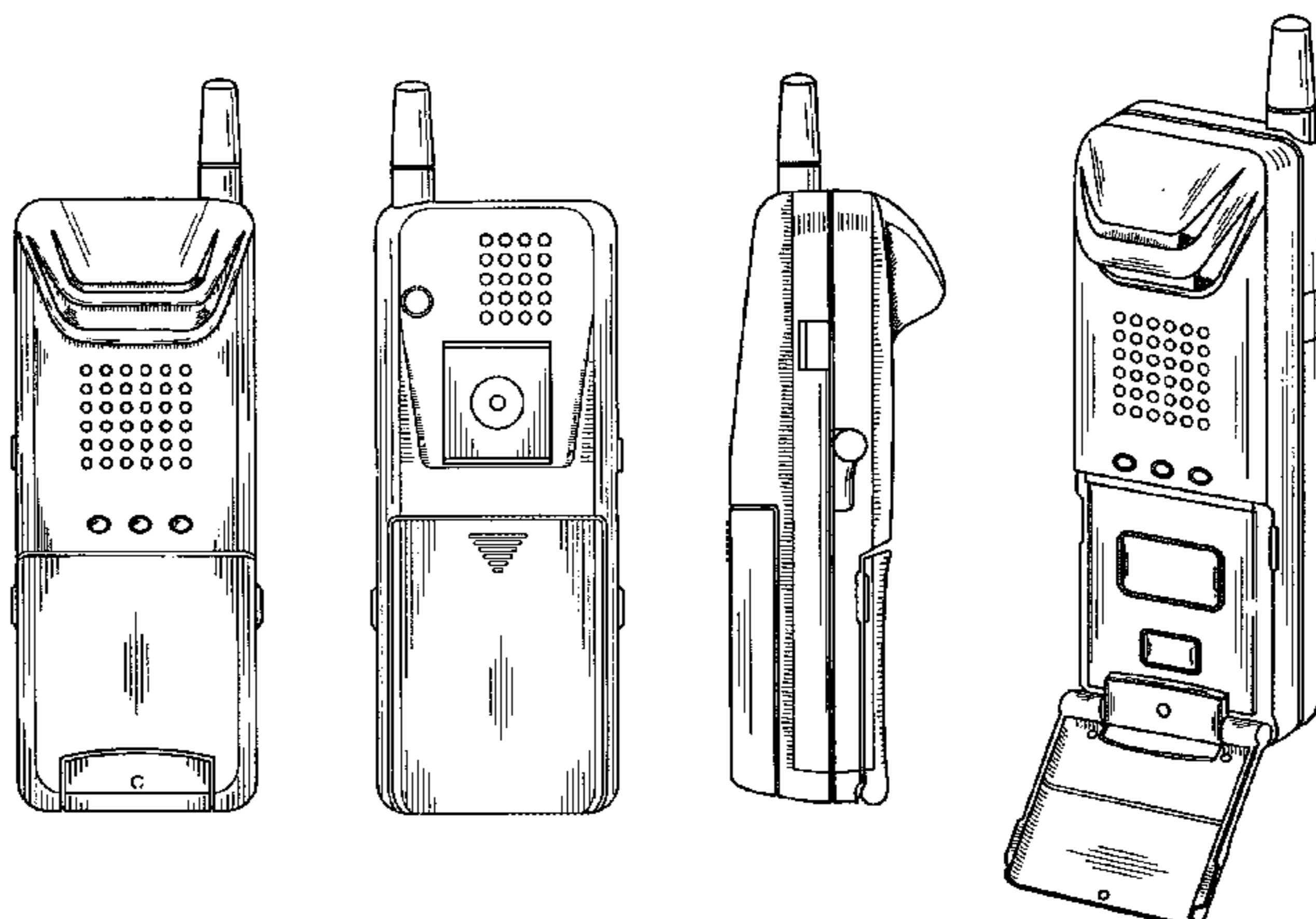

# US D490,789 S

Page 2

---

## U.S. PATENT DOCUMENTS

D434,740 S	*	12/2000	Son et al. ....	D14/138	D468,371 S	*	1/2003	So .....	D21/566
D435,528 S	*	12/2000	Hunt .....	D14/138	D469,367 S	*	1/2003	Mirabelli et al. ....	D10/65
D440,546 S	*	4/2001	Isonaga .....	D14/147	6,529,827 B1	*	3/2003	Beason et al. ....	701/213
D440,954 S	*	4/2001	Boling et al. ....	D14/138	6,580,908 B1	*	6/2003	Kroll et al. ....	455/435.1
6,389,278 B1	*	5/2002	Singh .....	455/414.3	2001/0008839 A1	*	7/2001	Cho .....	455/575.7
D465,214 S	*	11/2002	Mirabelli et al. ....	D14/230					

\* cited by examiner

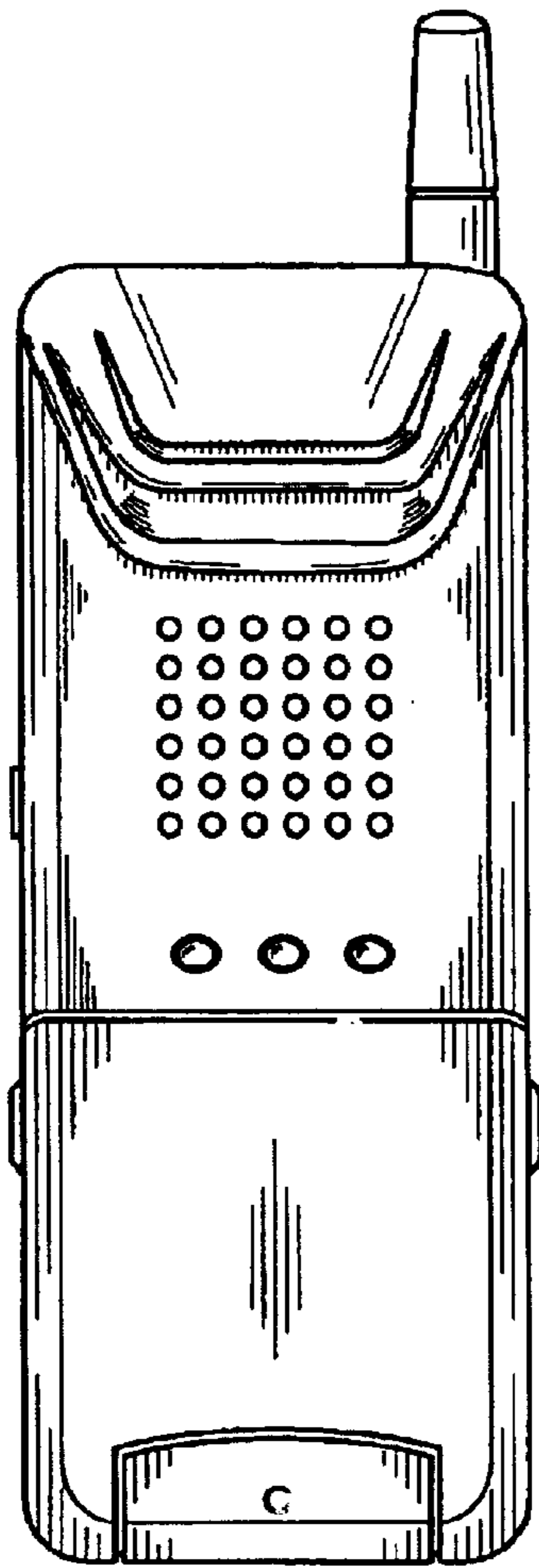

**FIG. 1**

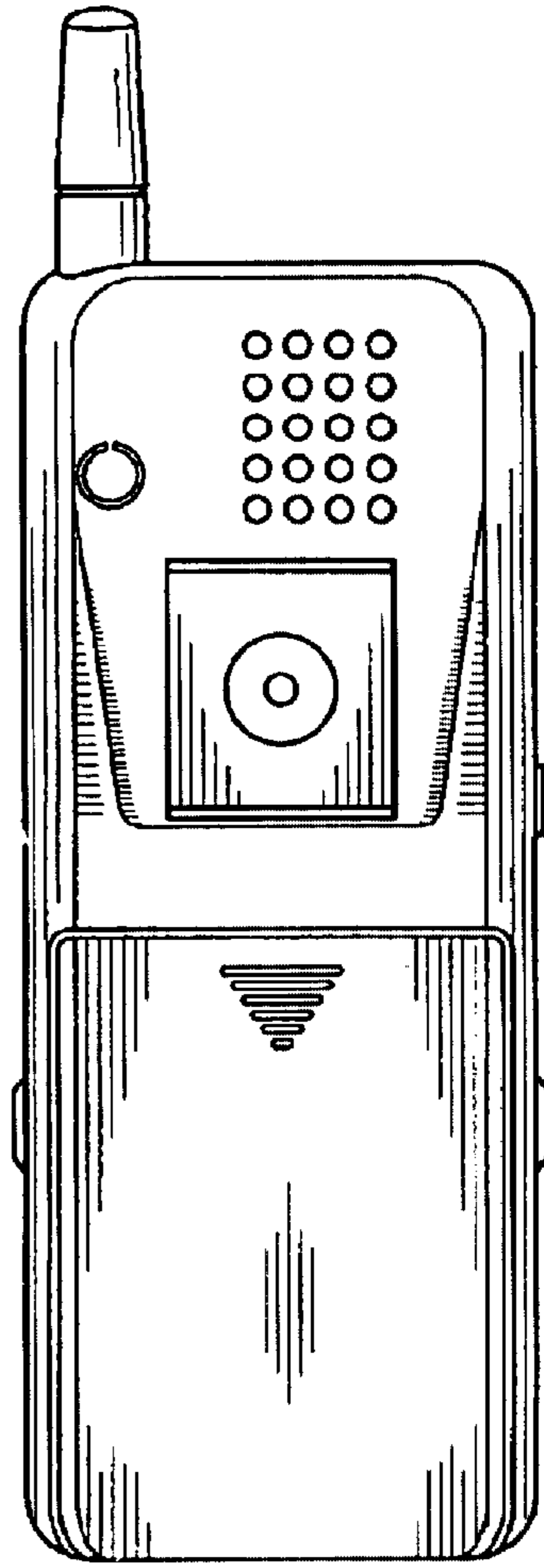

**FIG. 2**

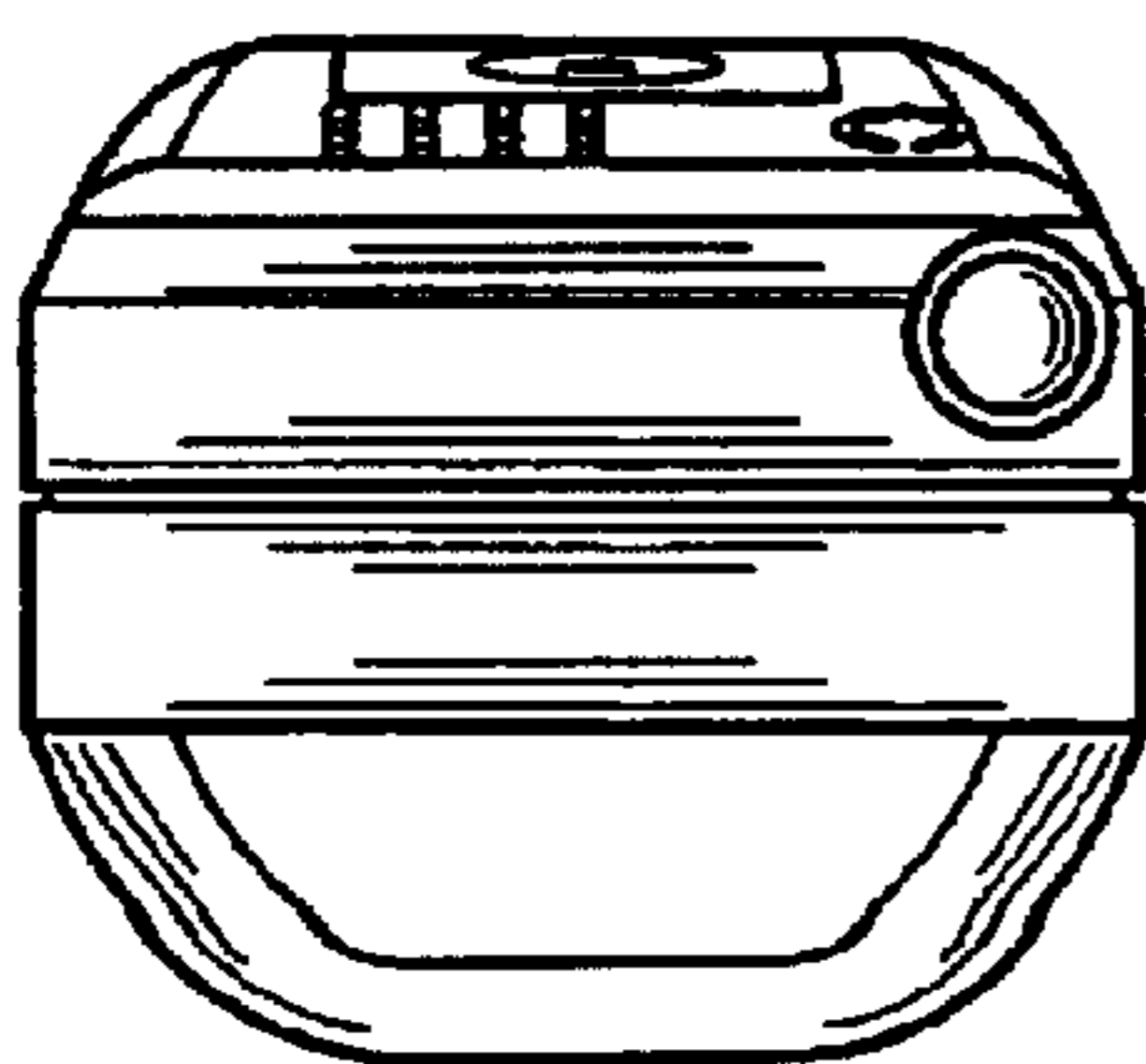

**FIG. 3**

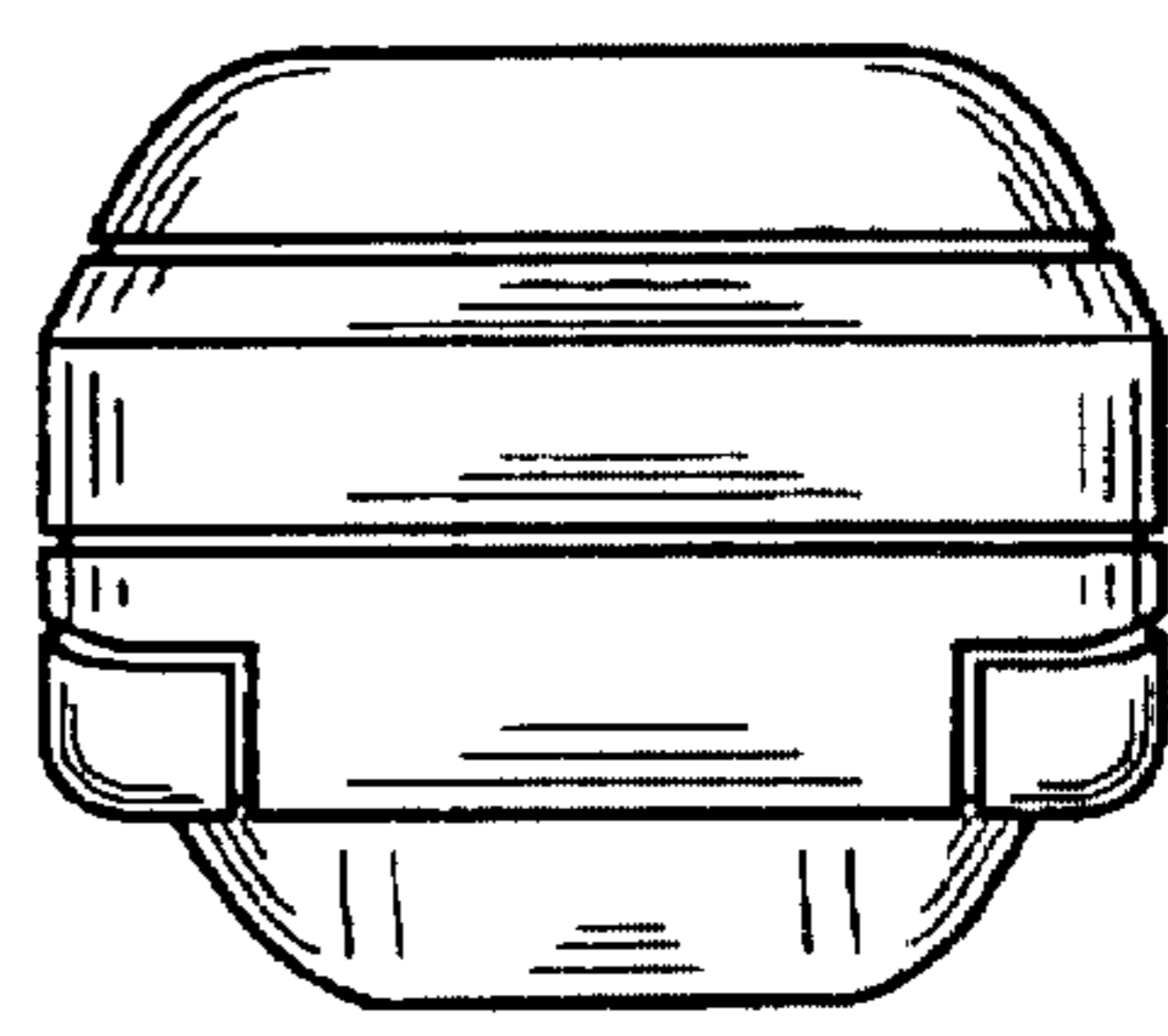

**FIG. 4**

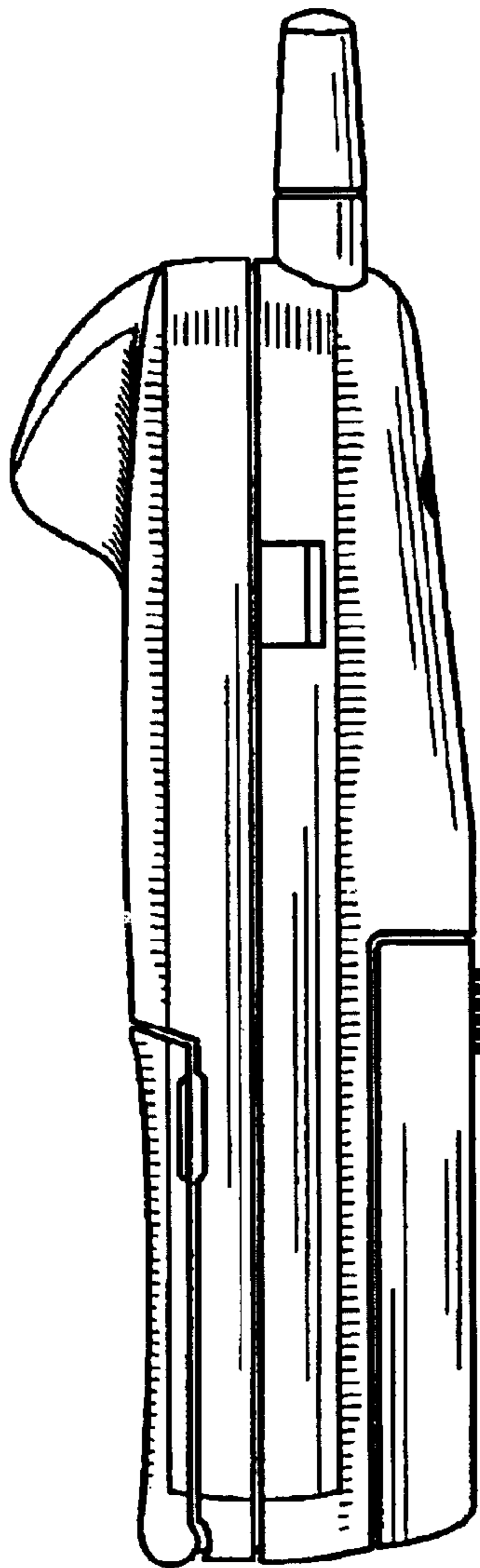

**FIG. 5**

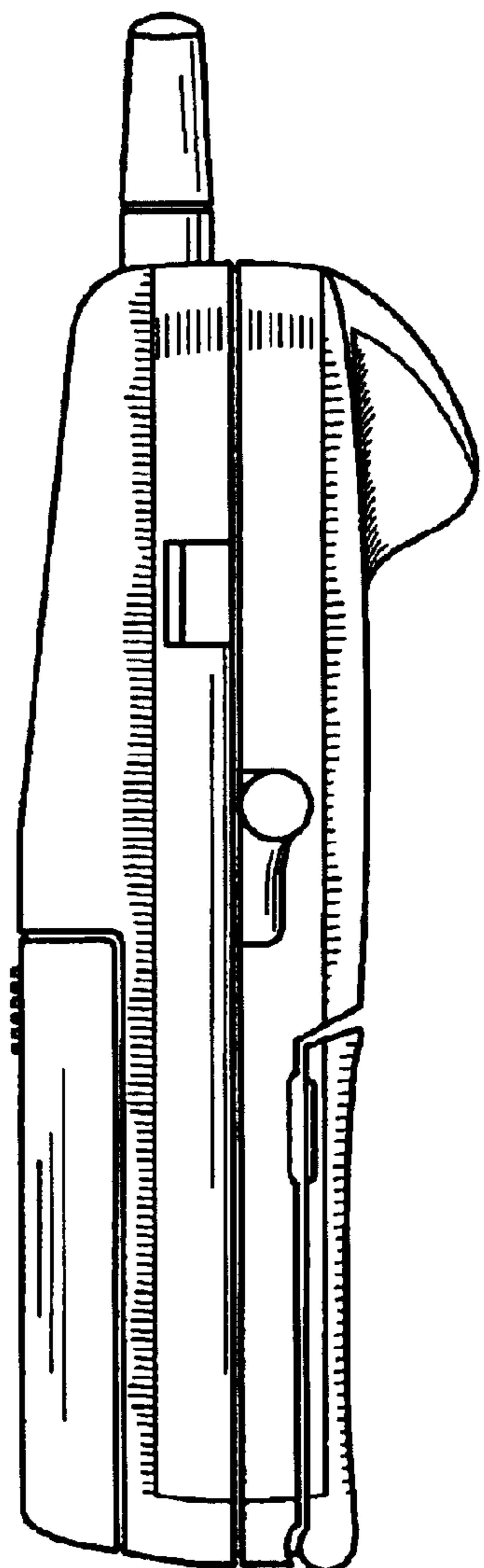

**FIG. 6**

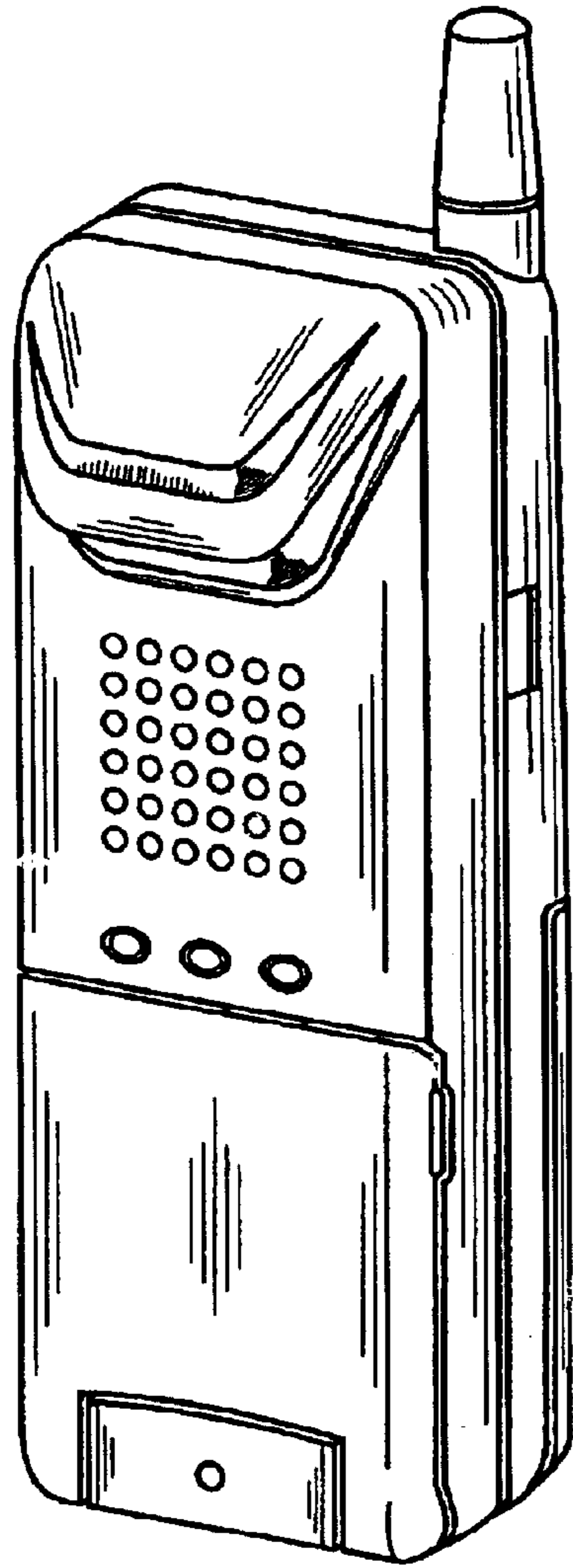

**FIG. 7**

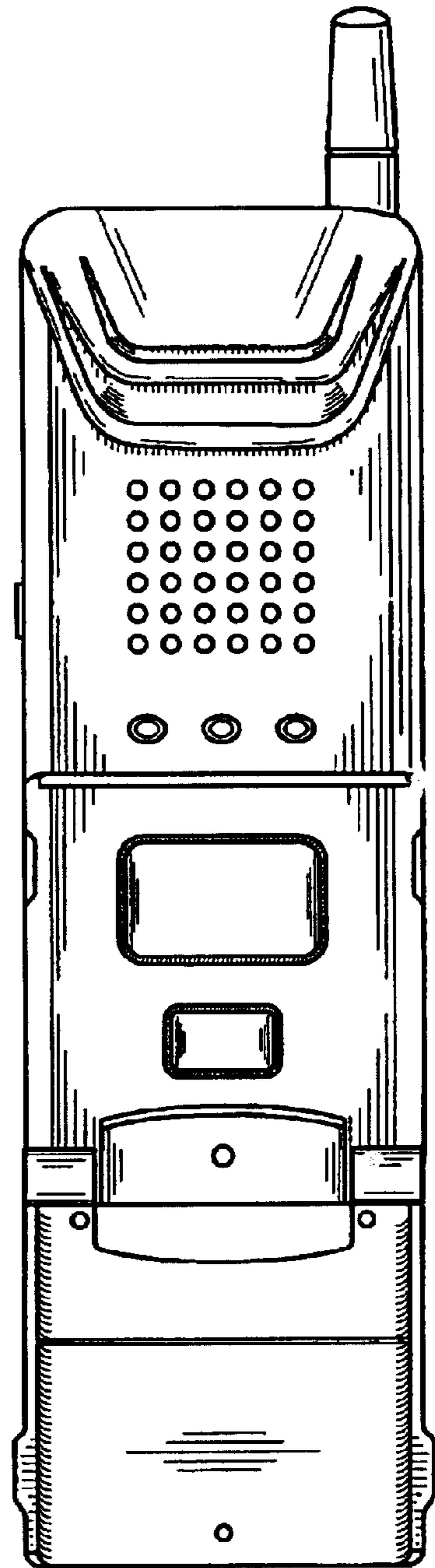

**FIG. 8**

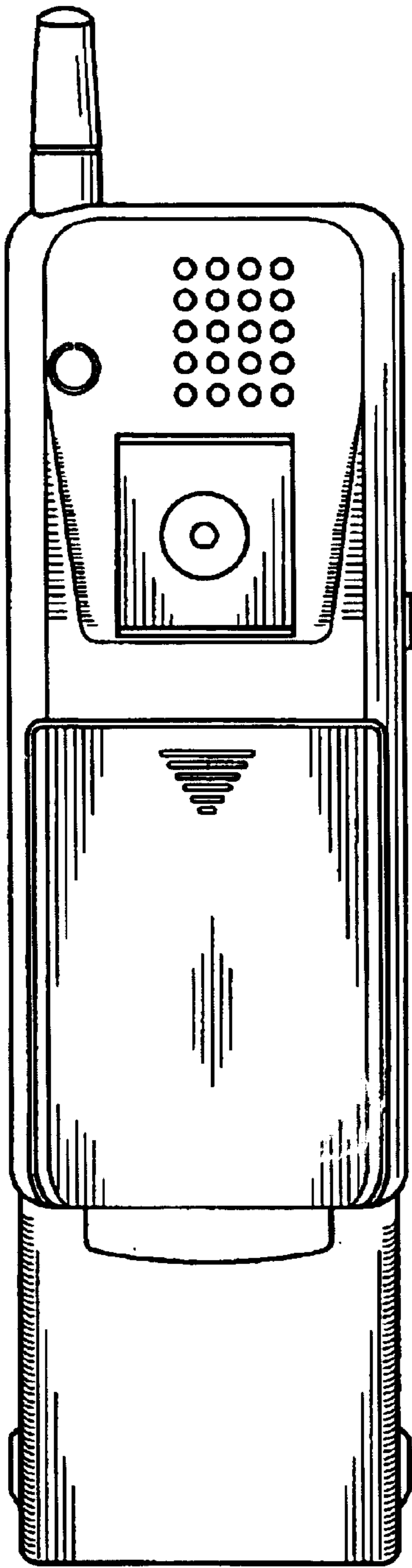

**FIG. 9**

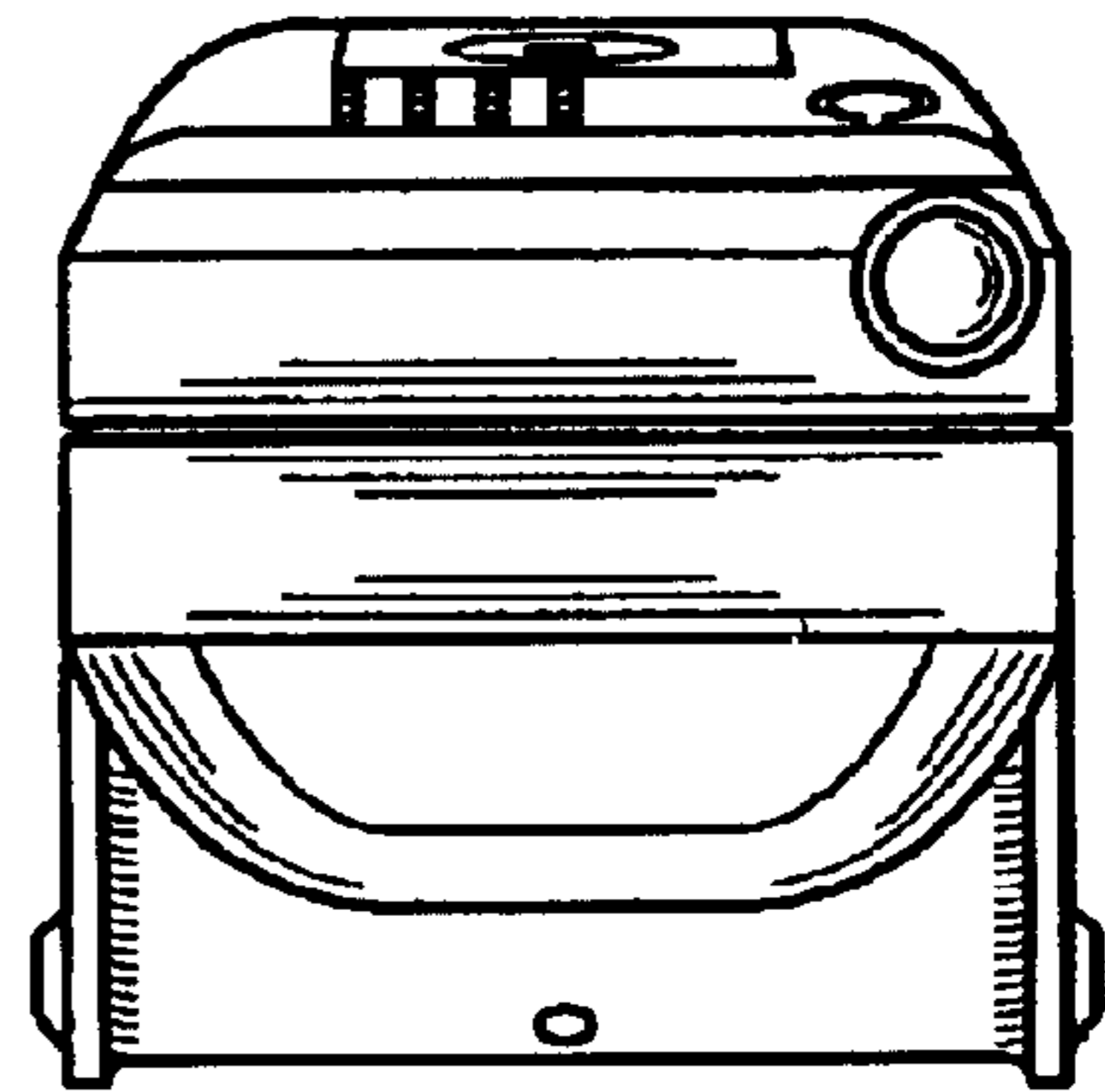

**FIG. 10**

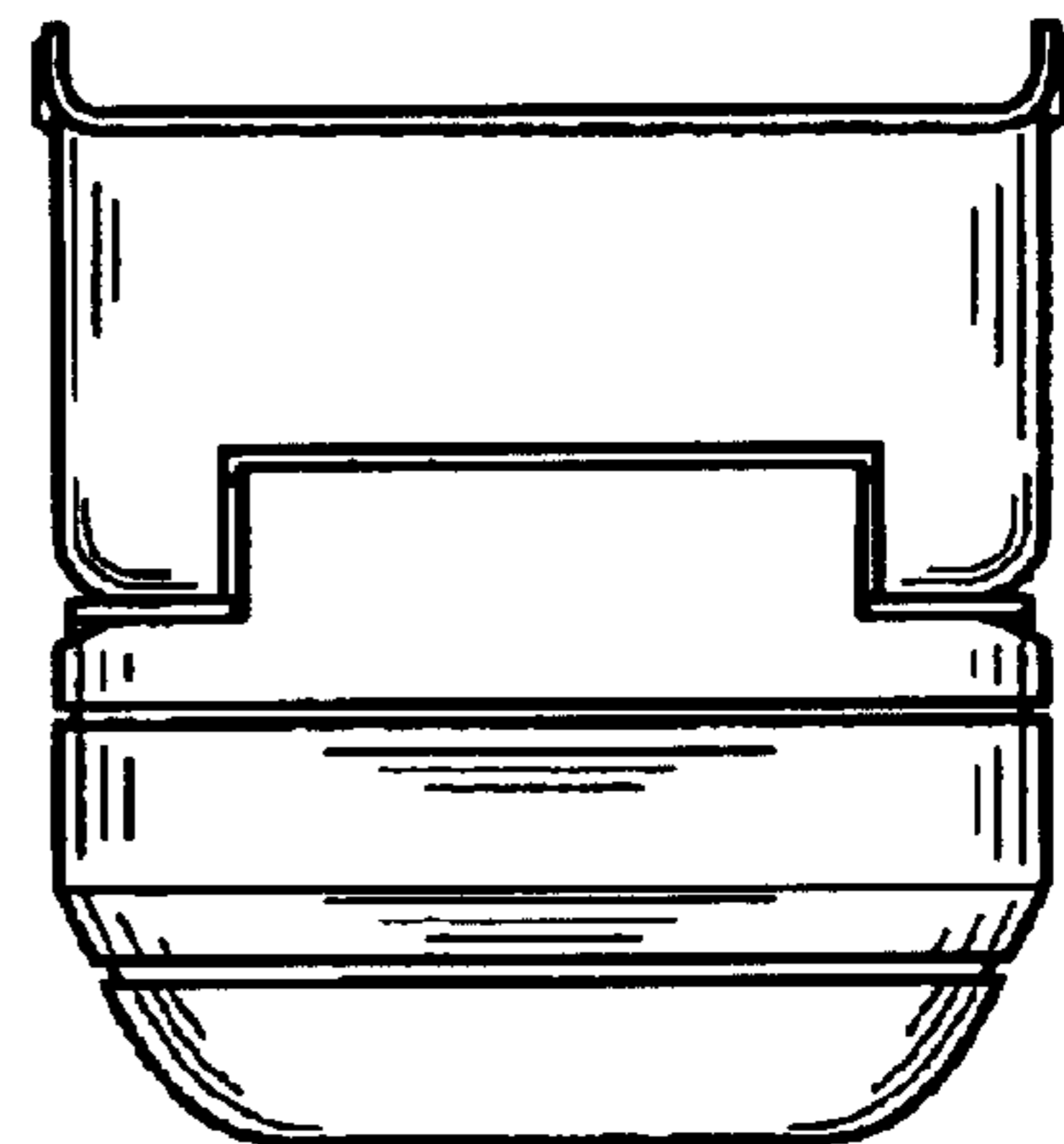

**FIG. 11**

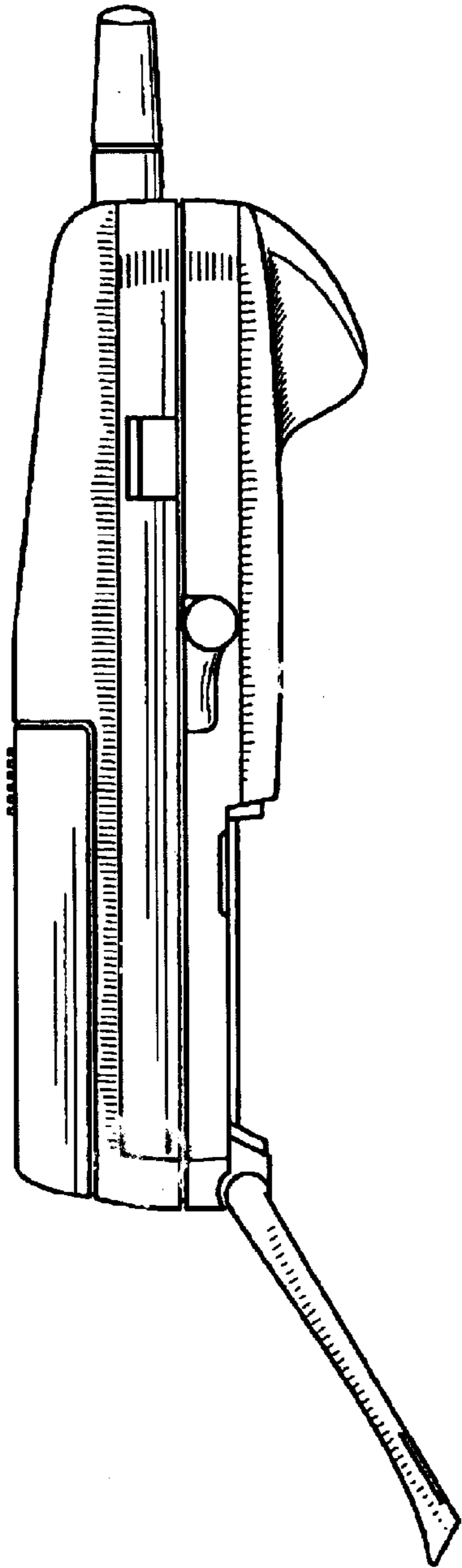

**FIG. 12**

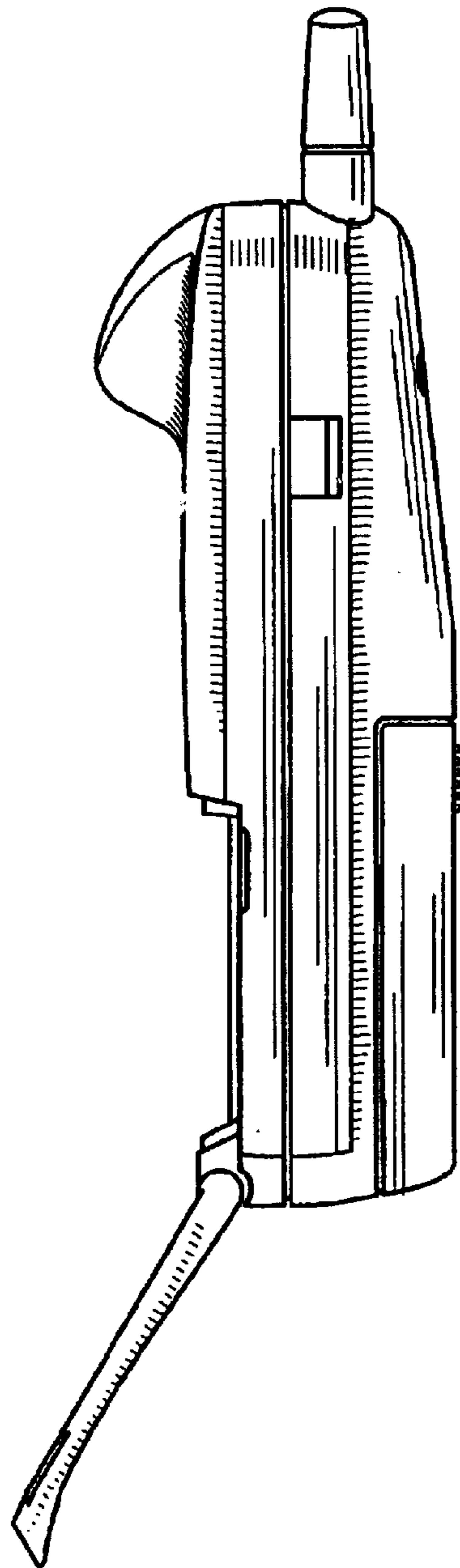

**FIG. 13**

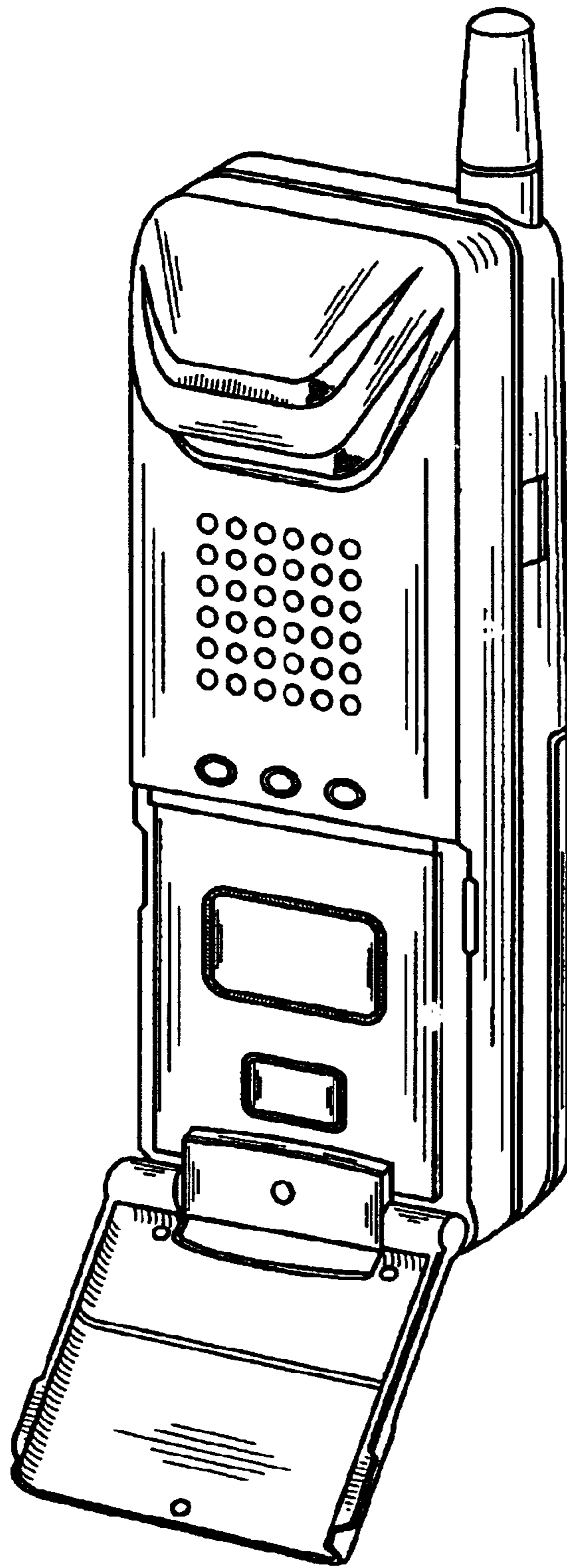

**FIG. 14**