



US00D490767S

(12) **United States Design Patent**
Nagasawa et al.

(10) **Patent No.:** **US D490,767 S**

(45) **Date of Patent:** **** Jun. 1, 2004**

(54) **HOLE PLUG**

(75) Inventors: **Norimasa Nagasawa, Hiroshima (JP);
Noboru Obayashi, Hiroshima (JP)**

(73) Assignee: **Nifco Inc., Yokohama (JP)**

(**) Term: **14 Years**

(21) Appl. No.: **29/181,413**

(22) Filed: **May 12, 2003**

(30) **Foreign Application Priority Data**

Nov. 13, 2002 (JP) 2002-031255

(51) **LOC (7) Cl.** **12-01**

(52) **U.S. Cl.** **D12/400**

(58) **Field of Search** D12/400, 401,
D12/415, 190, 192, 195, 196; 220/324,
787-89; 24/453, 451

(56) **References Cited**

U.S. PATENT DOCUMENTS

2,552,917 A * 5/1951 Becker 220/787

3,168,961 A * 2/1965 Yates 220/787
4,091,962 A * 5/1978 van Buren, Jr. 220/787 X
4,534,088 A * 8/1985 Ricke 220/787 X

* cited by examiner

Primary Examiner—Brian N. Vinson

(74) *Attorney, Agent, or Firm*—Kanesaka & Takeuchi

(57) **CLAIM**

The ornamental design for a hole plug, as shown and described.

DESCRIPTION

FIG. 1 is a front view of a hole plug showing my new design;
FIG. 2 is a rear view thereof;
FIG. 3 is a left side view thereof;
FIG. 4 is a right side view thereof;
FIG. 5 is a plan view thereof;
FIG. 6 is a bottom view thereof; and,
FIG. 7 is a sectional view thereof taken along line 7—7 in
FIG. 1.

1 Claim, 3 Drawing Sheets

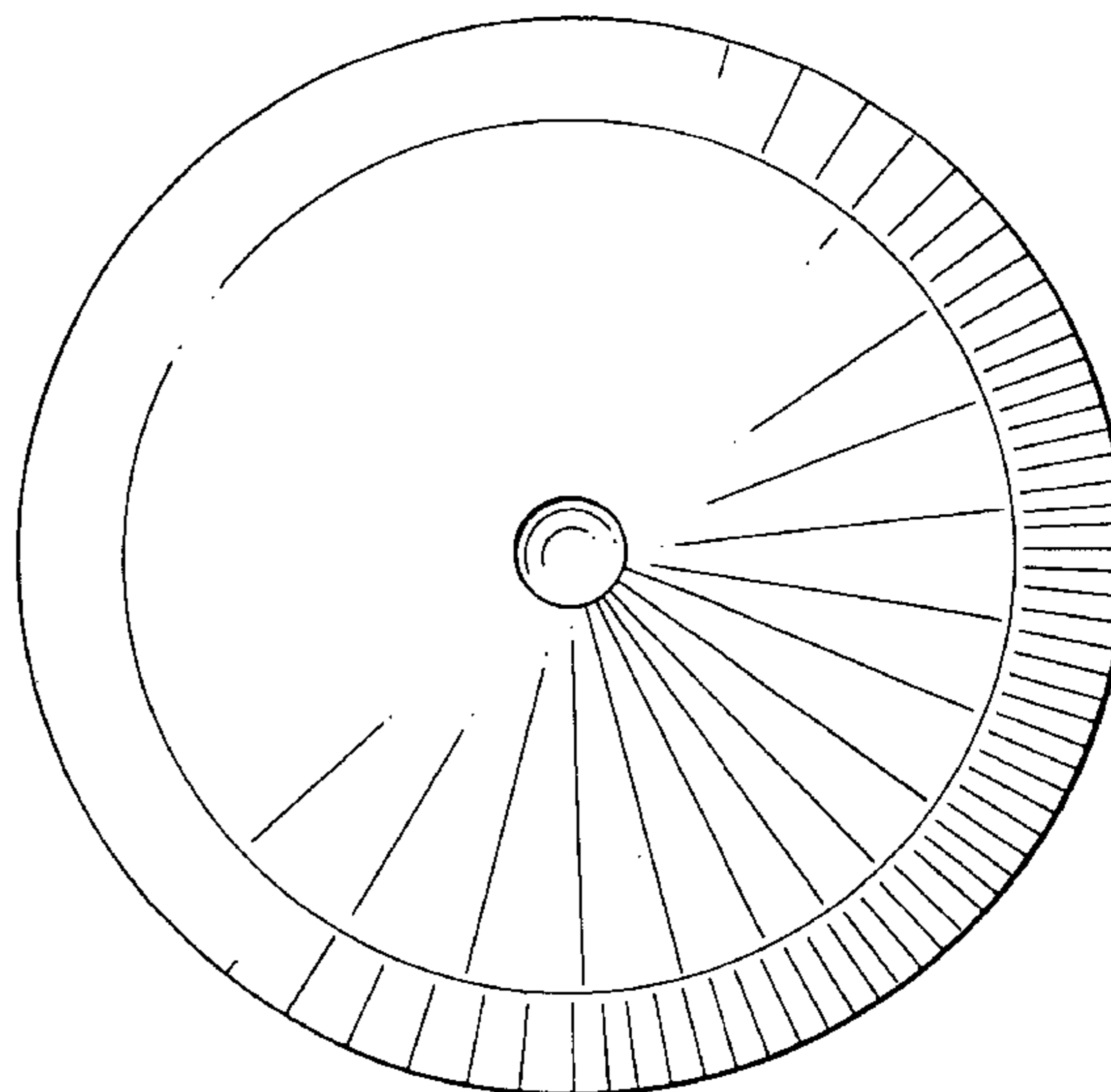
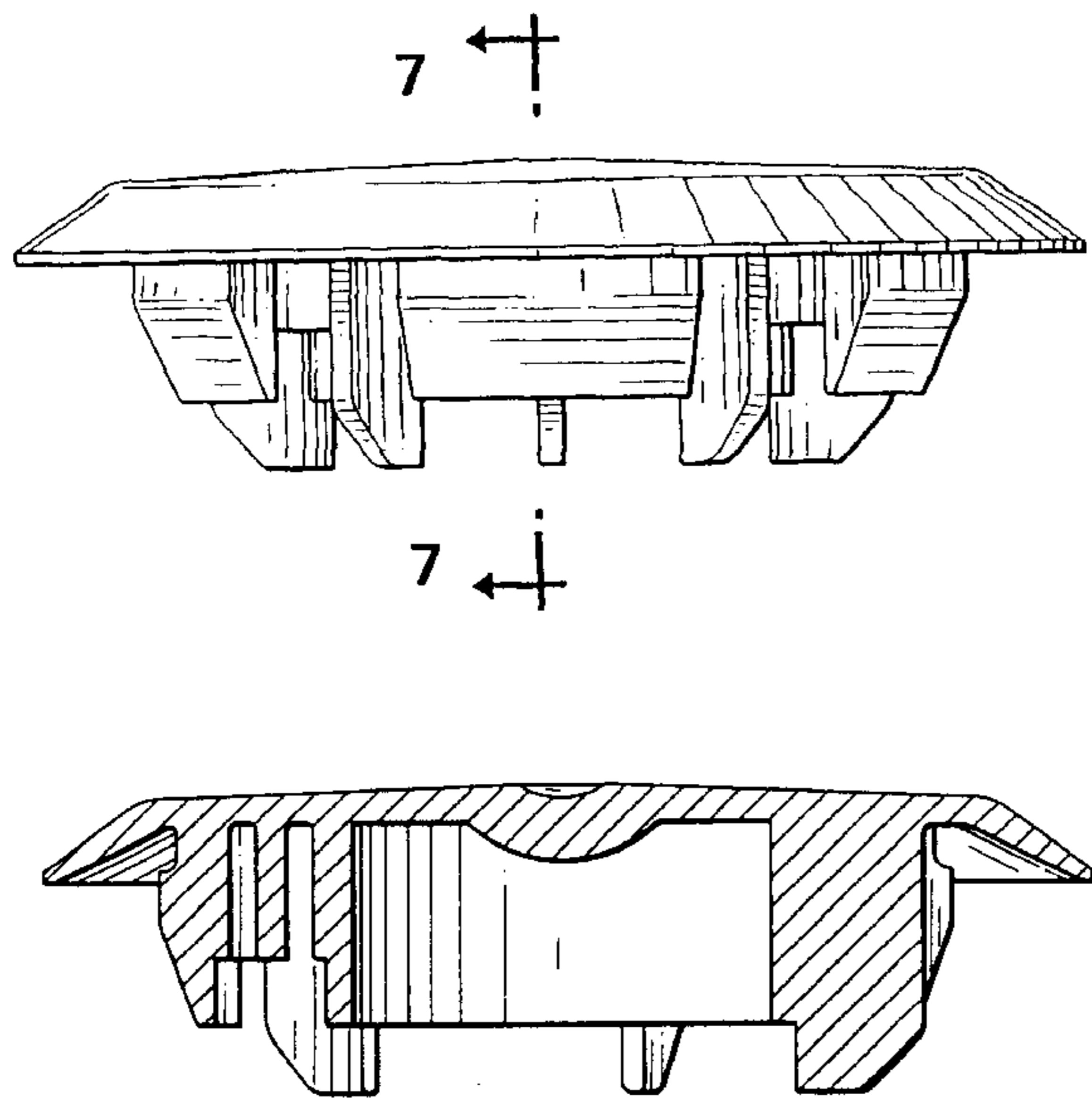

7 ← ↑

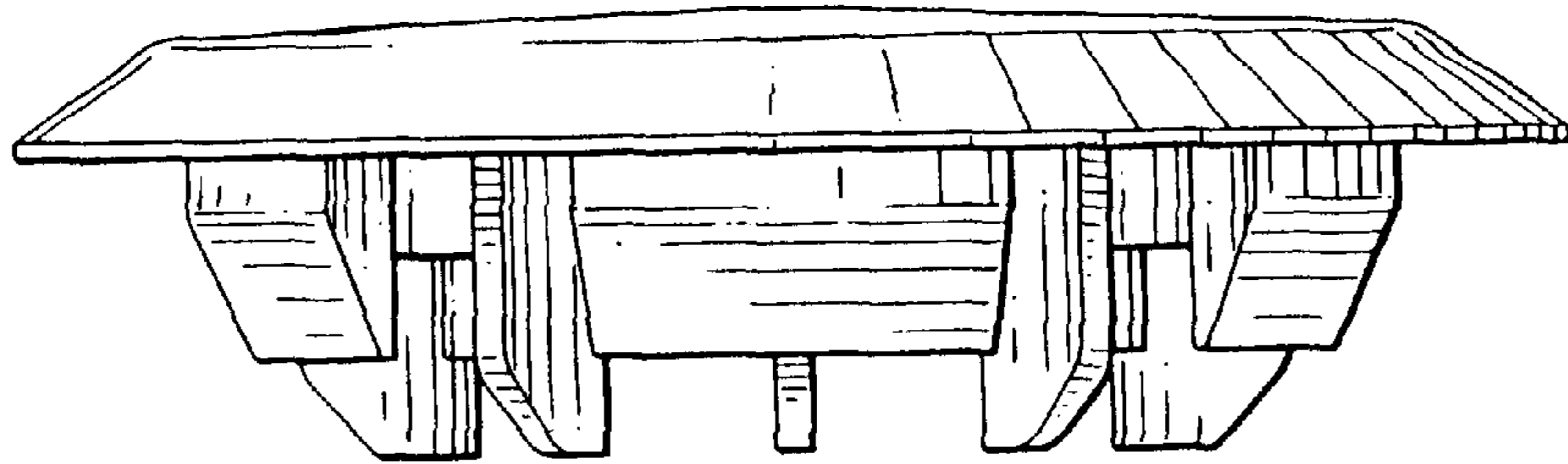

7 ← ↑

FIG. 1

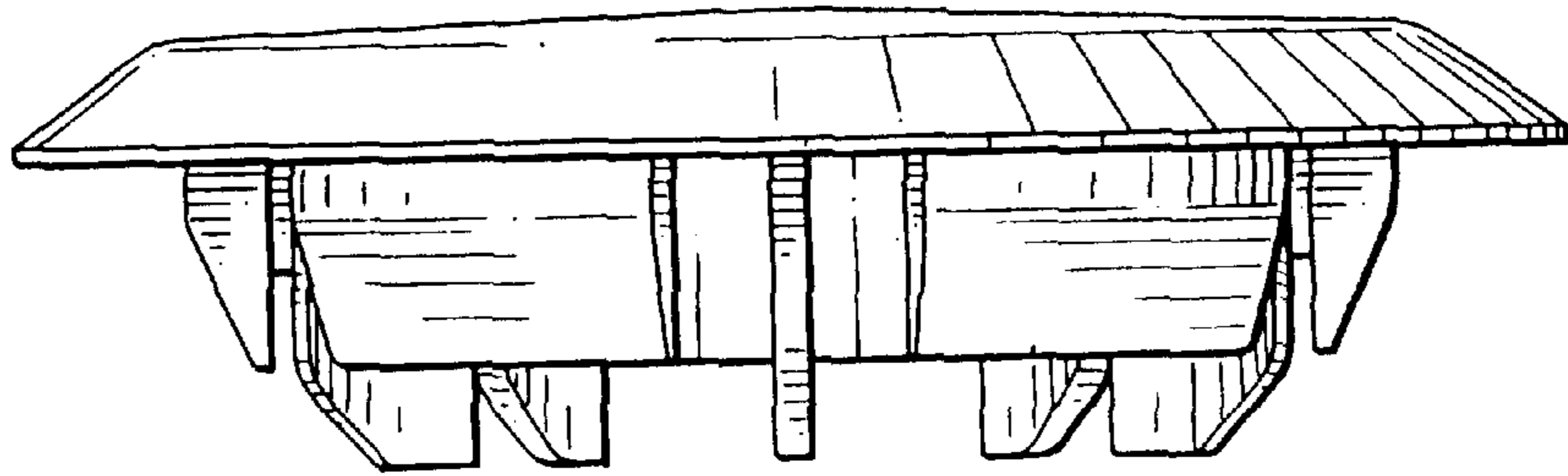

FIG. 2

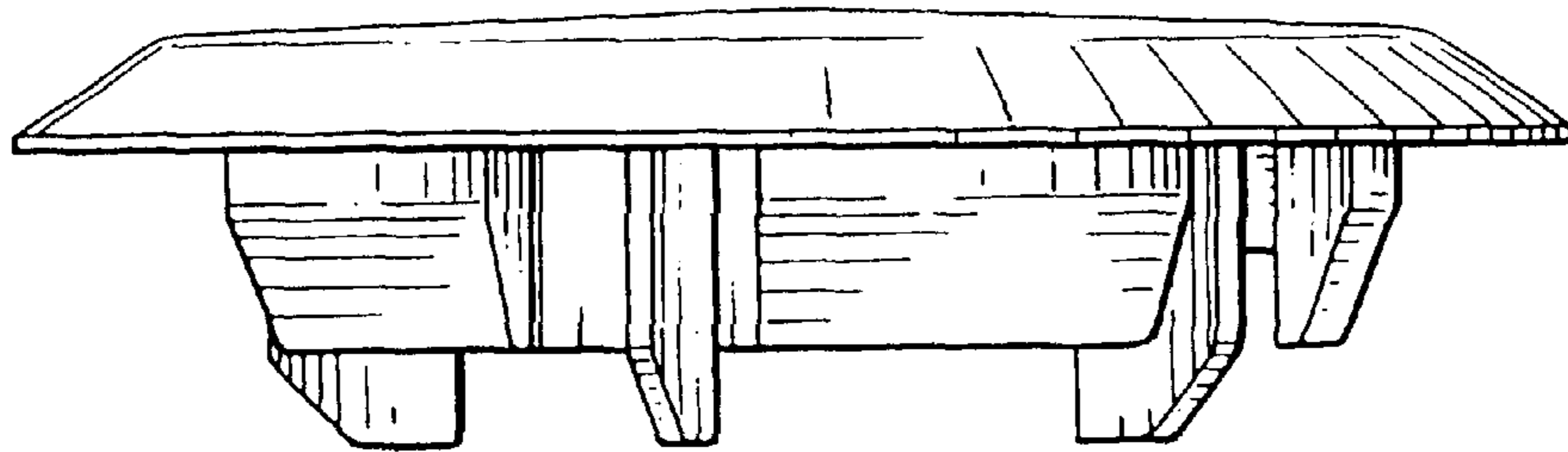

FIG. 3

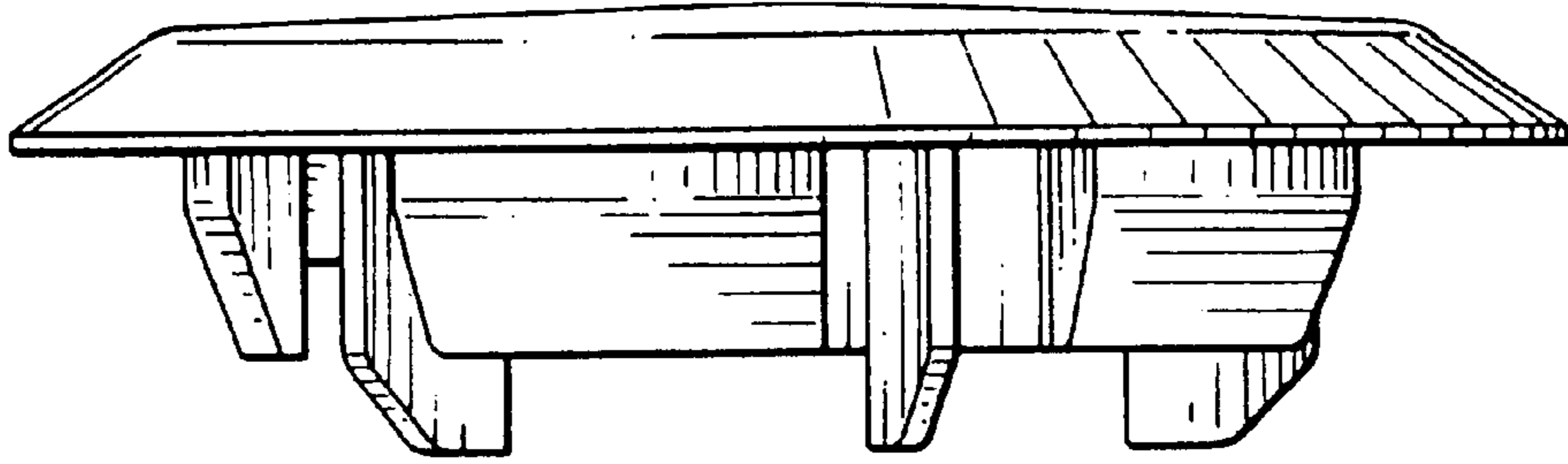

FIG. 4

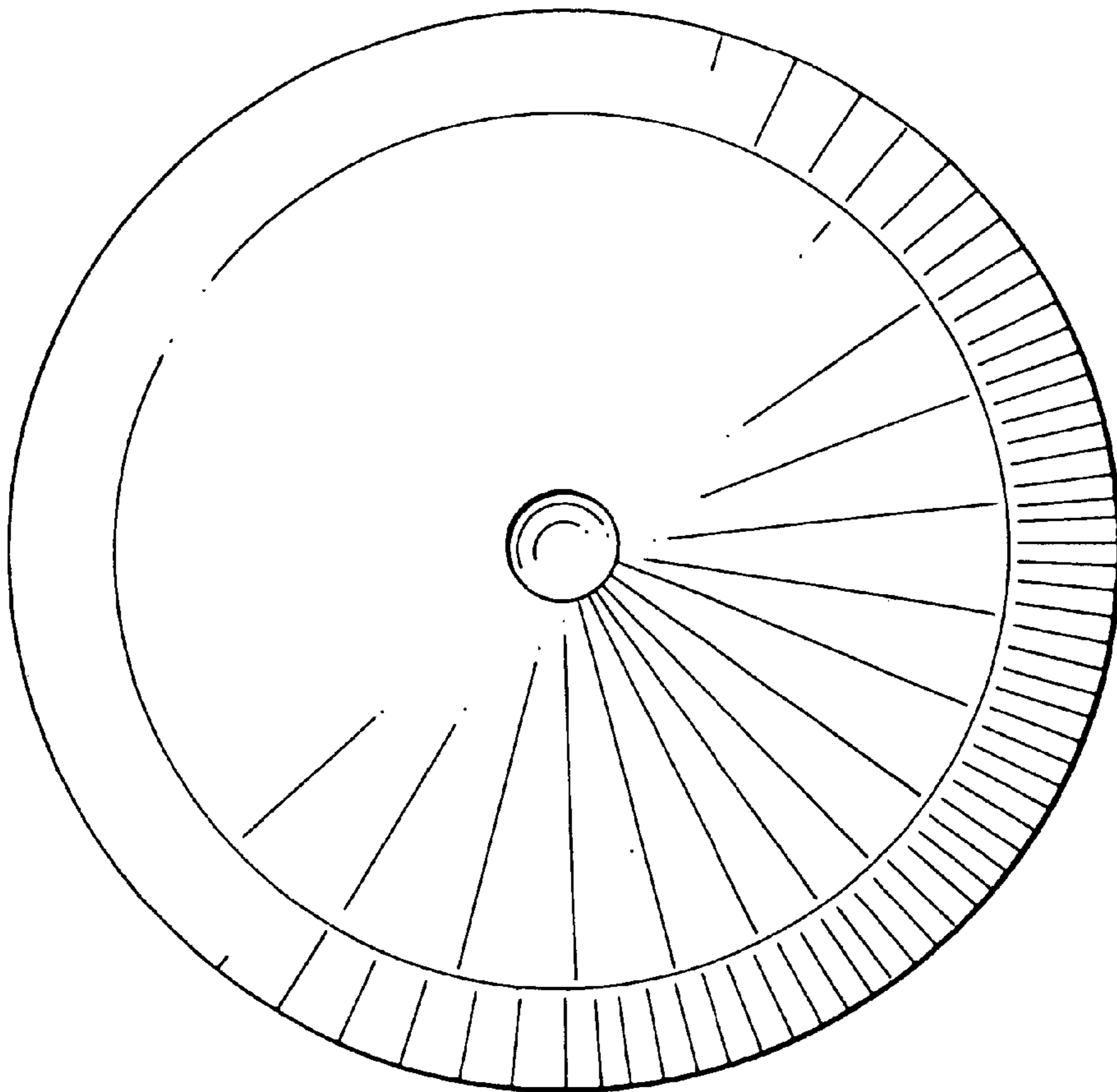

FIG. 5

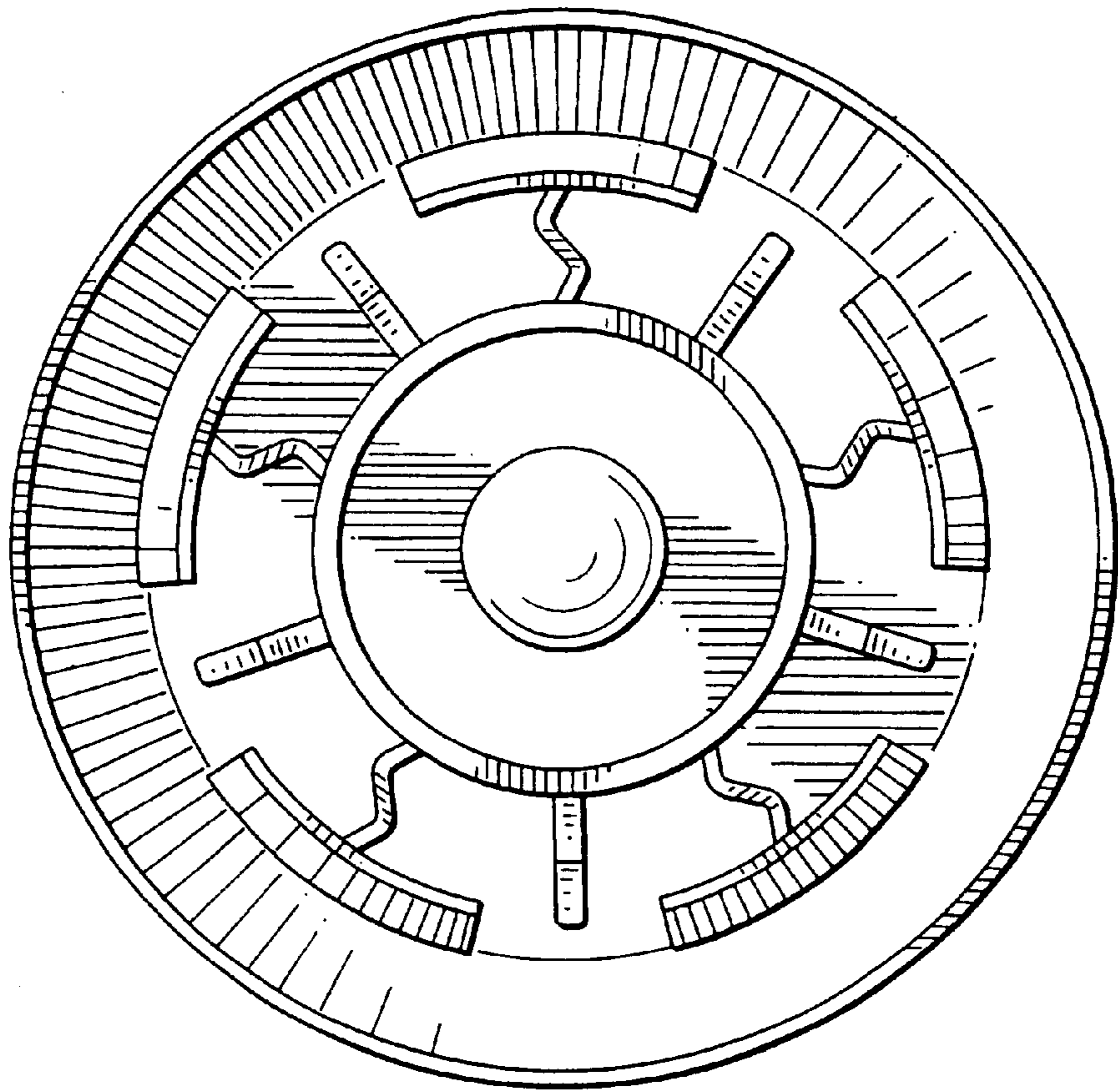

FIG. 6

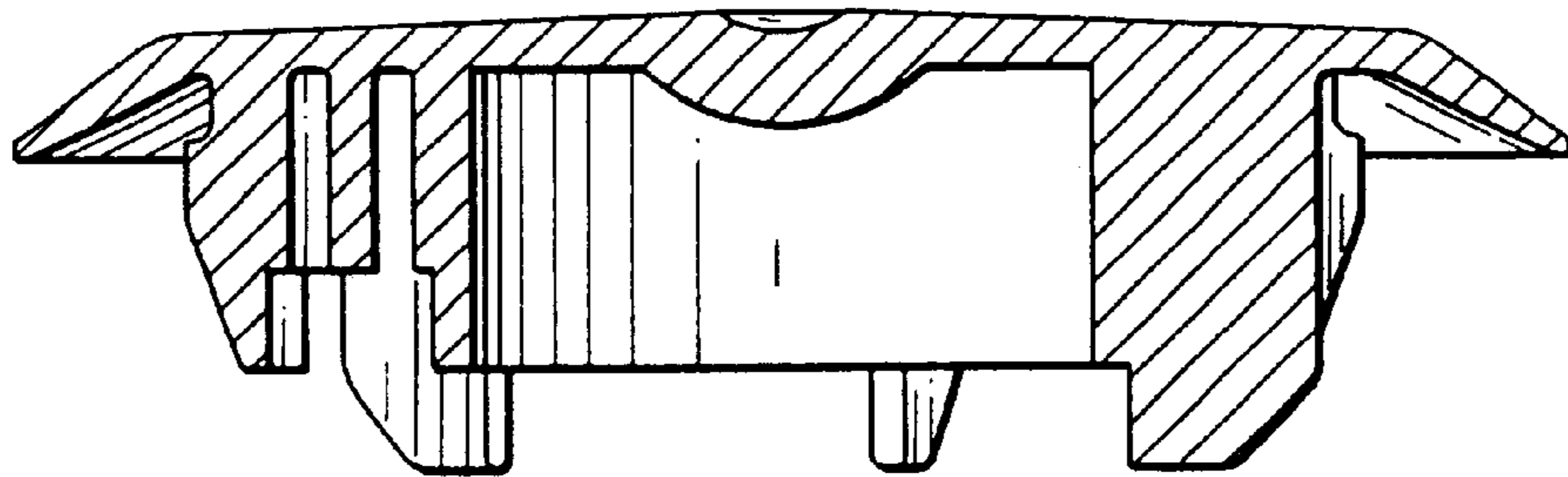

FIG. 7