



US00D490606S

(12) **United States Design Patent**
Beatto

(10) **Patent No.:** **US D490,606 S**

(45) **Date of Patent:** **** Jun. 1, 2004**

(54) **PORTABLE BOOK HOLDER**

(76) Inventor: **Sabat Beatto**, 101-49 131st St.,
Richmond Hill, NY (US) 11419

(**) Term: **14 Years**

(21) Appl. No.: **29/180,349**

(22) Filed: **Apr. 22, 2003**

(51) **LOC (7) Cl.** **03-01**

(52) **U.S. Cl.** **D3/215**

(58) **Field of Search** D3/215; 224/270,
224/250, 257, 258, 600, 607, 608, 610,
623, 930, 908, 625, 265, 276; 361/683,
680, 681

(56) **References Cited**

U.S. PATENT DOCUMENTS

5,421,499	A	*	6/1995	Bauer	224/270
5,551,615	A	*	9/1996	McIntosh	224/270
5,649,654	A	*	7/1997	Hayward, Jr.	224/270
6,019,264	A	*	2/2000	Strieber	224/270
6,381,127	B1	*	4/2002	Maddali et al.	361/683

* cited by examiner

Primary Examiner—Catherine R. Oliver

(57) **CLAIM**

The ornamental design for a portable book holder, as shown and described.

DESCRIPTION

This application is intitled to the benefit of a provisional patent application Ser. No. 60/376,076 filed Apr. 29, 2002.

The portable book holder takes the form of a rigid plastic, wood or metal sheet, approximately 9" wide and 12" long. An attachment belt is provided at the bottom of the fastening around the user's waist. A neck strap is provided at the top of the sheet that fasten around the user's neck.

FIG. 1 is a rear perspective view of the portable book holder showing my new design;

FIG. 2 is a front elevation view thereof;

FIG. 3 is an enlarged top perspective view of the strap closure;

FIG. 4 is an enlarged left side view of the strap closure;

FIG. 5 is a front elevation view of a second embodiment;

FIG. 6 is a top view of the male strap closure;

FIG. 7 is a top view of the female strap closure; and,

FIG. 8 is a top view of both the male and female strap closure, shown connected.

The broken line showing of environment in the drawings is for illustrative purposes only and forms no part of the claimed design.

The strap is shown broken away to indicate indeterminate length.

1 Claim, 3 Drawing Sheets

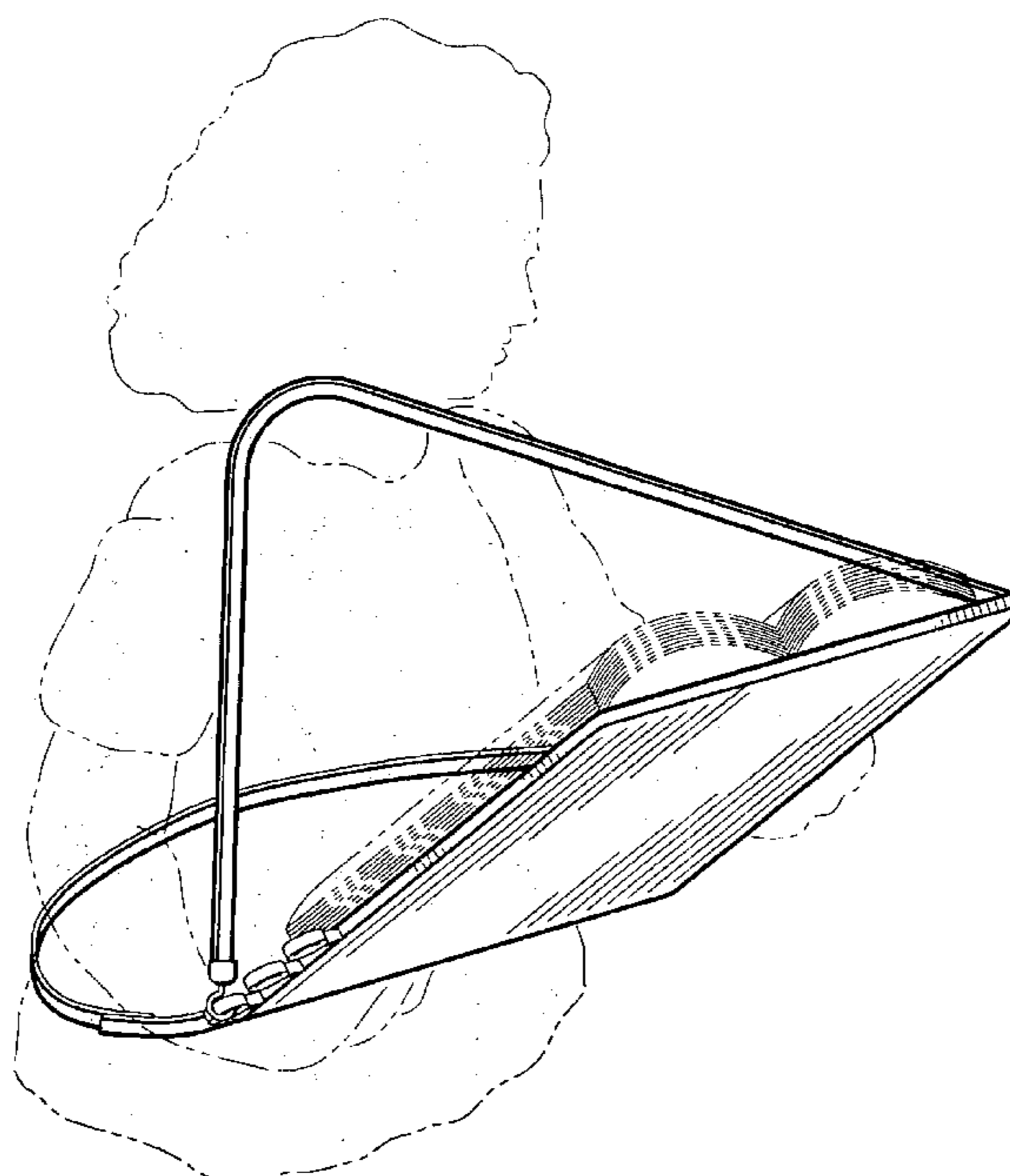

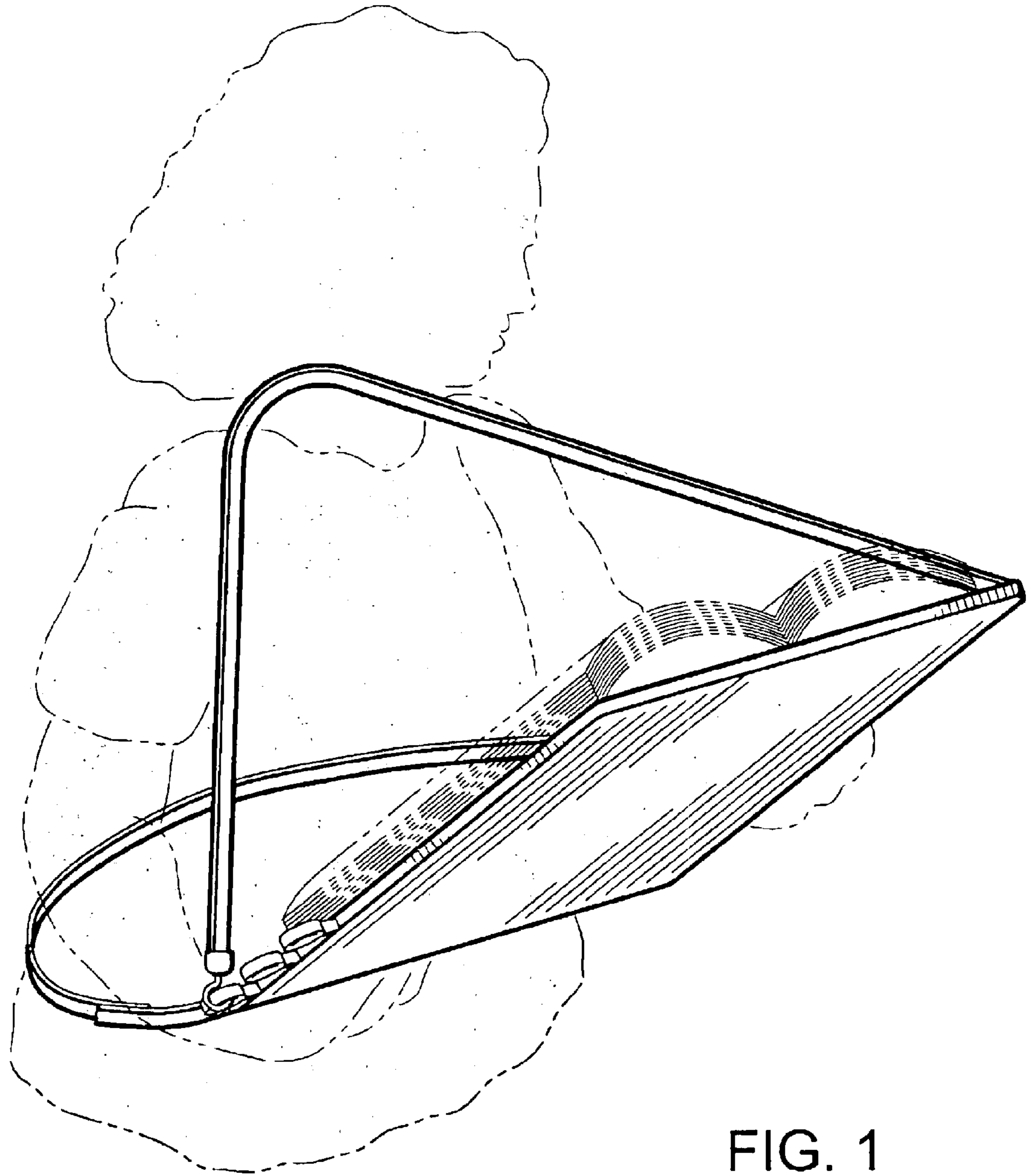

FIG. 1

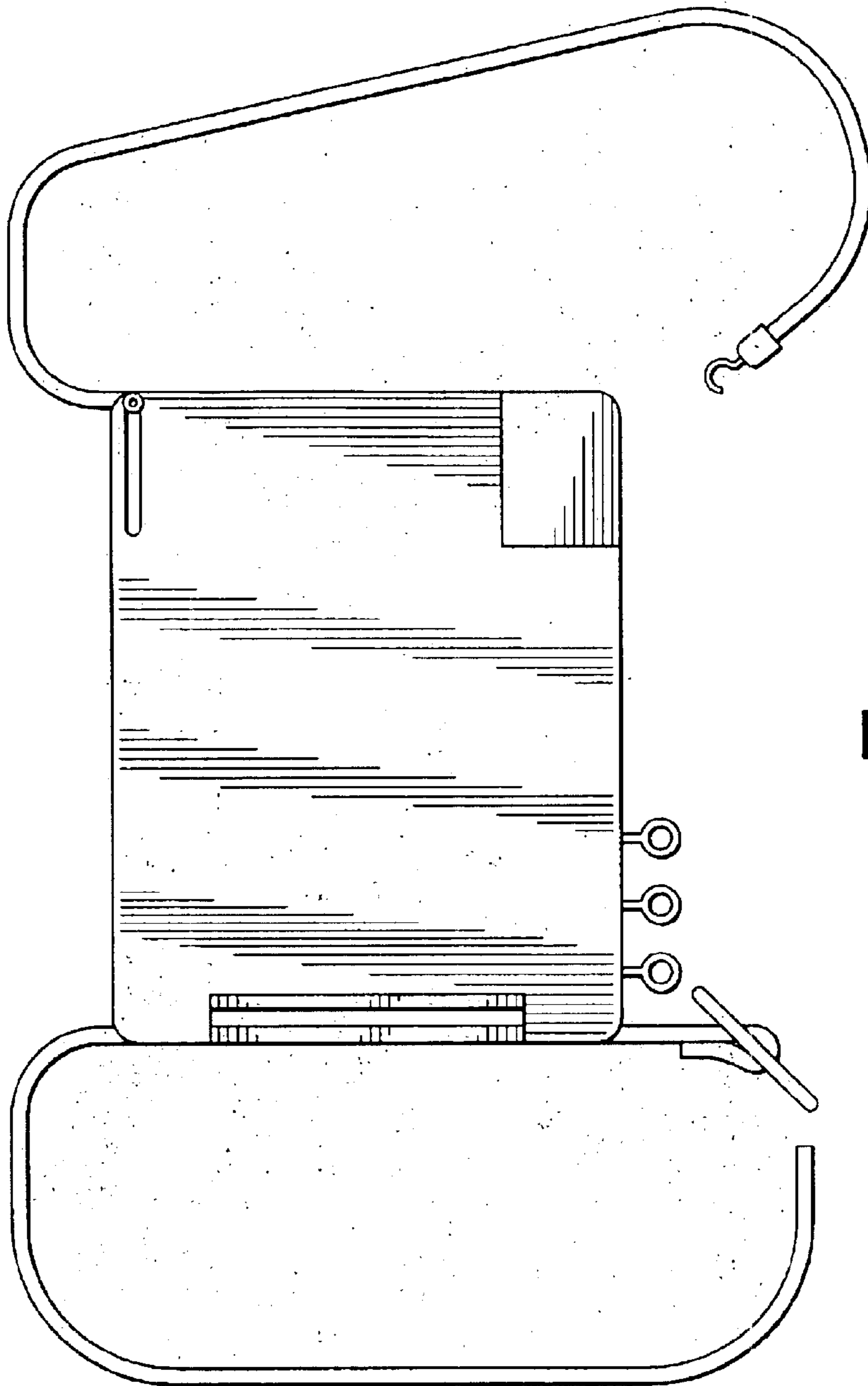

FIG. 2

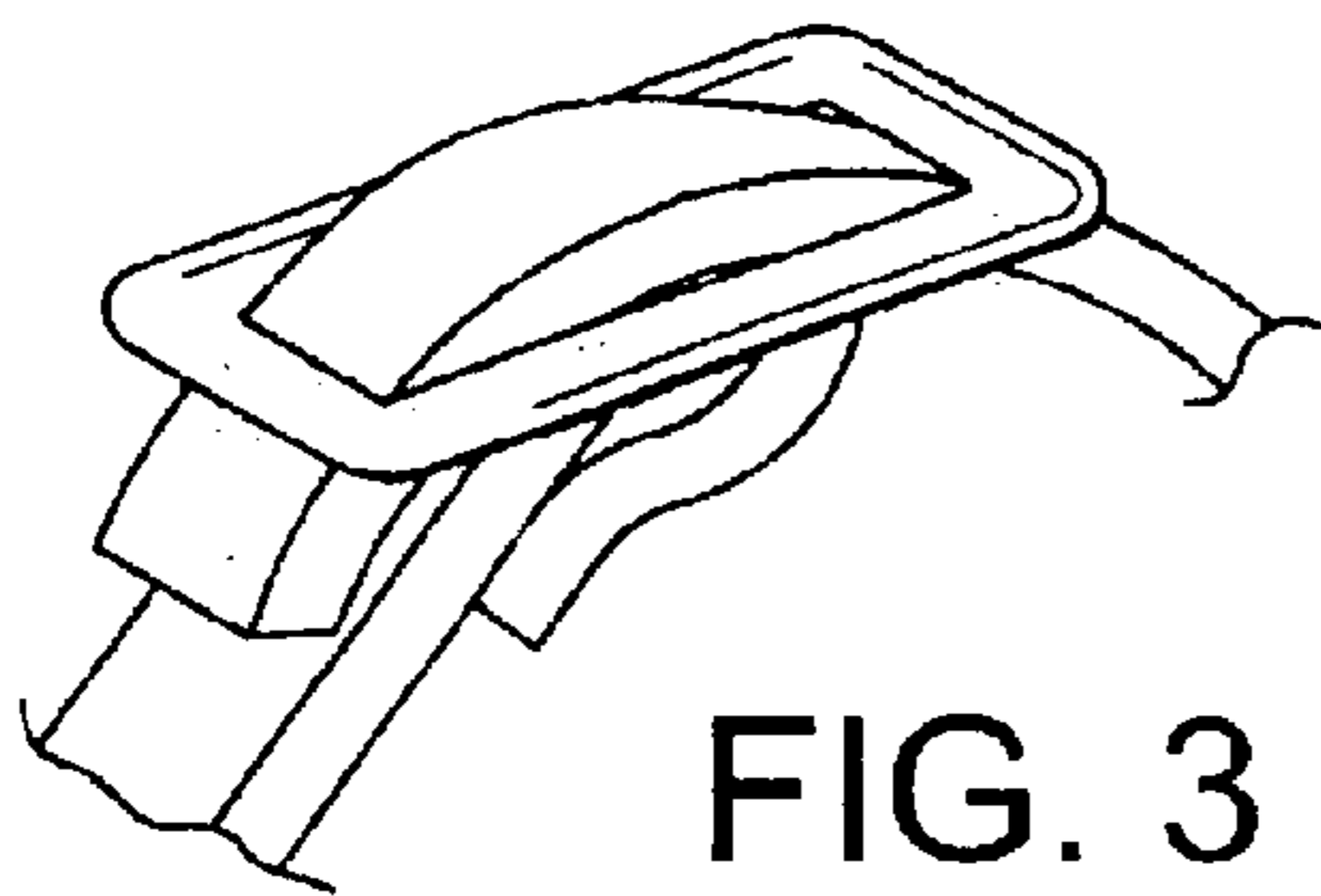

FIG. 3

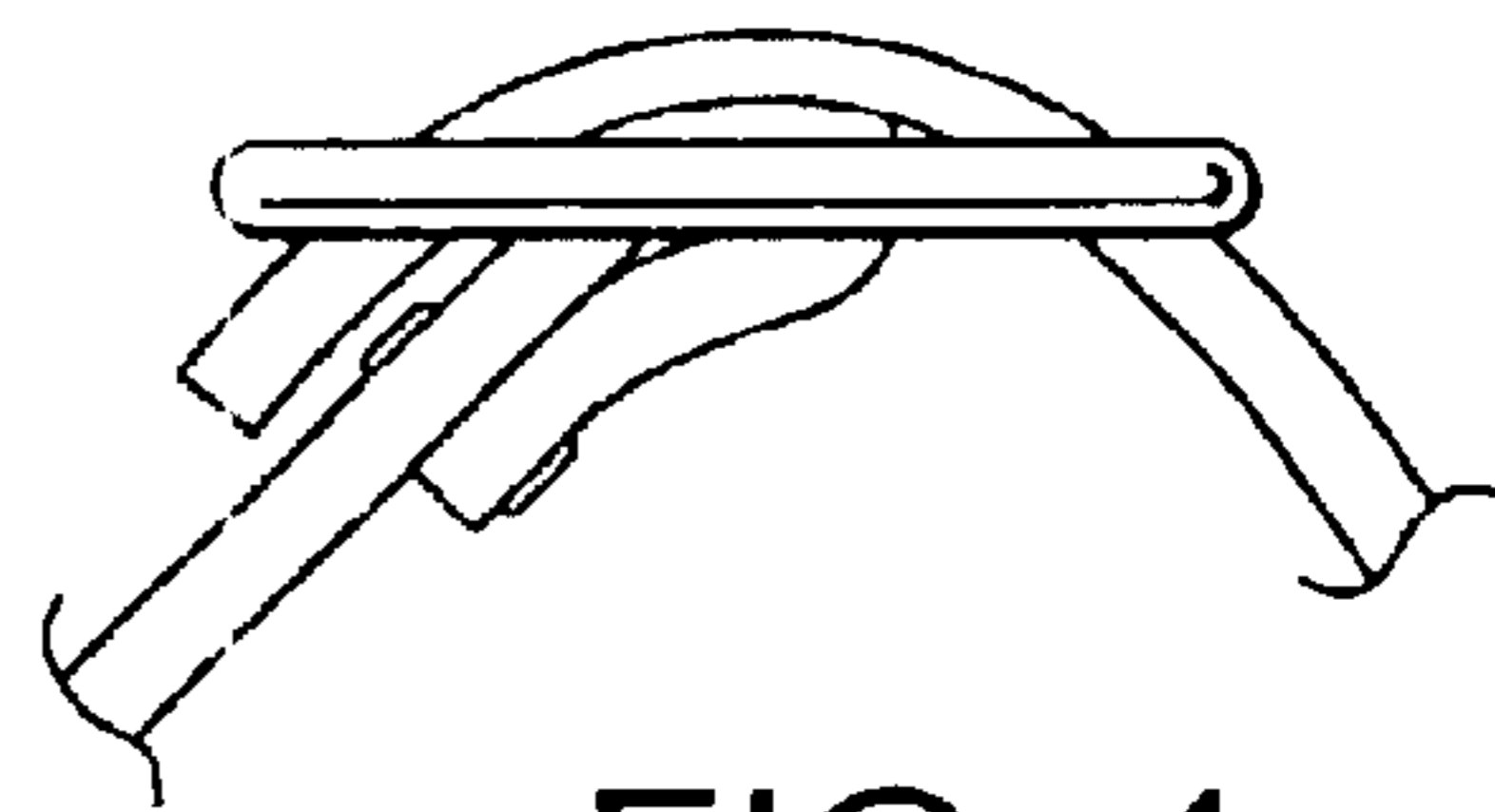

FIG. 4

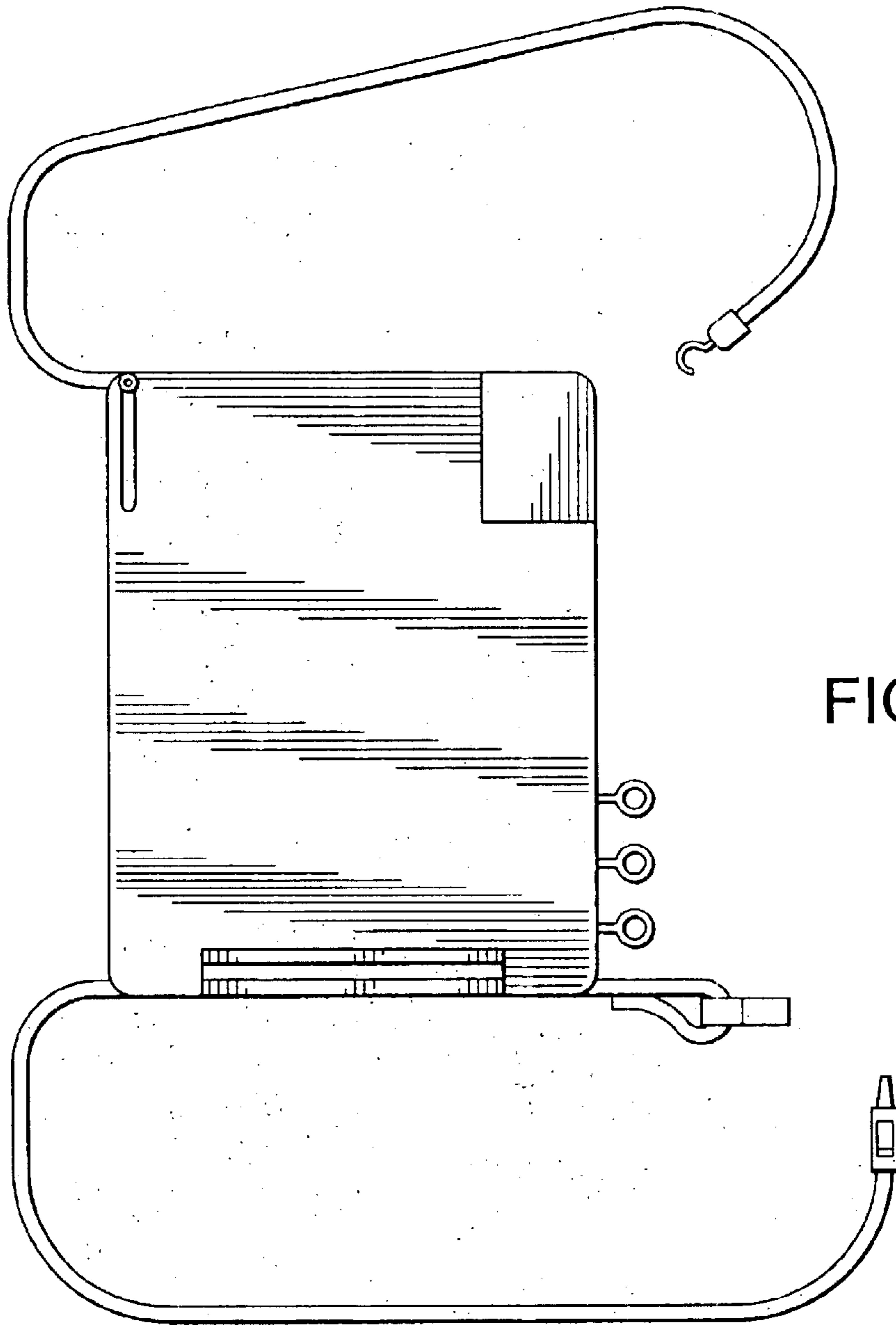

FIG. 5



FIG. 6



FIG. 7

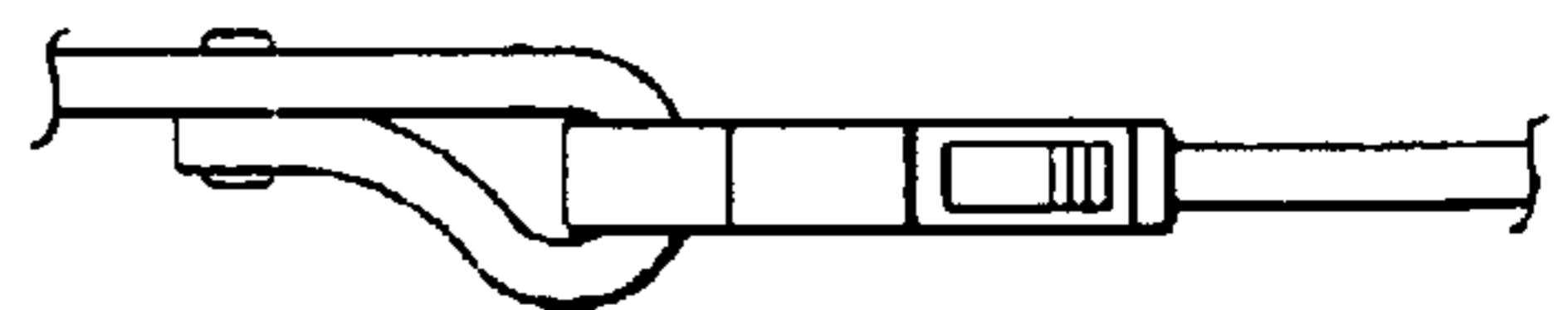

FIG. 8