



US00D490548S

(12) **United States Design Patent**
Maupin et al.

(10) **Patent No.:** **US D490,548 S**

(45) **Date of Patent:** **** May 25, 2004**

(54) **DECORATIVE HEADLAMP**

(75) Inventors: **Marvin C. Maupin**, Brownstown, IN
(US); **David D. Egly**, Columbus, IN
(US)

(73) Assignee: **Valeo Sylvania LLC**, Seymour, IN
(US)

(**) Term: **14 Years**

(21) Appl. No.: **29/180,637**

(22) Filed: **Apr. 25, 2003**

(51) **LOC (7) Cl.** **26-04**

(52) **U.S. Cl.** **D26/28**

(58) **Field of Search** D26/28-36; 362/61,
362/80, 81, 82, 83, 83.4, 267, 269, 275,
330-340

(56) **References Cited**

U.S. PATENT DOCUMENTS

D465,862 S * 11/2002 Lin D26/28

D472,655 S * 4/2003 Lin D26/28

D475,475 S * 6/2003 Lin D26/28

D477,678 S * 7/2003 Lin D26/28

* cited by examiner

Primary Examiner—Marcus A. Jackson

(74) *Attorney, Agent, or Firm*—William E. Meyer

(57) **CLAIM**

The ornamental design for a decorative headlamp, as shown and described.

DESCRIPTION

FIG. 1 is a perspective view of an decorative headlamp illustrating our new design;
FIG. 2 is a front view thereof;
FIG. 3 is a right side view thereof;
FIG. 4 is a left view thereof;
FIG. 5 is a top side view thereof;
FIG. 6 is a bottom view thereof; and,
FIG. 7 is a rear view thereof.

1 Claim, 6 Drawing Sheets

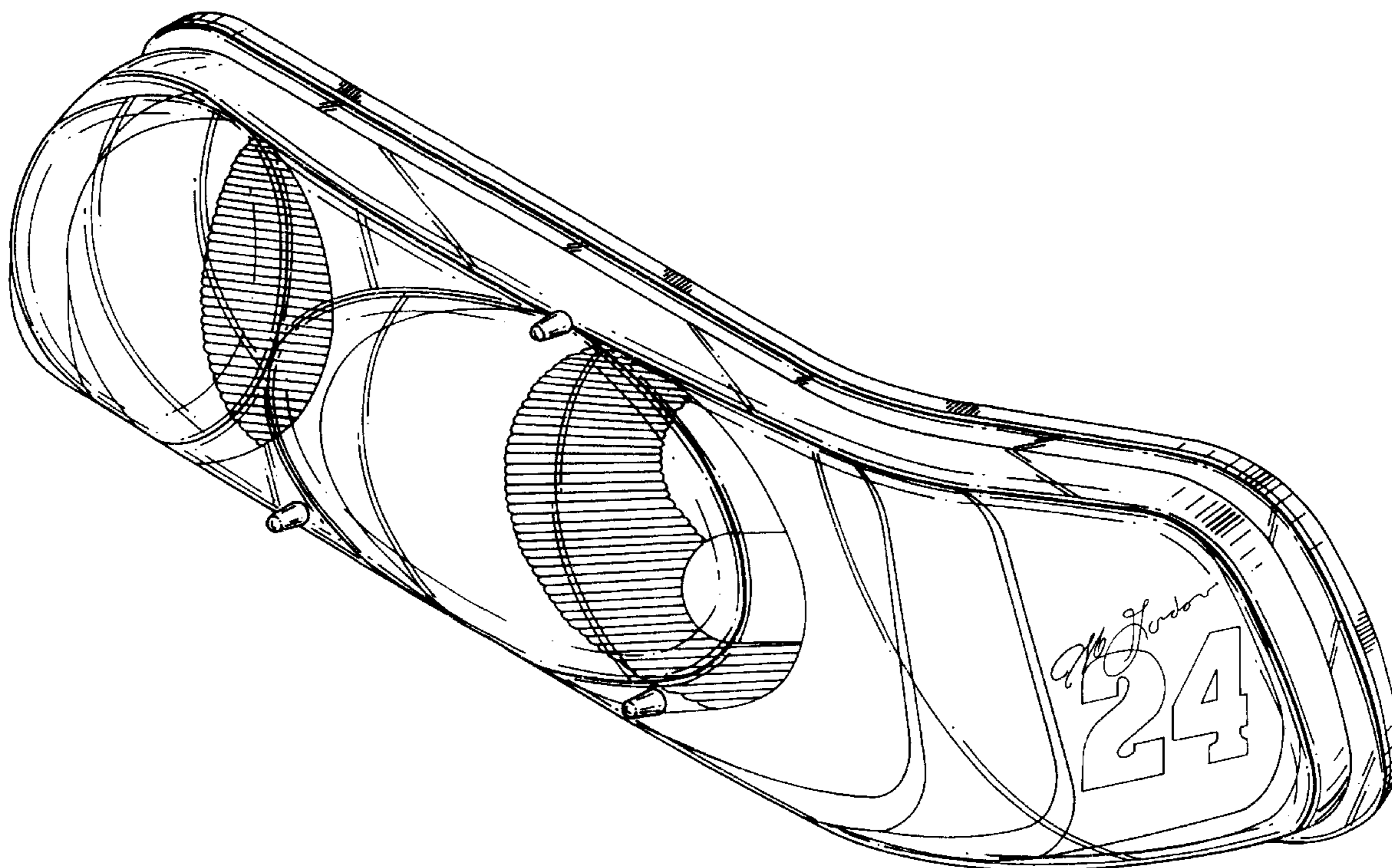

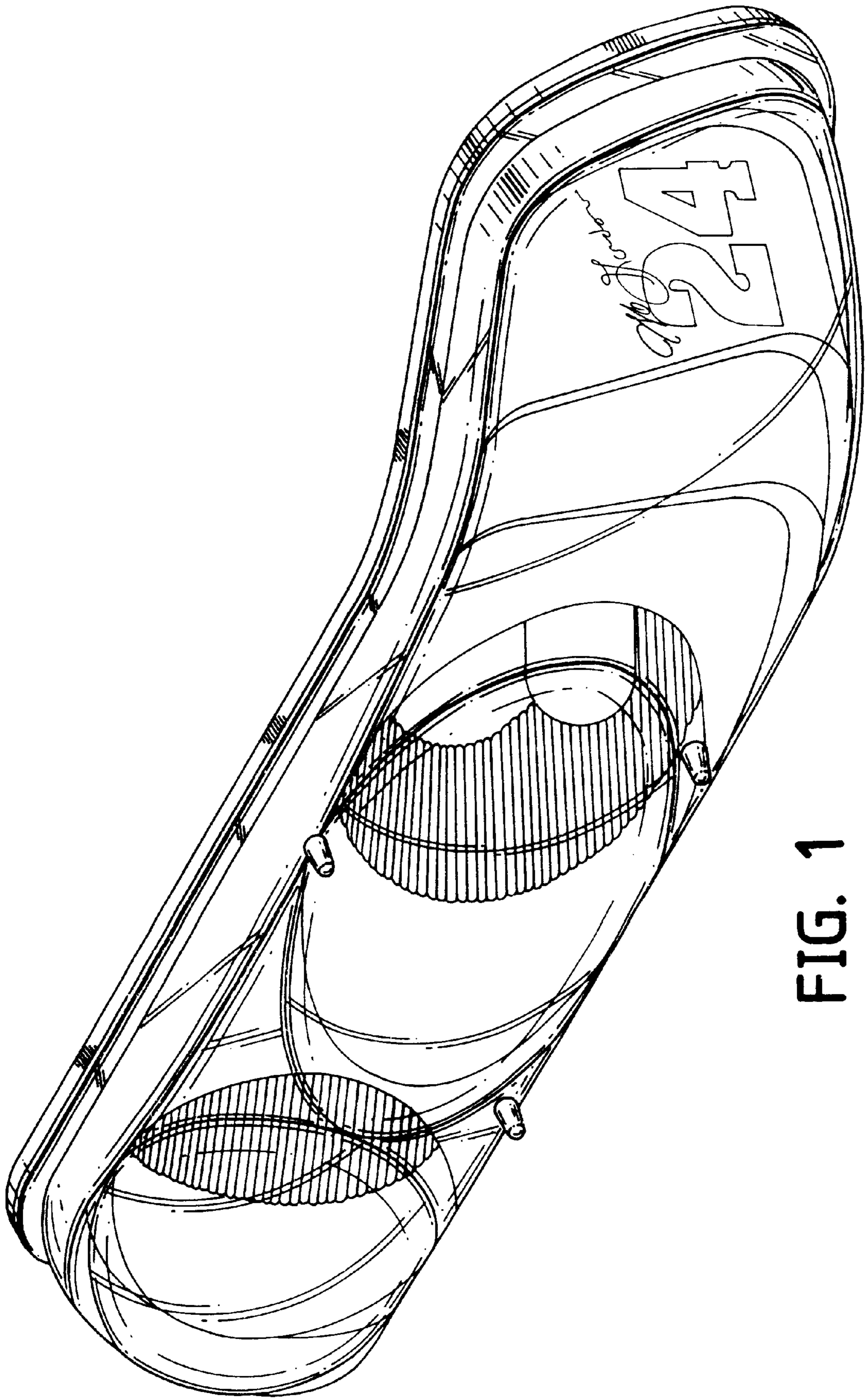

FIG. 1

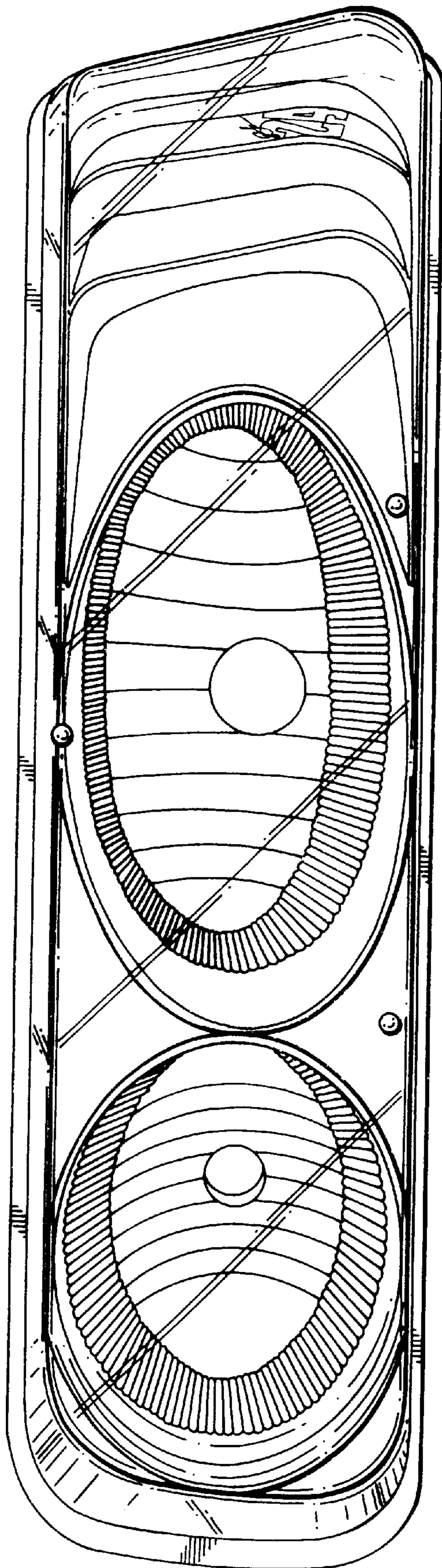

FIG. 2

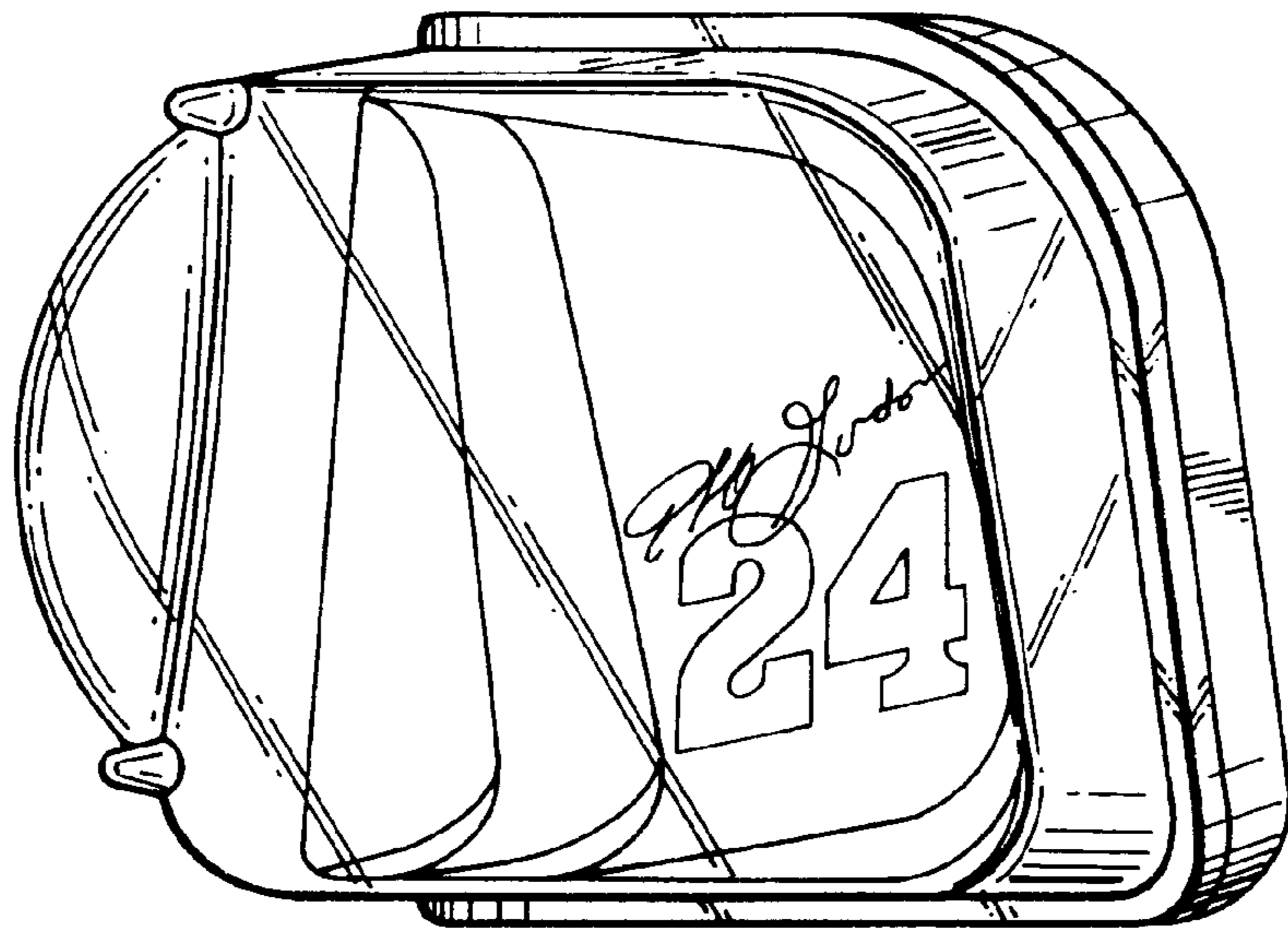

FIG. 3

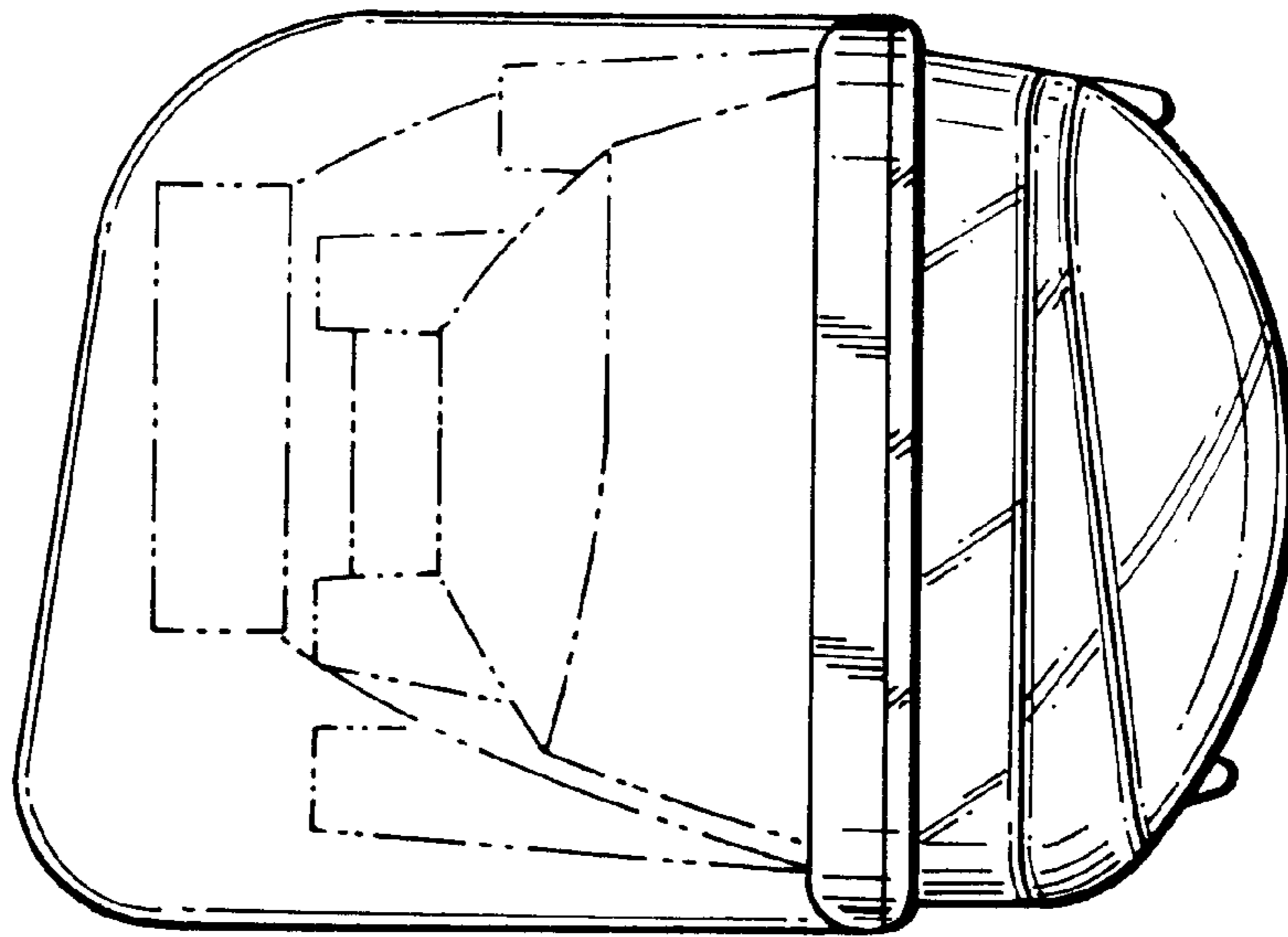

FIG. 4

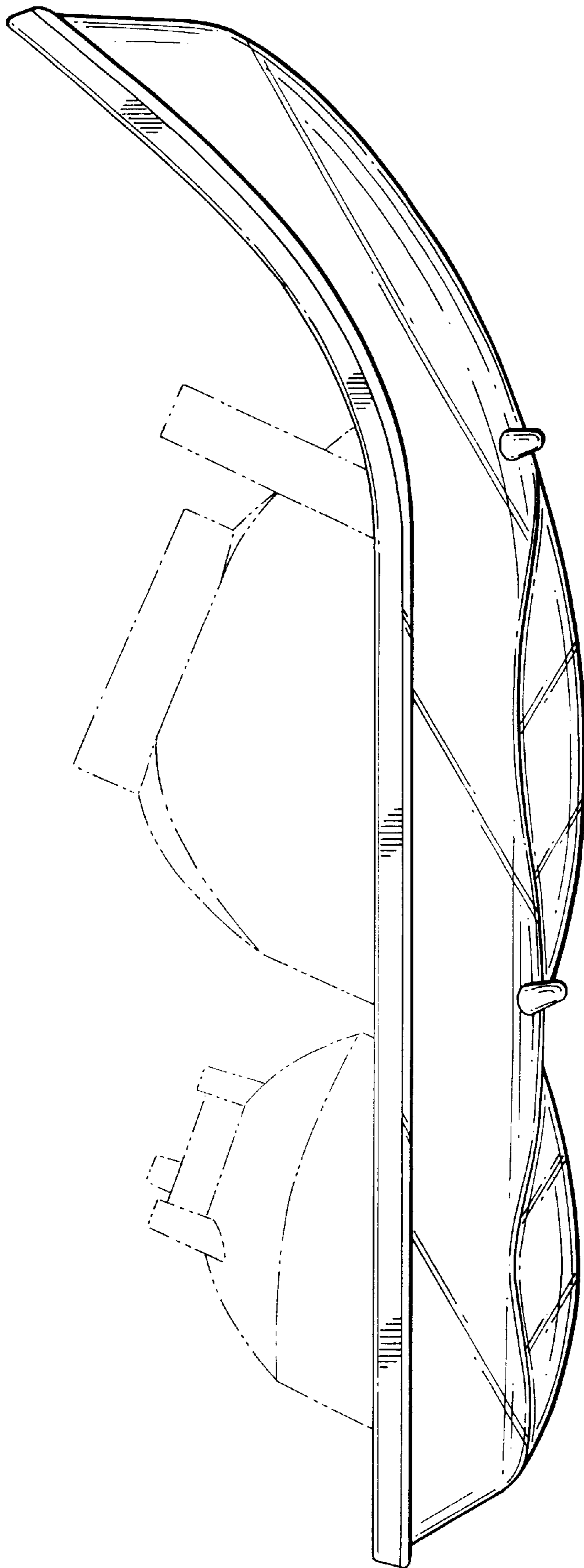

FIG. 5

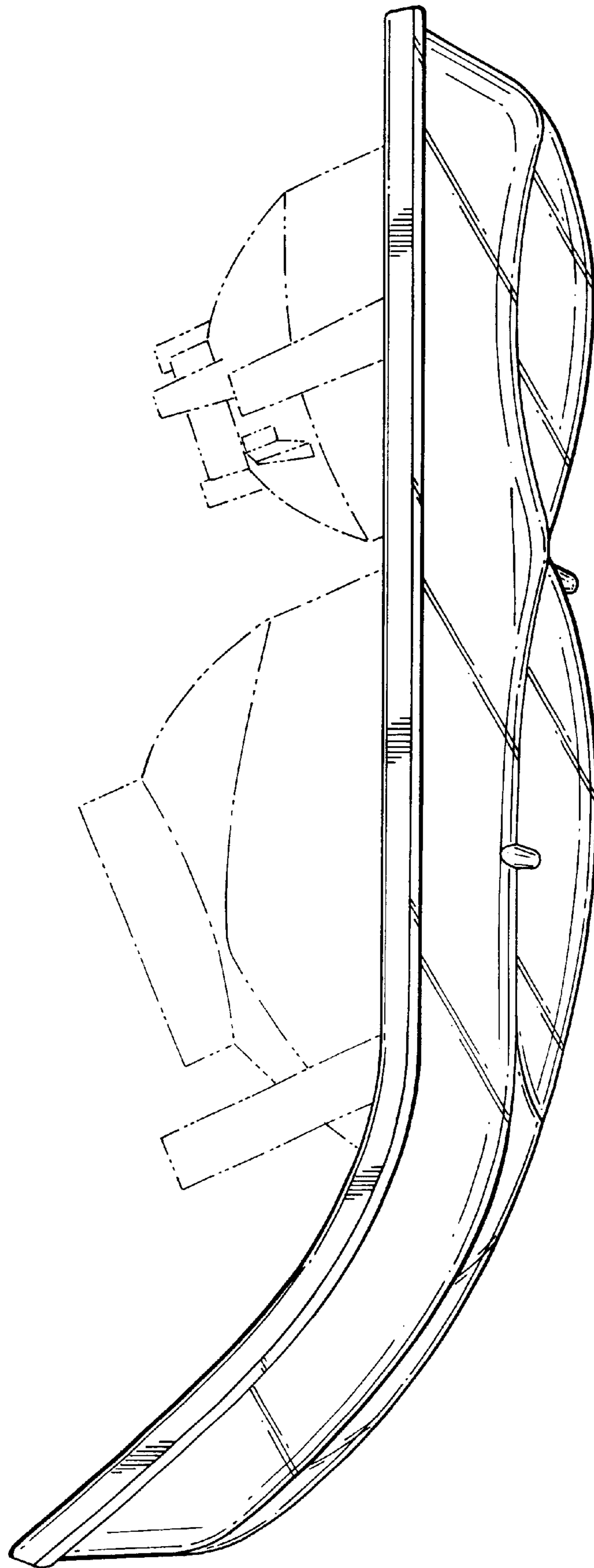

FIG. 6

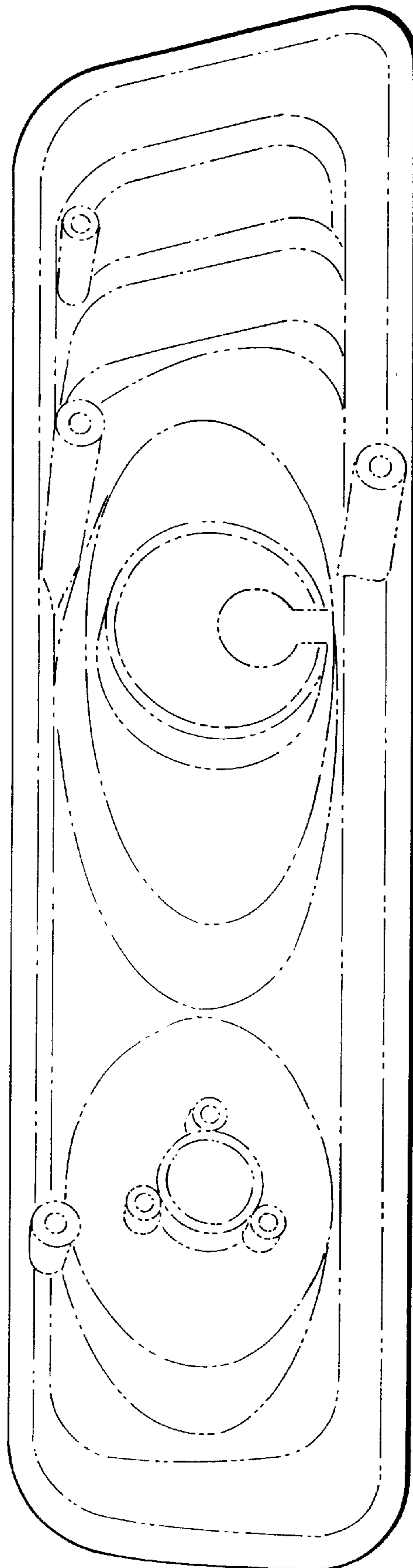

FIG. 7