



US00D490413S

(12) **United States Design Patent**
Arbisi

(10) **Patent No.:** **US D490,413 S**

(45) **Date of Patent:** **** May 25, 2004**

- (54) **FRONT COVER FOR A HANDSET**
- (75) Inventor: **Thomas Arbisi**, Newbury Park, CA (US)
- (73) Assignee: **Nokia Corporation**, Espoo (FI)
- (**) Term: **14 Years**
- (21) Appl. No.: **29/176,070**
- (22) Filed: **Feb. 19, 2003**
- (51) **LOC (7) Cl.** **14-03**
- (52) **U.S. Cl.** **D14/248**
- (58) **Field of Search** D14/137, 138, D14/218, 147-148, 247-248, 144, 341-347; 379/433.01-433.13, 419, 434, 428.01-428.04, 420.01-420.04, 440; 455/550.1-90.3; D21/517

- D459,324 S * 6/2002 Ahlgren D14/138
- D459,345 S 6/2002 Vuolteenaho et al.
- D460,445 S * 7/2002 Nguyen et al. D14/250
- D460,755 S * 7/2002 Cleary et al. D14/250
- D461,467 S * 8/2002 Ruohonen D14/248
- D462,345 S * 9/2002 Kim et al. D14/248
- 6,463,263 B1 * 10/2002 Feilner et al. 455/90
- D471,905 S * 3/2003 Langford D14/248
- D472,238 S * 3/2003 Dalby et al. D14/248
- D475,043 S * 5/2003 Lehtonen D14/248
- D475,703 S * 6/2003 Burns et al. D14/248
- D476,321 S * 6/2003 Pottie et al. D14/248
- D476,322 S * 6/2003 Arbisi et al. D14/248
- D476,650 S * 7/2003 Langford D14/248

FOREIGN PATENT DOCUMENTS

FI	21913	5/2001
FI	21973	6/2001
FI	21974	6/2001
FI	21975	6/2001
FI	22898	10/2002
FI	22899	10/2002
WO	WO-DM/060 034	6/2002
WO	WO-DM/062 301	1/2003

- (56) **References Cited**
- U.S. PATENT DOCUMENTS**
- D408,397 S * 4/1999 Renard D14/138
- D422,597 S * 4/2000 Finkbeiner D14/248
- D425,074 S * 5/2000 Frye et al. D14/248
- D428,001 S * 7/2000 Curtis D14/248
- D429,490 S * 8/2000 Collins et al. D14/248
- D429,491 S * 8/2000 Finkbeiner D14/248
- D434,016 S * 11/2000 Hunt D14/138
- D436,102 S * 1/2001 Wu D14/248
- D439,573 S * 3/2001 DeLeon D14/138
- D443,607 S * 6/2001 Kolinen D14/248
- D445,102 S * 7/2001 Lai D14/138
- D448,022 S * 9/2001 Higashi et al. D14/248
- D451,093 S * 11/2001 Tan et al. D14/248
- D451,914 S * 12/2001 Vuolteenaho et al. D14/248
- D452,235 S * 12/2001 Langford et al. D14/248
- D455,134 S * 4/2002 Kolinen D14/138
- D455,740 S * 4/2002 Salmi et al. D14/248
- D456,018 S * 4/2002 Lee D14/248
- D456,375 S 4/2002 Vuolteenaho et al.
- D456,376 S 4/2002 Vuolteenaho et al.
- D458,251 S * 6/2002 Vuolteenaho et al. D14/248

* cited by examiner

Primary Examiner—Jeffrey Asch
(74) *Attorney, Agent, or Firm*—Banner & Witcoff, Ltd.

(57) **CLAIM**

The ornamental design for a front cover for a handset, as shown and described.

DESCRIPTION

FIG. 1 is bottom plan view of a front cover for a handset showing my new design;
FIG. 2 is a right side view thereof;
FIG. 3 is a front view thereof;
FIG. 4 is a left side view thereof;
FIG. 5 is a top plan view thereof; and,
FIG. 6 is a perspective view thereof.

1 Claim, 2 Drawing Sheets

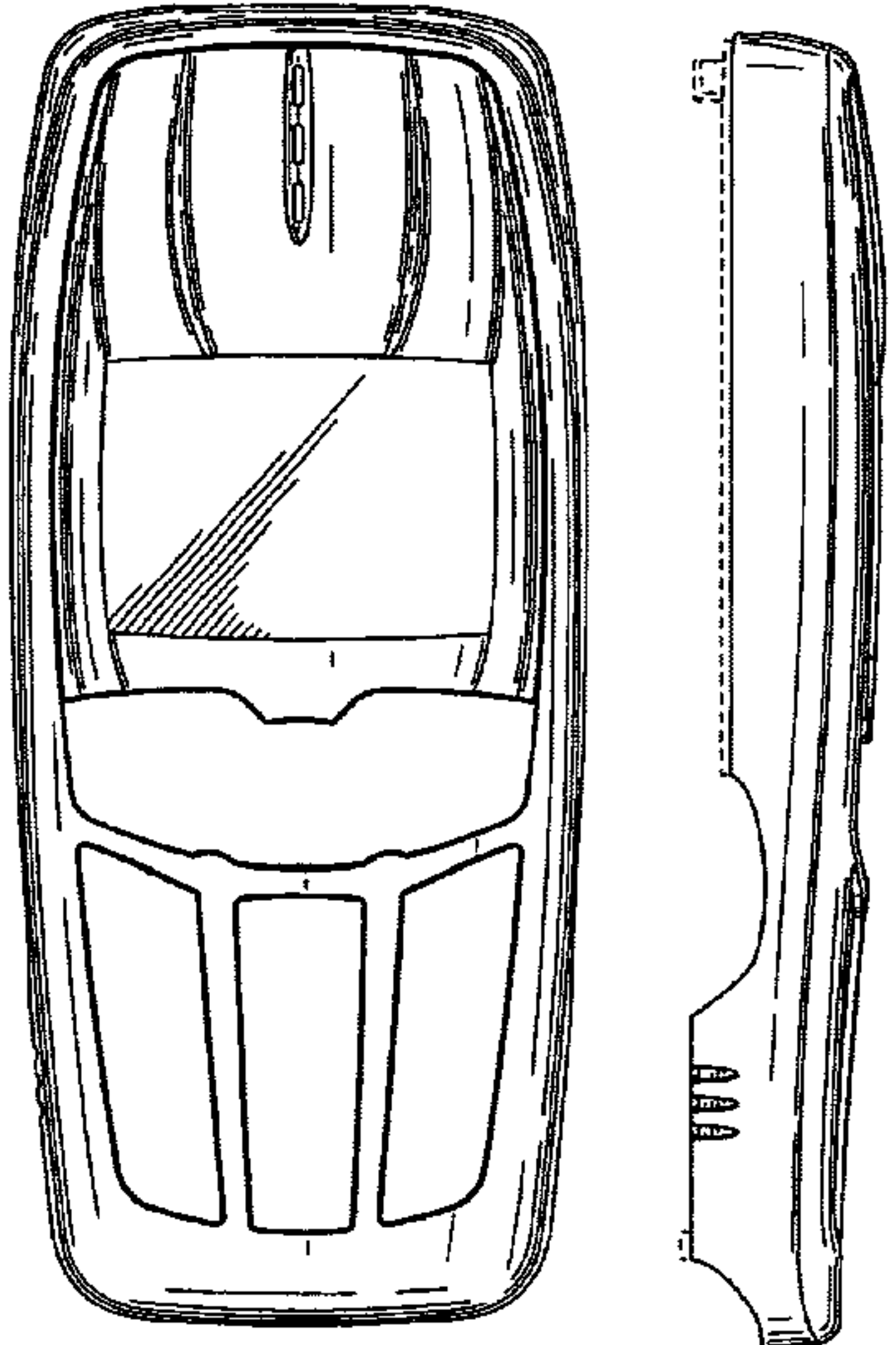

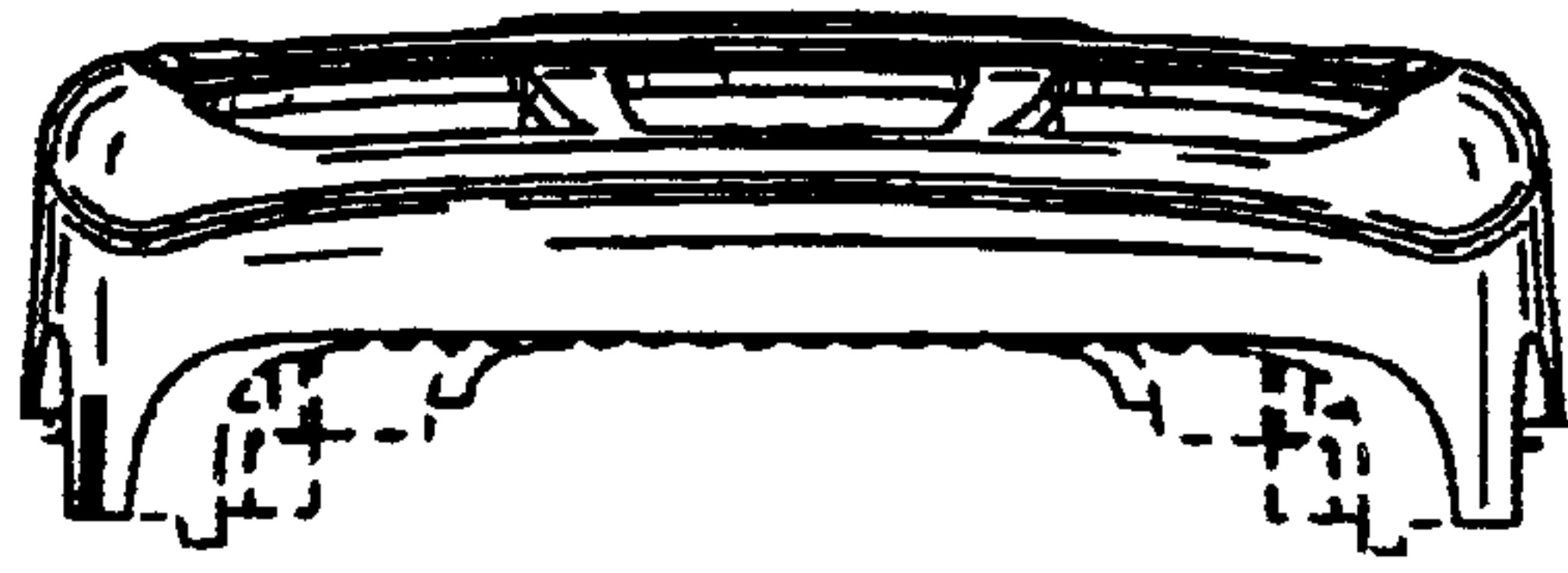

FIG. 1

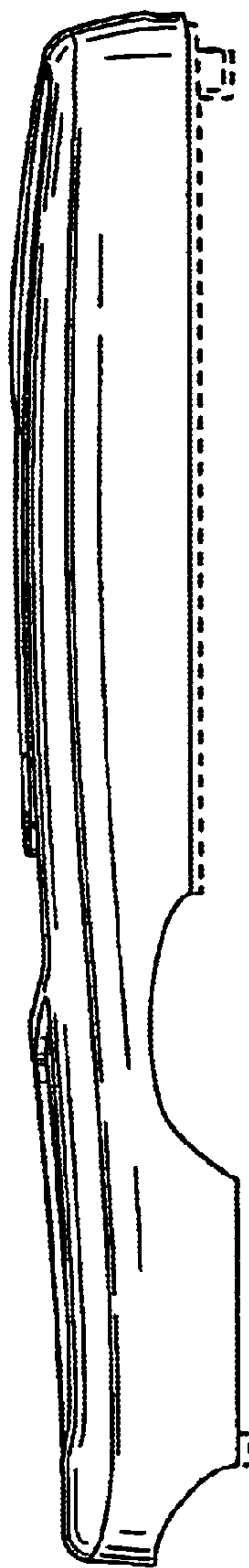

FIG. 2

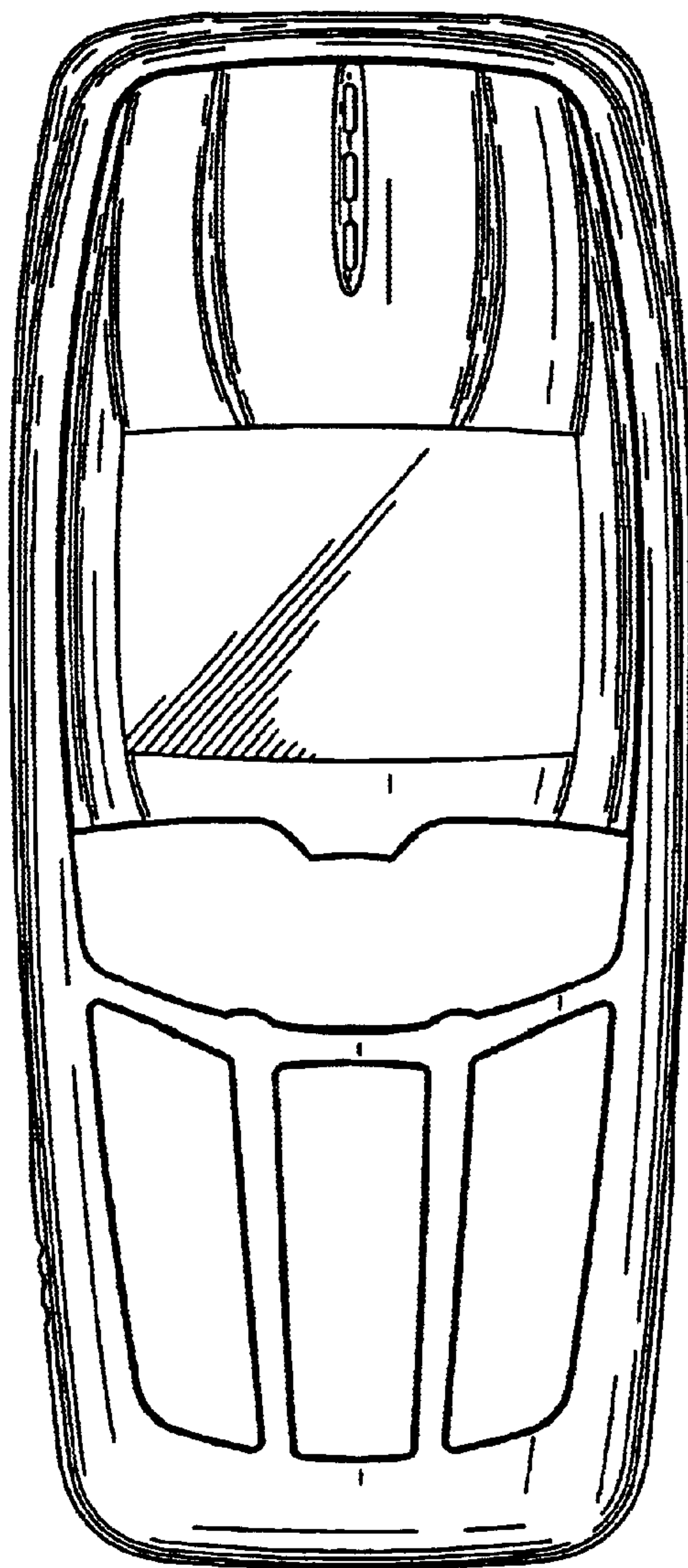

FIG. 3

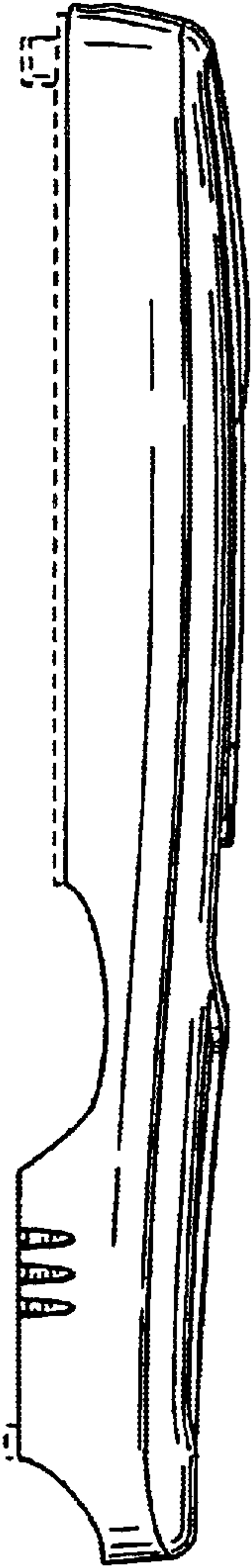

FIG. 4

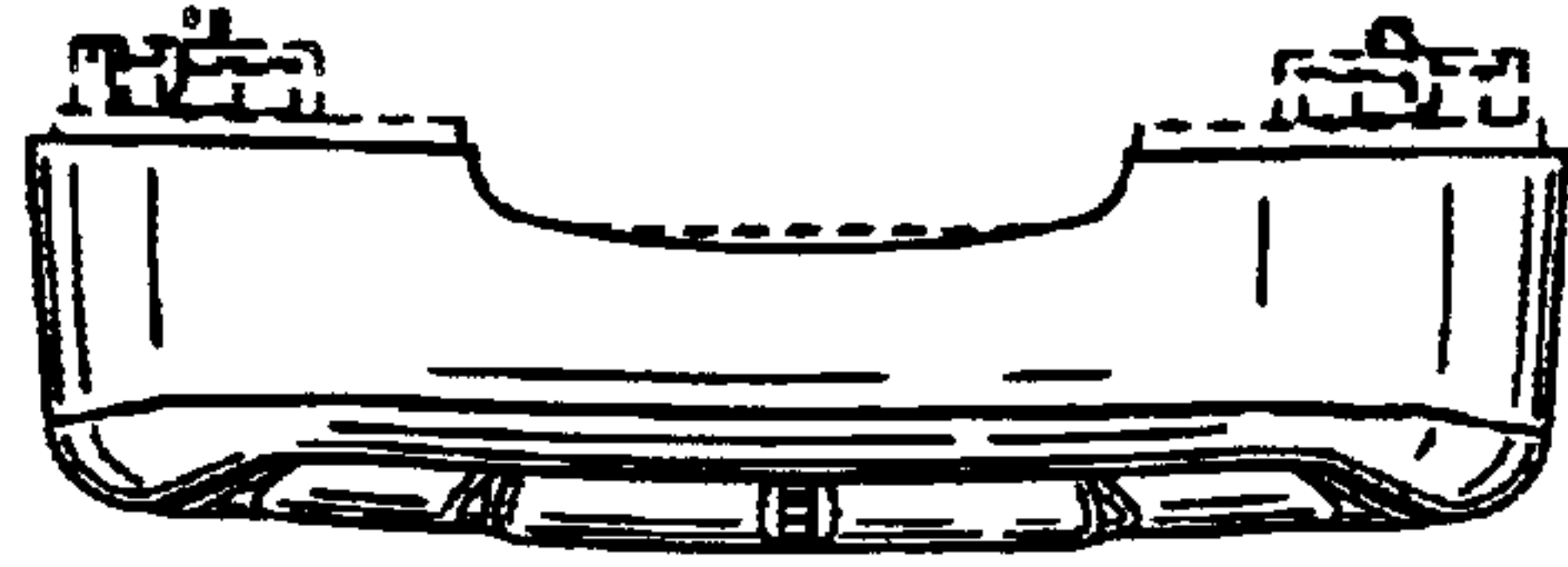

FIG. 5

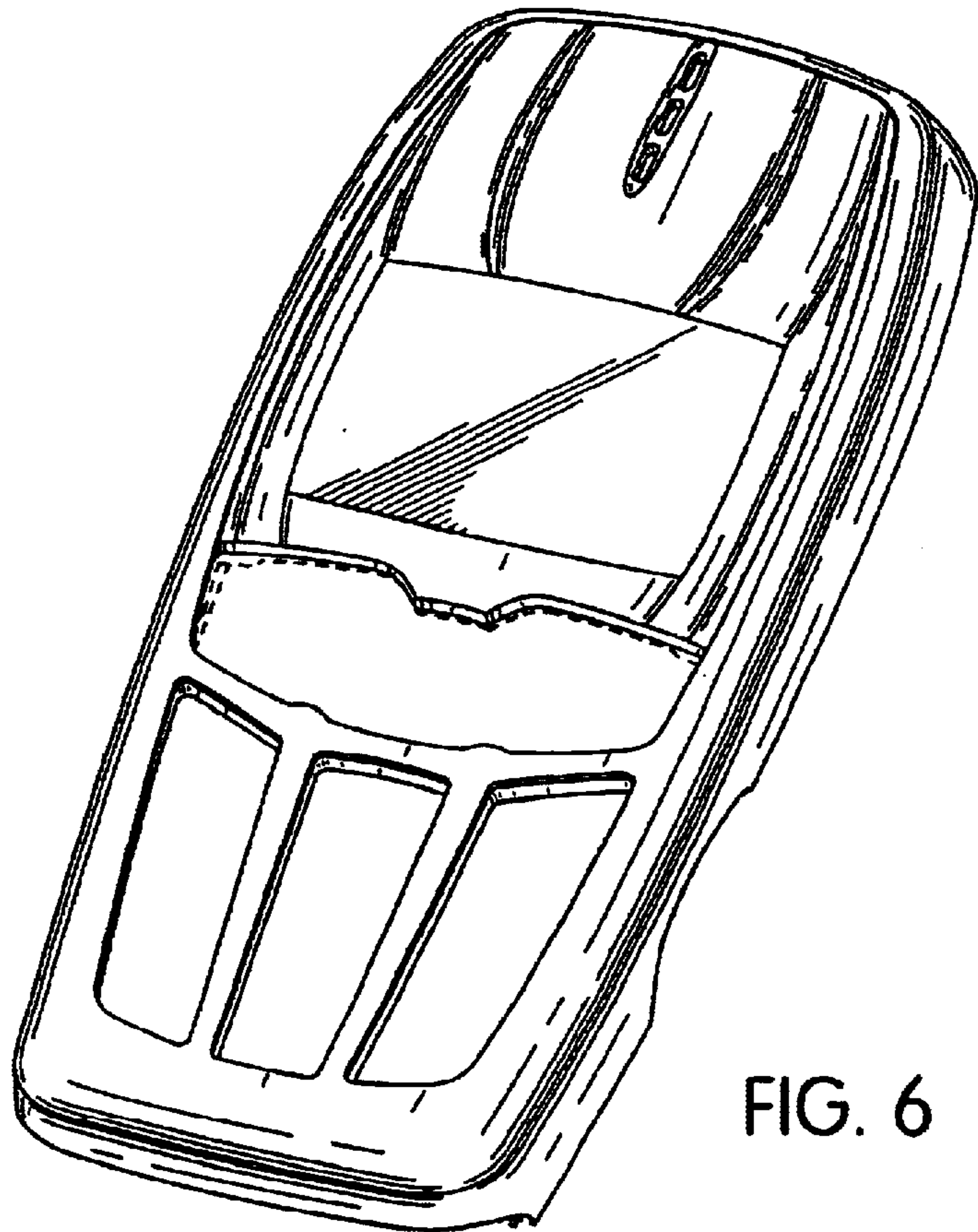

FIG. 6

UNITED STATES PATENT AND TRADEMARK OFFICE
CERTIFICATE OF CORRECTION

PATENT NO. : Des. 490,413 S
DATED : May 25, 2004
INVENTOR(S) : Thomas Arbisi

Page 1 of 1

It is certified that error appears in the above-identified patent and that said Letters Patent is hereby corrected as shown below:

Title page,
Item [57], **CLAIM,**
DESCRIPTION, the following sentence has been inserted:

-- The broken line showing of the internal surfaces and the extending tabs is for illustrative purposes only and forms no part of the claimed design. --

Signed and Sealed this

Fourteenth Day of December, 2004

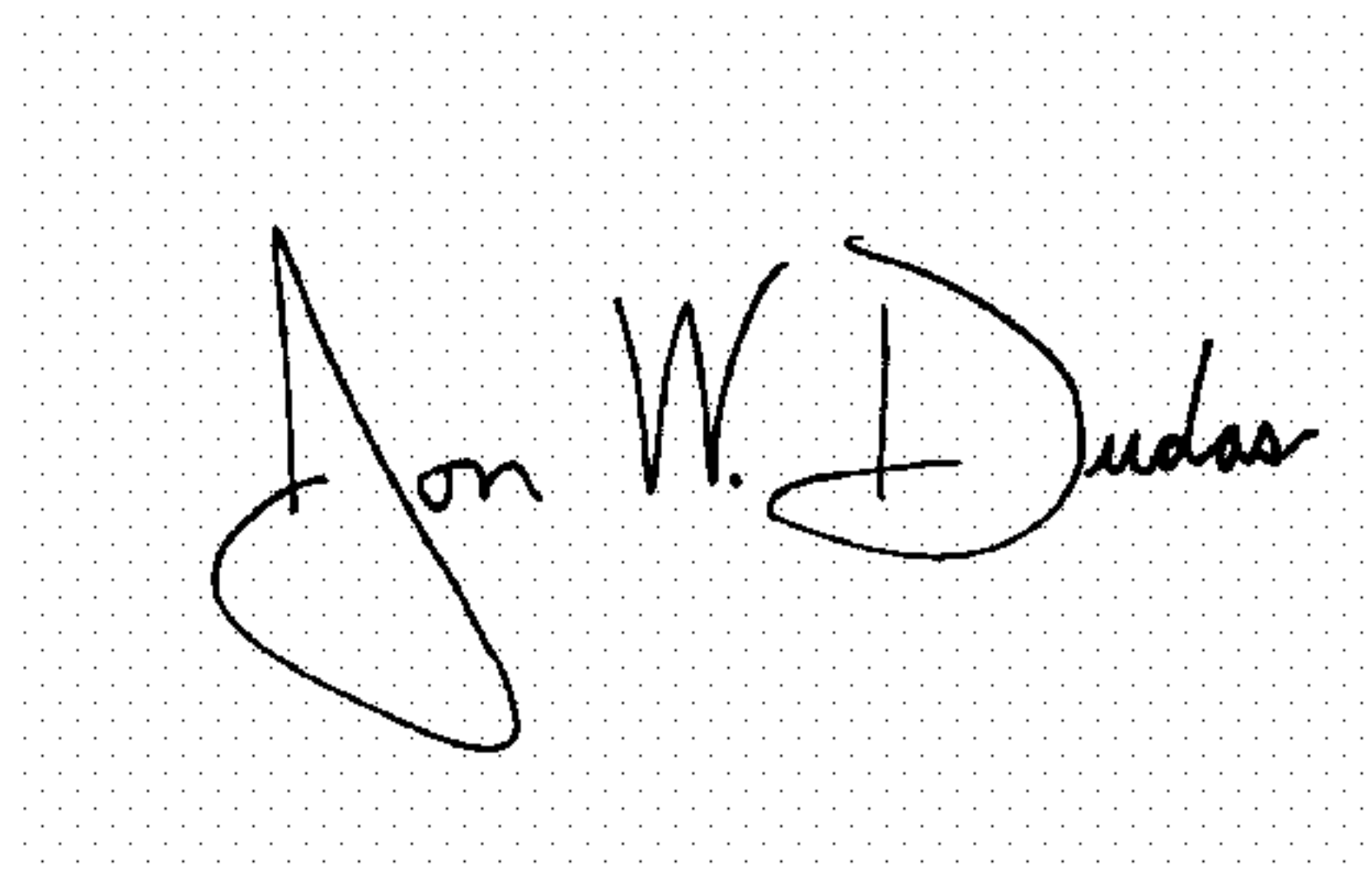
A handwritten signature in black ink on a light gray dotted background. The signature reads "Jon W. Dudas" in a cursive style.

JON W. DUDAS

Director of the United States Patent and Trademark Office