



US00D490411S

(12) **United States Design Patent**
Mehandjiysky

(10) **Patent No.:** **US D490,411 S**

(45) **Date of Patent:** **** May 25, 2004**

(54) **FRONT COVER FOR A HANDSET**

(75) **Inventor:** **Dimitre D. Mehandjiysky**, Woodland Hills, CA (US)

(73) **Assignee:** **Nokia Corporation**, Espoo (FI)

(**) **Term:** **14 Years**

(21) **Appl. No.:** **29/170,246**

(22) **Filed:** **Nov. 1, 2002**

(51) **LOC (7) Cl.** **14-03**

(52) **U.S. Cl.** **D14/248**

(58) **Field of Search** D14/137, 138,
D14/218, 147-148, 247-248, 144, 341-347;
379/433.01-433.13, 419, 434, 428.01-428.04,
420.01-420.04, 440; 455/550.1-90.3; D21/517

D453,150 S	*	1/2002	Murray	D14/138
D455,134 S	*	4/2002	Kolinen	D14/138
D455,726 S	*	4/2002	Kolinen	D14/138
D455,740 S	*	4/2002	Salmi et al.	D14/248
D456,018 S	*	4/2002	Lee	D14/248
D458,251 S	*	6/2002	Vuolteenaho et al.	D14/248
D459,324 S	*	6/2002	Ahlgren	D14/138
D460,755 S	*	7/2002	Cleary et al.	D14/250
D461,467 S	*	8/2002	Ruohonen	D14/248
D462,345 S	*	9/2002	Kim et al.	D14/248
D464,940 S	*	10/2002	Jung	D14/138
6,463,263 B1	*	10/2002	Feilner et al.	455/90
D471,905 S	*	3/2003	Langford	D14/248
D472,238 S	*	3/2003	Dalby et al.	D14/248
D475,043 S	*	5/2003	Lehtonen	D14/248
D475,703 S	*	6/2003	Burns et al.	D14/248
D475,704 S	*	6/2003	Arbisi	D14/248
D476,321 S	*	6/2003	Pottie et al.	D14/248
D476,322 S	*	6/2003	Arbisi et al.	D14/248
D476,650 S	*	7/2003	Langford	D14/248
2003/0038787 A1	*	2/2003	Nishiyama		

(56) **References Cited**

U.S. PATENT DOCUMENTS

D407,720 S	*	4/1999	Nagano et al.	D14/138
D408,397 S	*	4/1999	Renard	D14/138
D420,680 S	*	2/2000	Curtis	D14/248
D422,597 S	*	4/2000	Finkbeiner	D14/248
D425,074 S	*	5/2000	Frye et al.	D14/248
D426,531 S	*	6/2000	Chikaraishi et al.	D14/138
D428,001 S	*	7/2000	Curtis	D14/248
D429,490 S	*	8/2000	Collins et al.	D14/248
D429,491 S	*	8/2000	Finkbeiner	D14/248
D430,127 S	*	8/2000	Collins et al.	D14/138
D434,016 S	*	11/2000	Hunt	D14/138
D435,529 S	*	12/2000	Lai	D14/138
D439,573 S	*	3/2001	DeLeon	D14/138
D443,600 S	*	6/2001	Ogawa	D14/138
D443,607 S	*	6/2001	Kolinen	D14/248
D446,509 S	*	8/2001	Chiu	D14/138
D448,022 S	*	9/2001	Higashi et al.	D14/248
D449,597 S	*	10/2001	Tan et al.	D14/248
D451,093 S	*	11/2001	Tan et al.	D14/248
D451,914 S	*	12/2001	Vuolteenaho et al.	D14/248
D452,235 S	*	12/2001	Langford et al.	D14/248

FOREIGN PATENT DOCUMENTS

FI 22887 10/2002

* cited by examiner

Primary Examiner—Jeffrey Asch

(74) *Attorney, Agent, or Firm*—Banner & Witcoff, Ltd.

(57) **CLAIM**

I claim the ornamental design for a front cover for a handset, as shown and described.

DESCRIPTION

FIG. 1 is a bottom plan view of the front cover for a handset; FIG. 2 is a right side view thereof; FIG. 3 is front view thereof; FIG. 4 is a left side view thereof; FIG. 5 is a top plan view thereof; and, FIG. 6 is a perspective front view thereof.

1 Claim, 6 Drawing Sheets

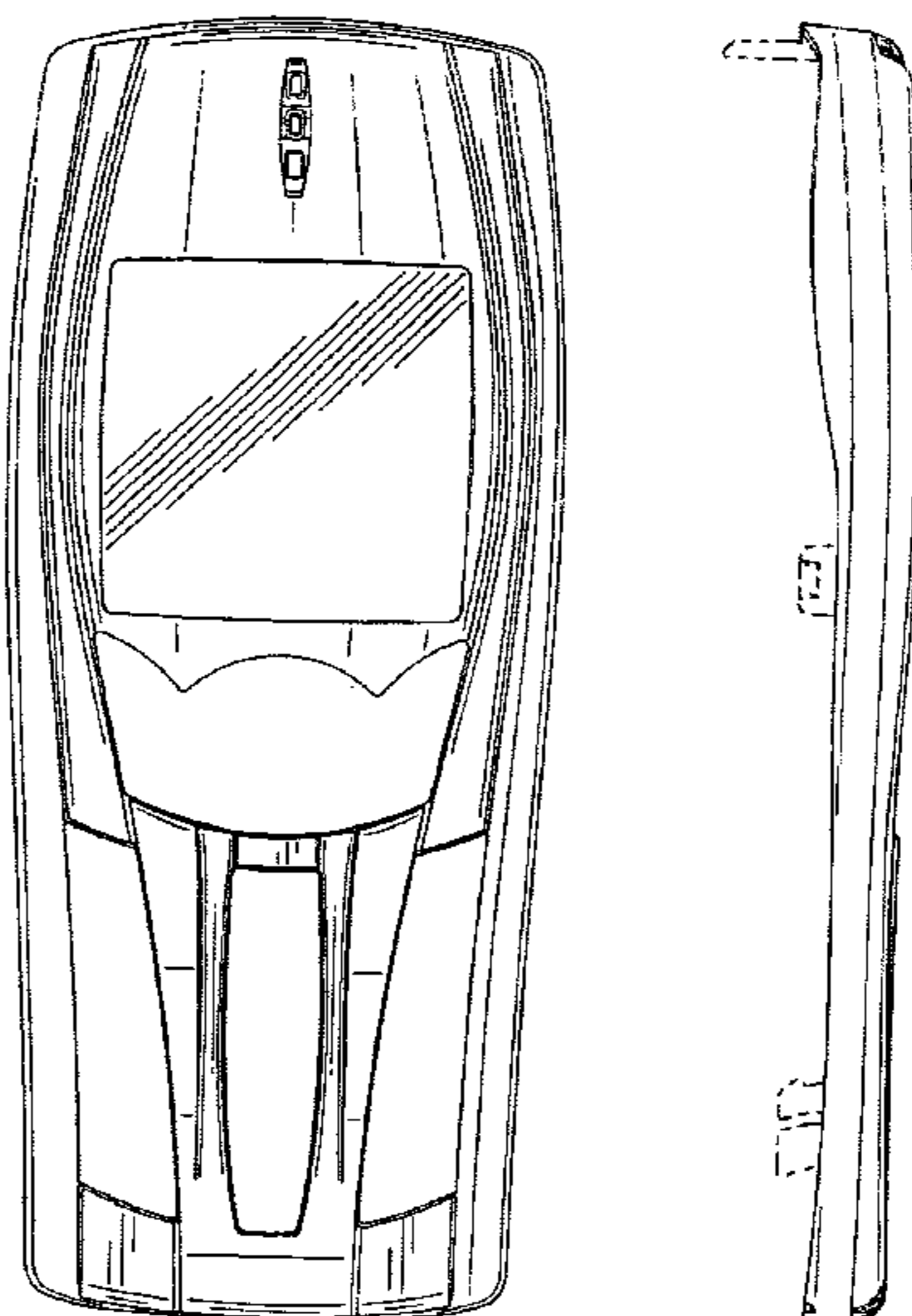

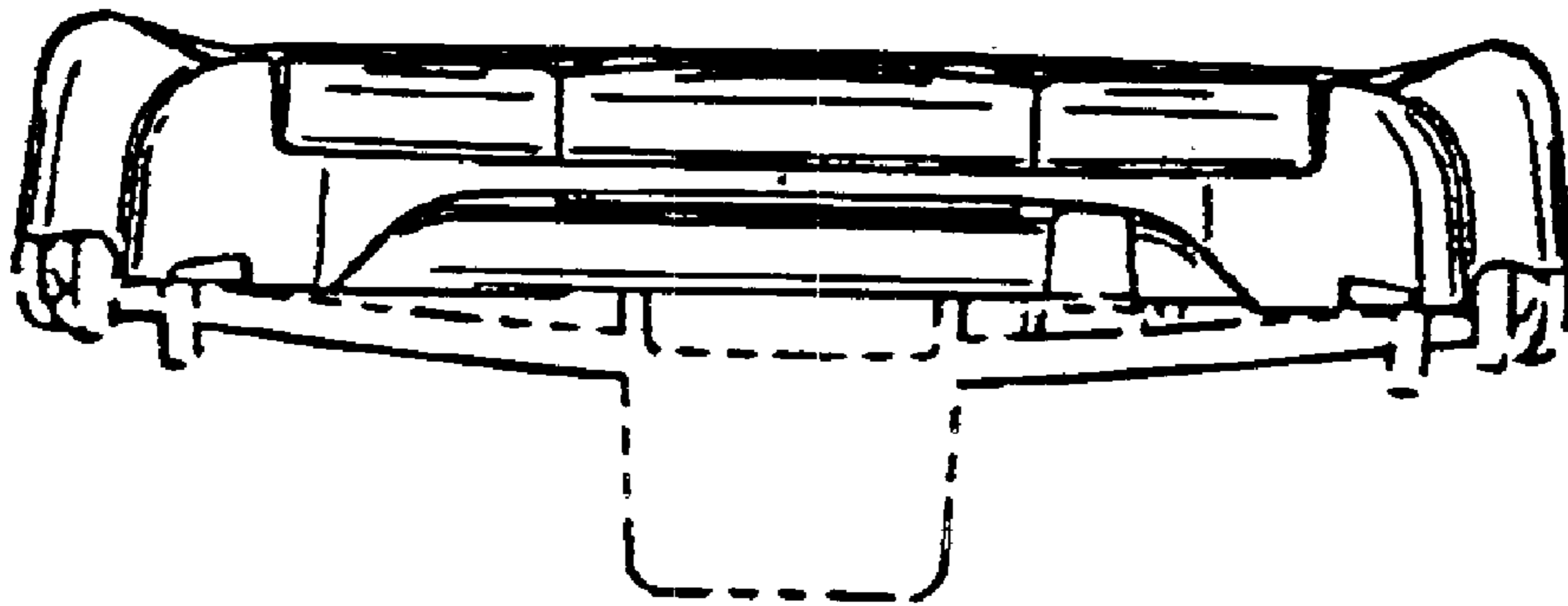

FIG. 1

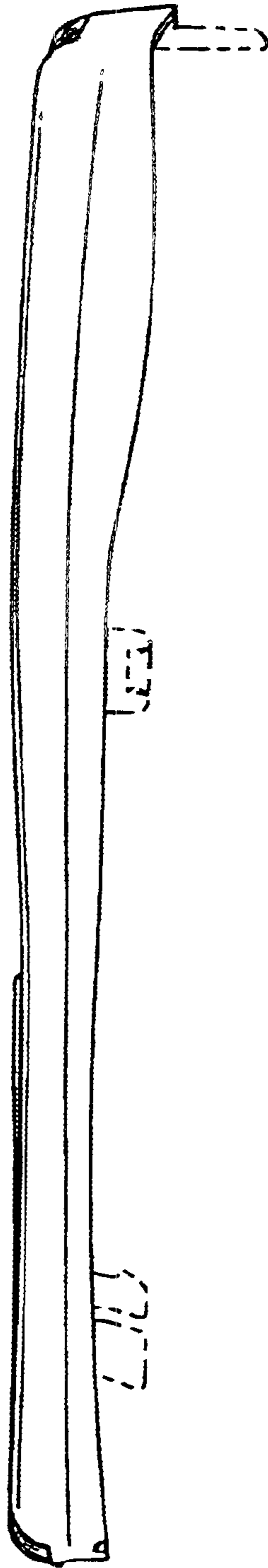

FIG. 2

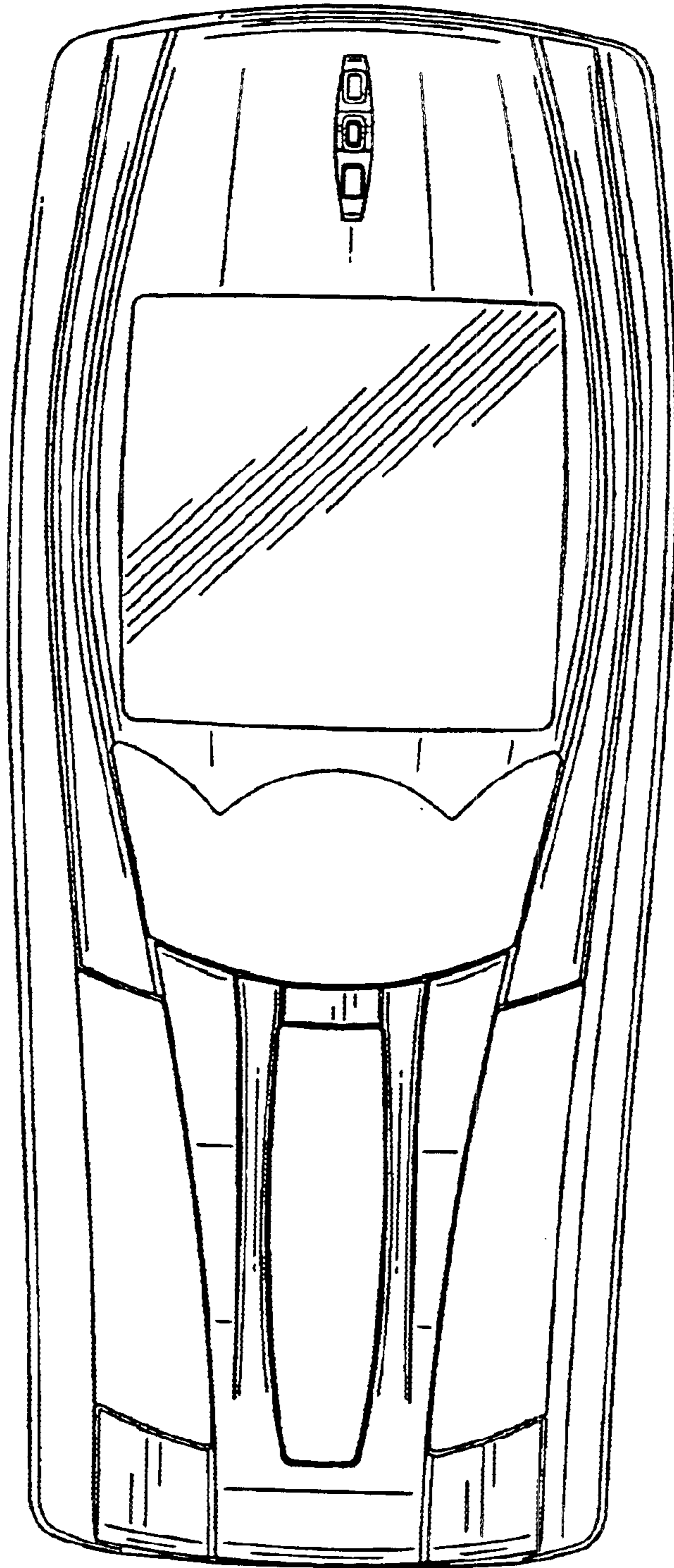

FIG. 3

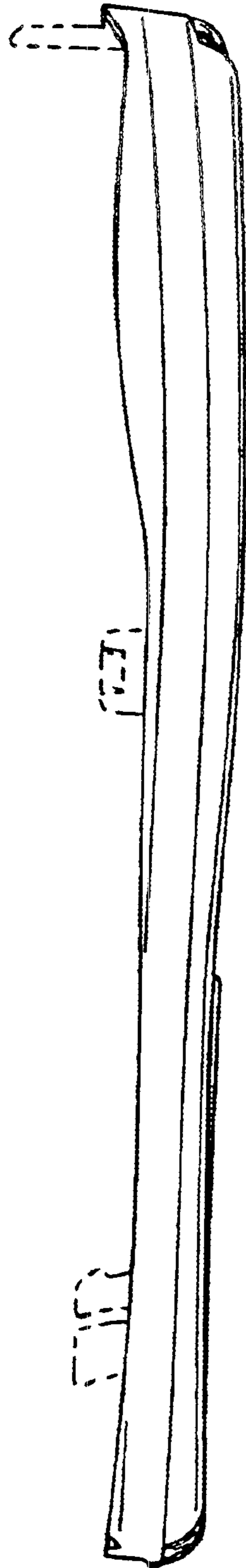

FIG. 4

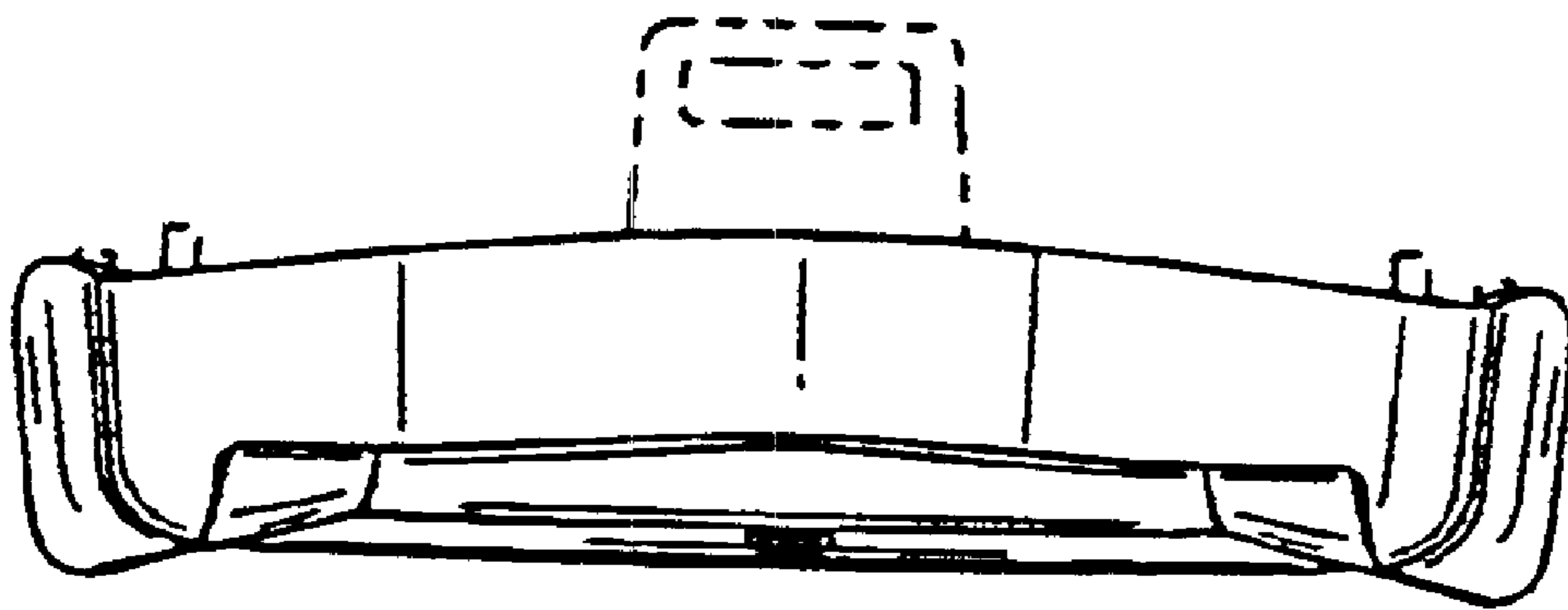

FIG. 5

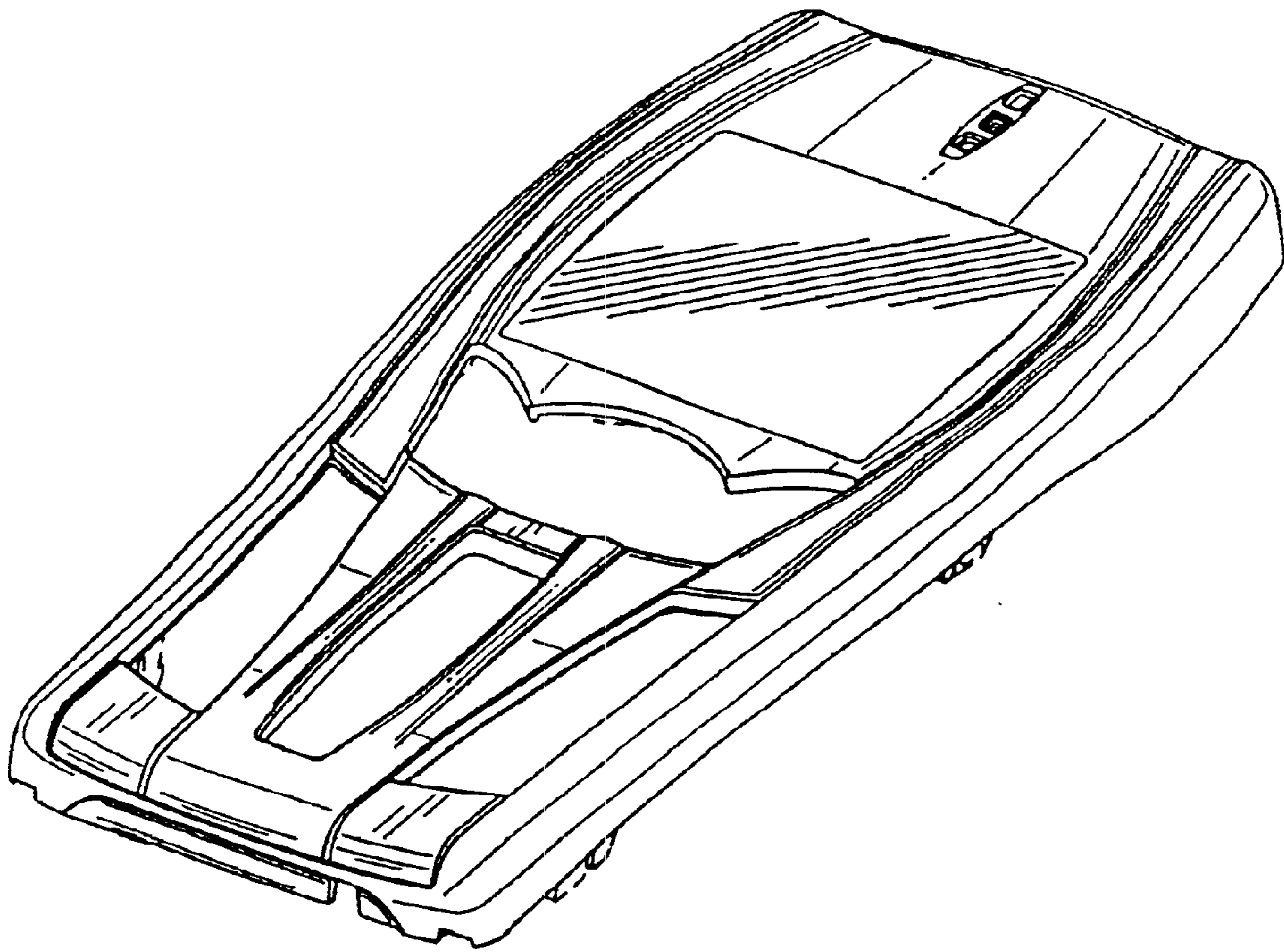

FIG. 6

UNITED STATES PATENT AND TRADEMARK OFFICE
CERTIFICATE OF CORRECTION

PATENT NO. : Des. 490,411 S
DATED : May 25, 2004
INVENTOR(S) : Dimitre D. Mehandjiysky

Page 1 of 1

It is certified that error appears in the above-identified patent and that said Letters Patent is hereby corrected as shown below:

Title page,

Item [57], **DESCRIPTION**, the following sentence has been inserted:

-- The broken line showing of the internal surfaces and the extending tabs is for illustrative purposes only and forms no part of the claimed design. --

Signed and Sealed this

Eighteenth Day of January, 2005

A handwritten signature in black ink that reads "Jon W. Dudas". The signature is written in a cursive style with a large, stylized initial "J" and "D".

JON W. DUDAS
Director of the United States Patent and Trademark Office