



US00D490409S

(12) **United States Design Patent**
Mehandjiysky

(10) **Patent No.:** **US D490,409 S**

(45) **Date of Patent:** **** May 25, 2004**

(54) **BACK COVER FOR A HANDSET**

(75) Inventor: **Dimitre Mehandjiysky**, Woodland Hills, CA (US)

(73) Assignee: **Nokia Corporation**, Espoo (FI)

(**) Term: **14 Years**

(21) Appl. No.: **29/170,210**

(22) Filed: **Nov. 1, 2002**

(51) **LOC (7) Cl.** **14-03**

(52) **U.S. Cl.** **D14/248**

(58) **Field of Search** D14/137, 240,
D14/138, 218, 147-148, 247-248, 144,
191, 341-347; 379/433.01-433.13, 419,
434, 428.01-428.04, 420.01-420.04, 440;
455/550-575, 90; D21/517, 329, 331, 333;
D13/103, 119, 168

(56) **References Cited**

U.S. PATENT DOCUMENTS

D388,783 S	*	1/1998	Harden et al.	D14/138
D390,509 S	*	2/1998	Antzinas et al.	D14/138
D410,623 S	*	6/1999	Kolinen	D13/103
D410,892 S	*	6/1999	Prior	D13/103
D412,484 S	*	8/1999	Salmi	D13/103
D417,428 S	*	12/1999	Kolinen et al.	D13/103
D421,004 S	*	2/2000	Curtis	D14/138
D422,282 S	*	4/2000	Curtis	D14/248
D425,906 S	*	5/2000	Finkbeiner	D14/248
D426,531 S	*	6/2000	Chikaraishi et al.	D14/138
D429,708 S	*	8/2000	Kodera et al.	D14/138
D434,016 S	*	11/2000	Hunt	D14/138
D434,410 S	*	11/2000	Frye et al.	D14/248
D439,573 S	*	3/2001	DeLeon	D14/138
D447,462 S	*	9/2001	Kosiba	D13/103
D448,366 S	*	9/2001	Youngers et al.	D14/240
D450,315 S	*	11/2001	Thimaporn	D14/248
D454,850 S	*	3/2002	Salmi et al.	D14/138
D454,868 S	*	3/2002	Vuolteenaho et al.	D14/248

D455,412 S	*	4/2002	Vuolteenaho et al.	D14/138
D455,413 S	*	4/2002	Lee	D14/138
D458,596 S	*	6/2002	Yin et al.	D14/138
D458,912 S	*	6/2002	DeLeon	D14/138
D458,913 S	*	6/2002	Suzuki et al.	D14/138
D459,325 S	*	6/2002	Nakahara	D14/138
D460,057 S	*	7/2002	Hunt	D14/138
D460,944 S	*	7/2002	Ahlgren	D13/119
D465,486 S	*	11/2002	Lee	D14/341
D474,166 S	*	5/2003	Burns et al.	D14/138
2002/0002059 A1	*	1/2002	Johnson	

FOREIGN PATENT DOCUMENTS

FI 22887 10/2002

* cited by examiner

Primary Examiner—Jeffrey Asch

(74) *Attorney, Agent, or Firm*—Banner & Witcoff, Ltd.

(57) **CLAIM**

I claim the ornamental design for a back cover for a handset, as shown and described.

DESCRIPTION

FIG. 1 is a bottom plan view of the back cover for a handset; FIG. 2 is a right side view thereof; FIG. 3 is a front view thereof; FIG. 4 is a left side view thereof; FIG. 5 is a top plan view thereof; FIG. 6 is a perspective front view thereof; FIG. 7 is a bottom plan view of a second embodiment of the front cover for a handset of FIG. 1; FIG. 8 is a left side view of thereof; FIG. 9 is a front view thereof; FIG. 10 is a right side view thereof; FIG. 11 is a top plan view thereof; and, FIG. 12 is a perspective view thereof. The broken line showings are for illustrative purposes only and form no part of the claimed design.

1 Claim, 12 Drawing Sheets

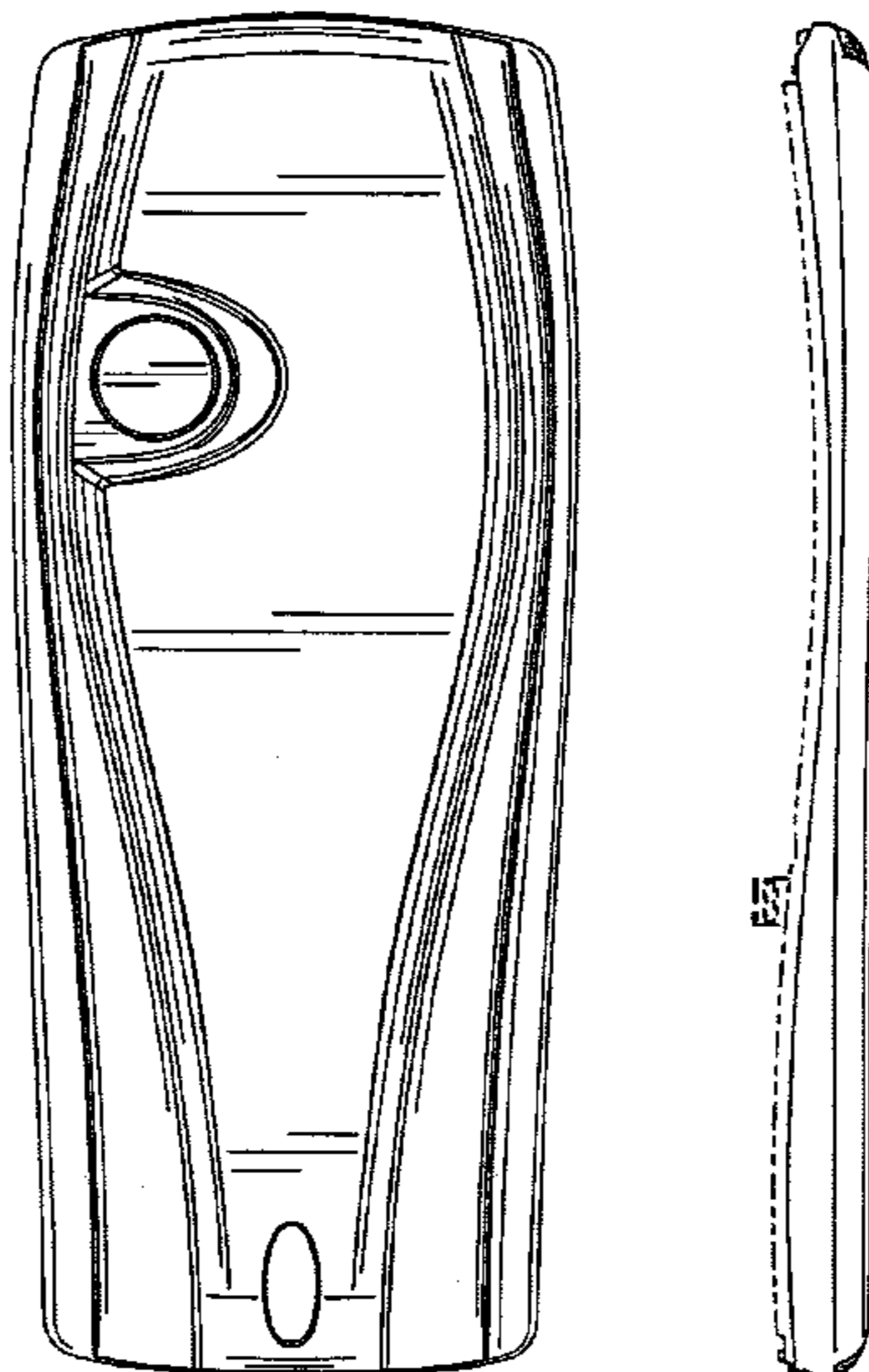

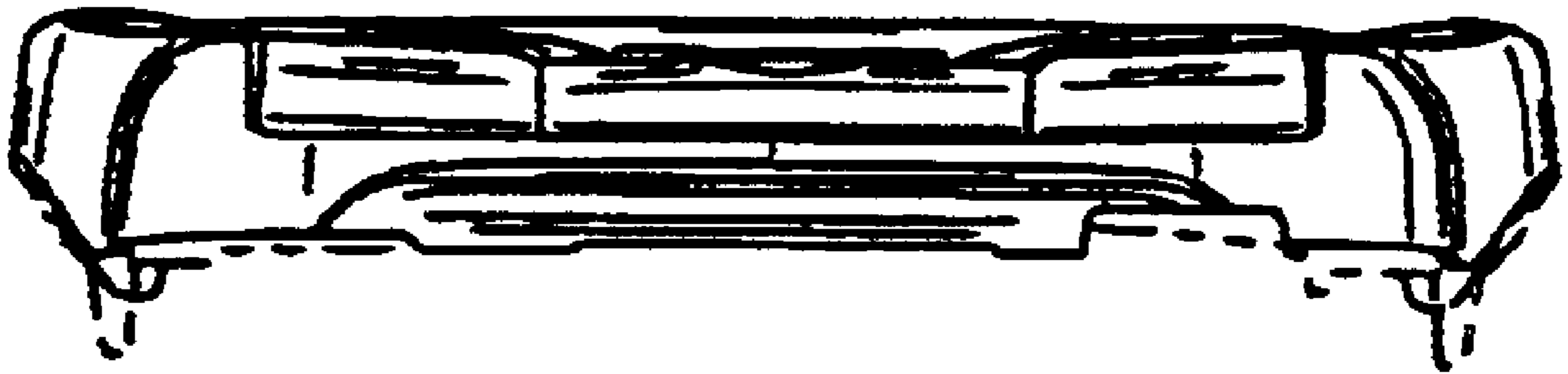

FIG. 1



FIG. 2

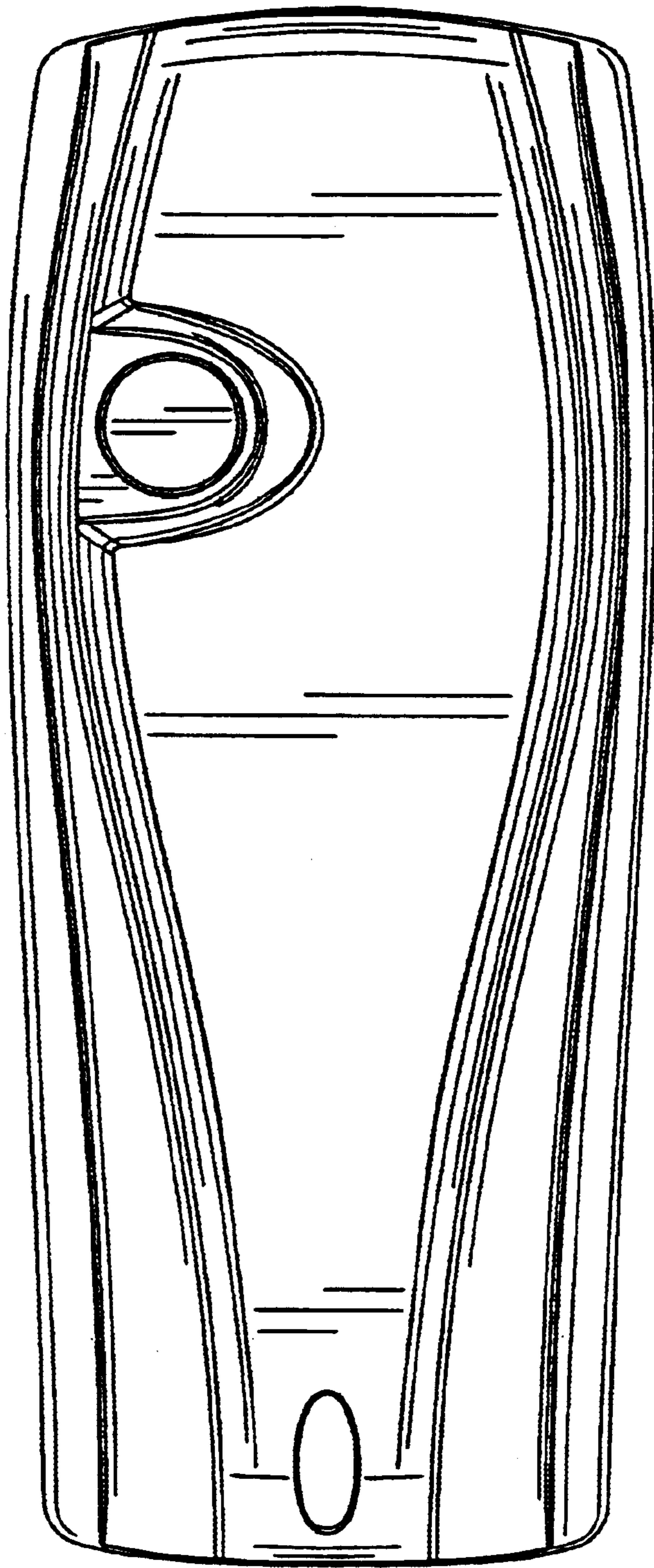

FIG. 3

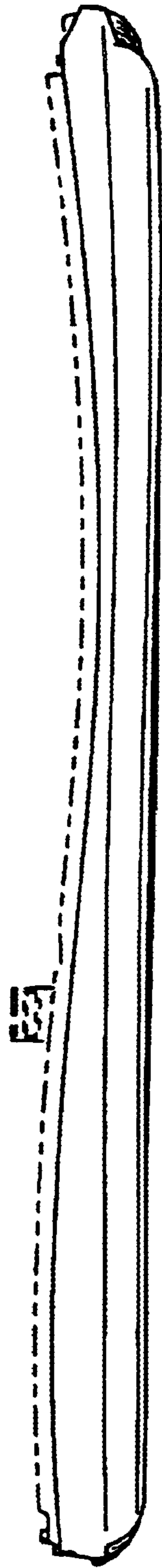

FIG. 4

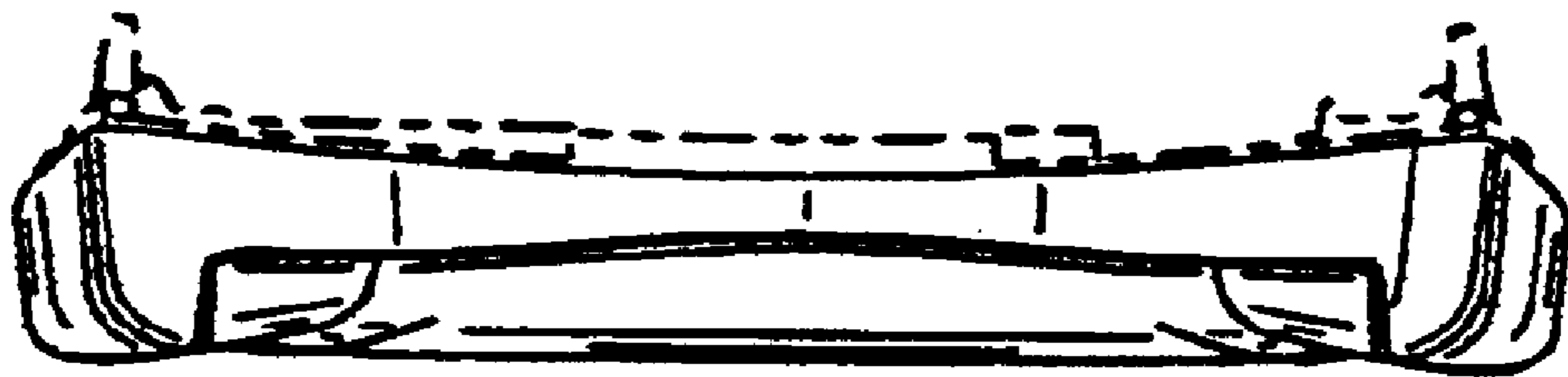

FIG. 5

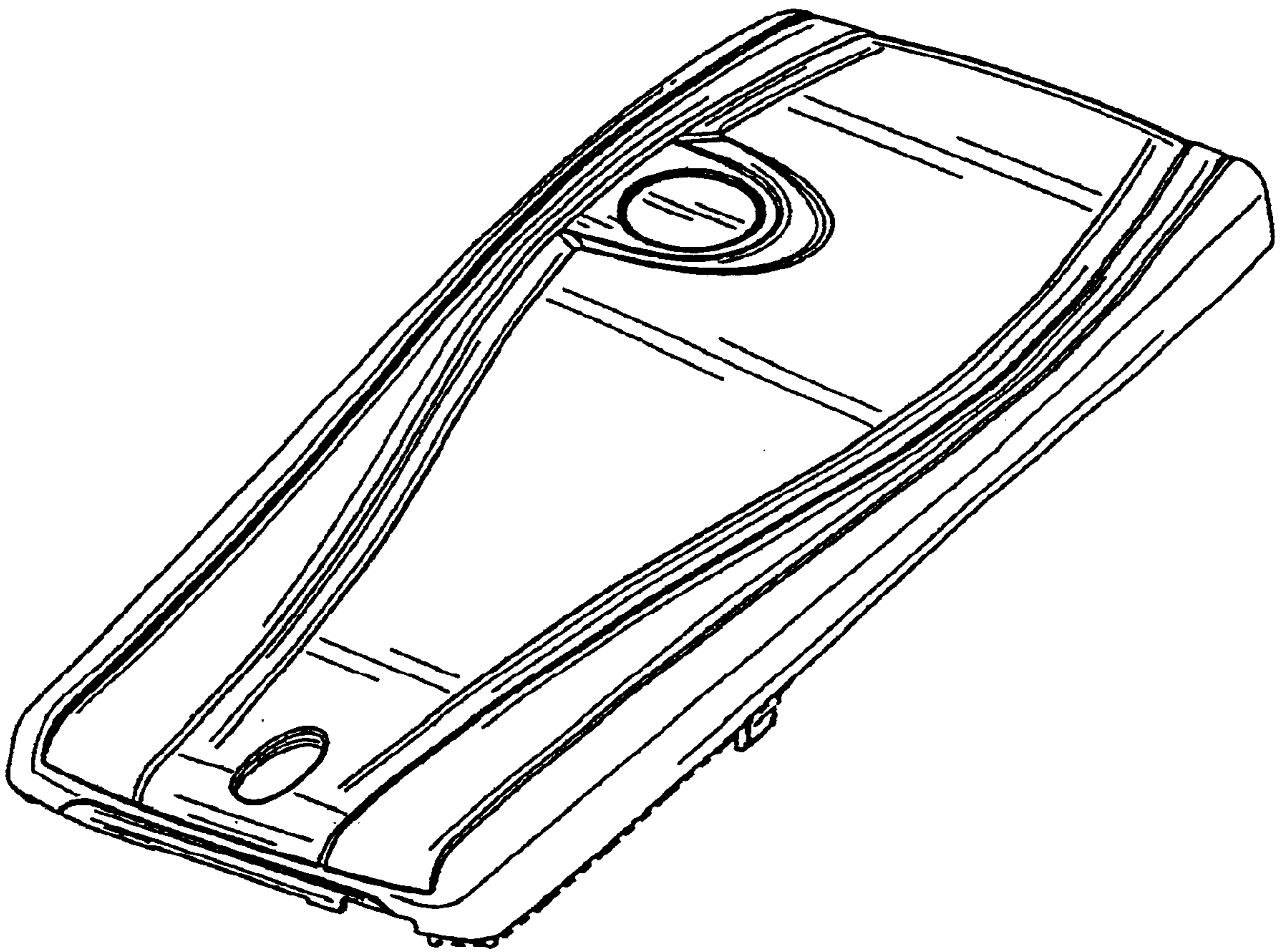

FIG. 6

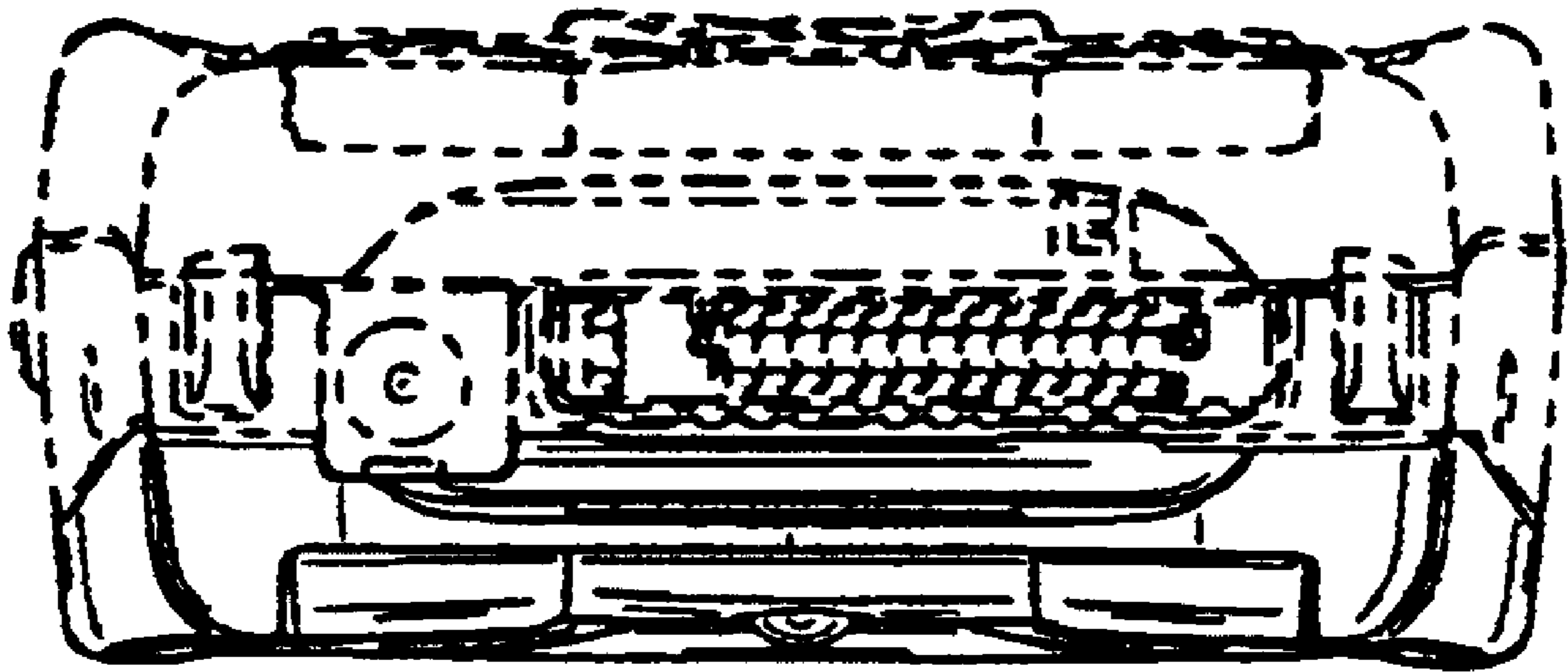

FIG. 7

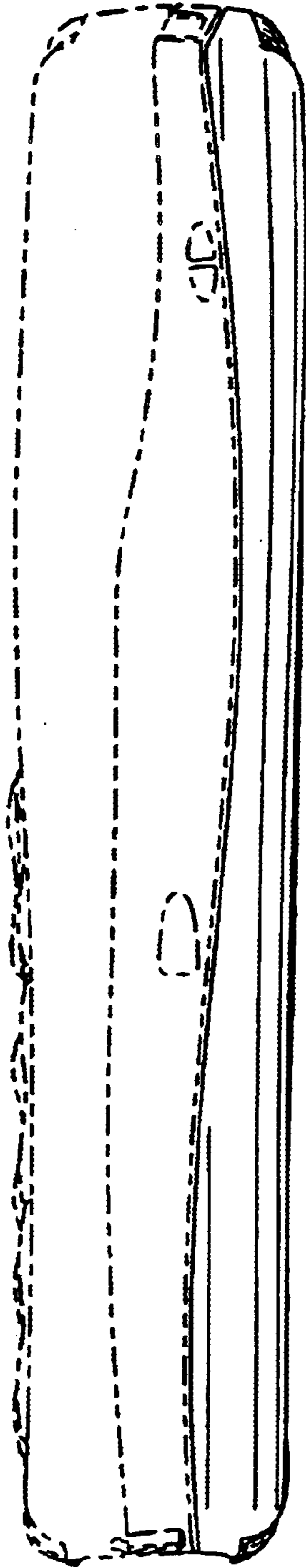

FIG. 8

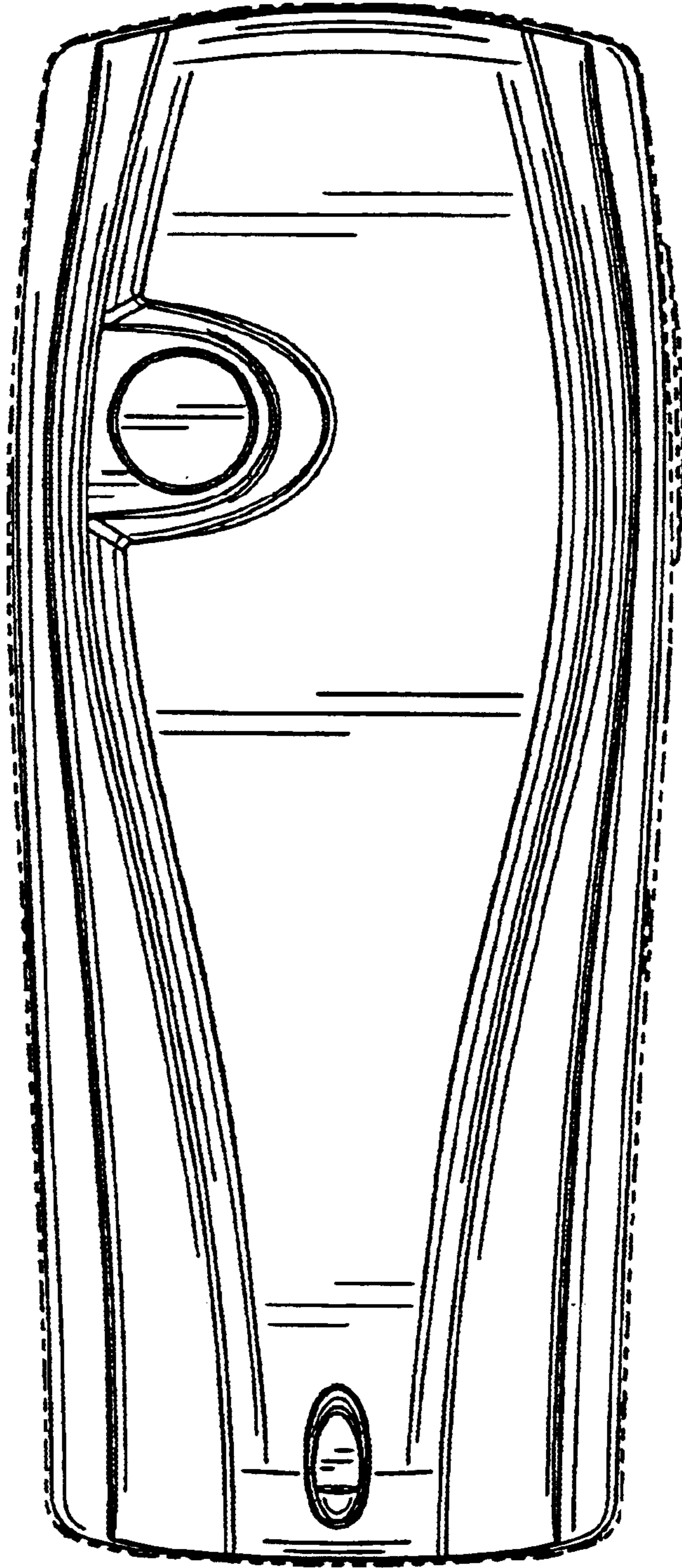

FIG. 9

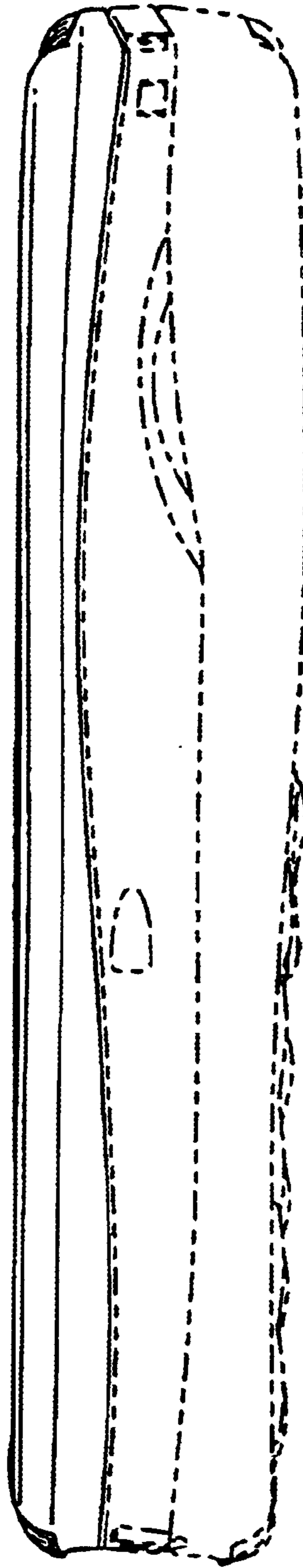

FIG. 10

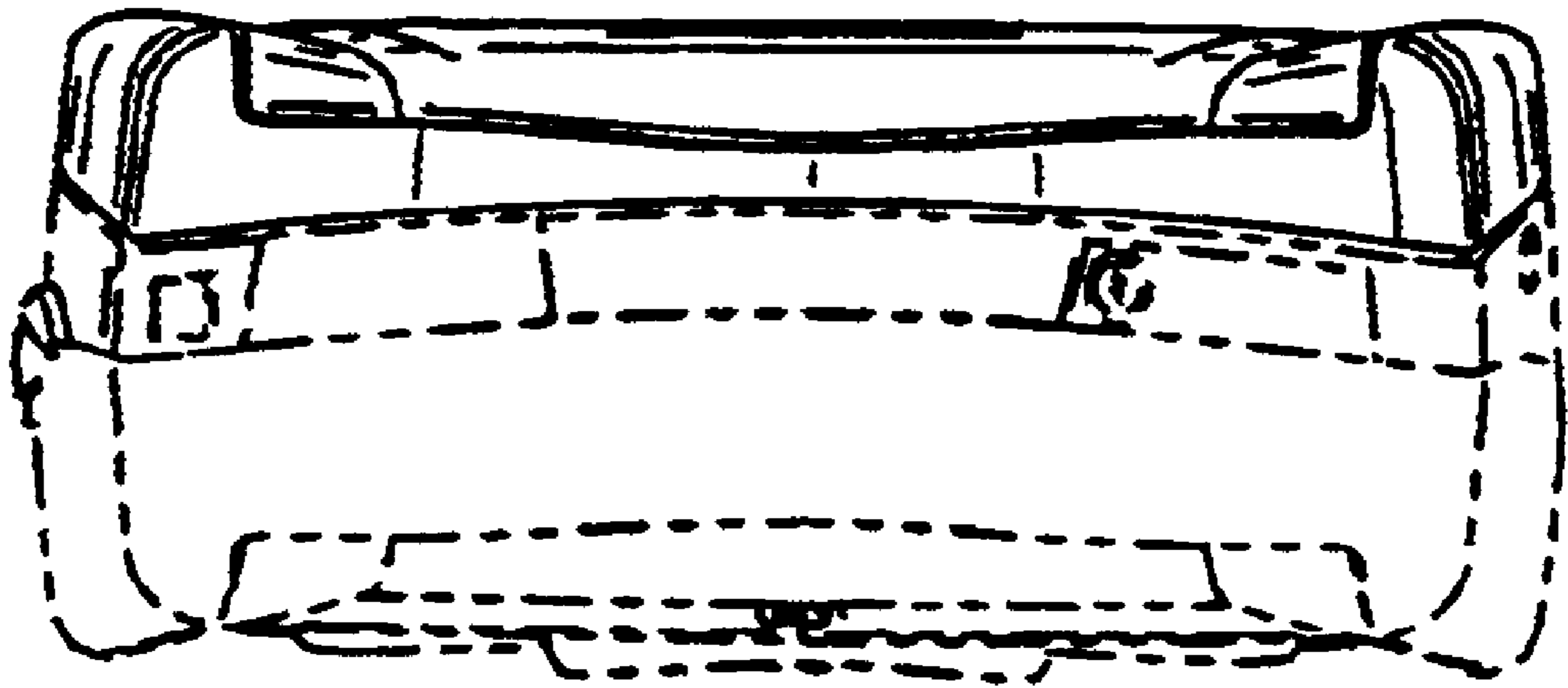

FIG. 11

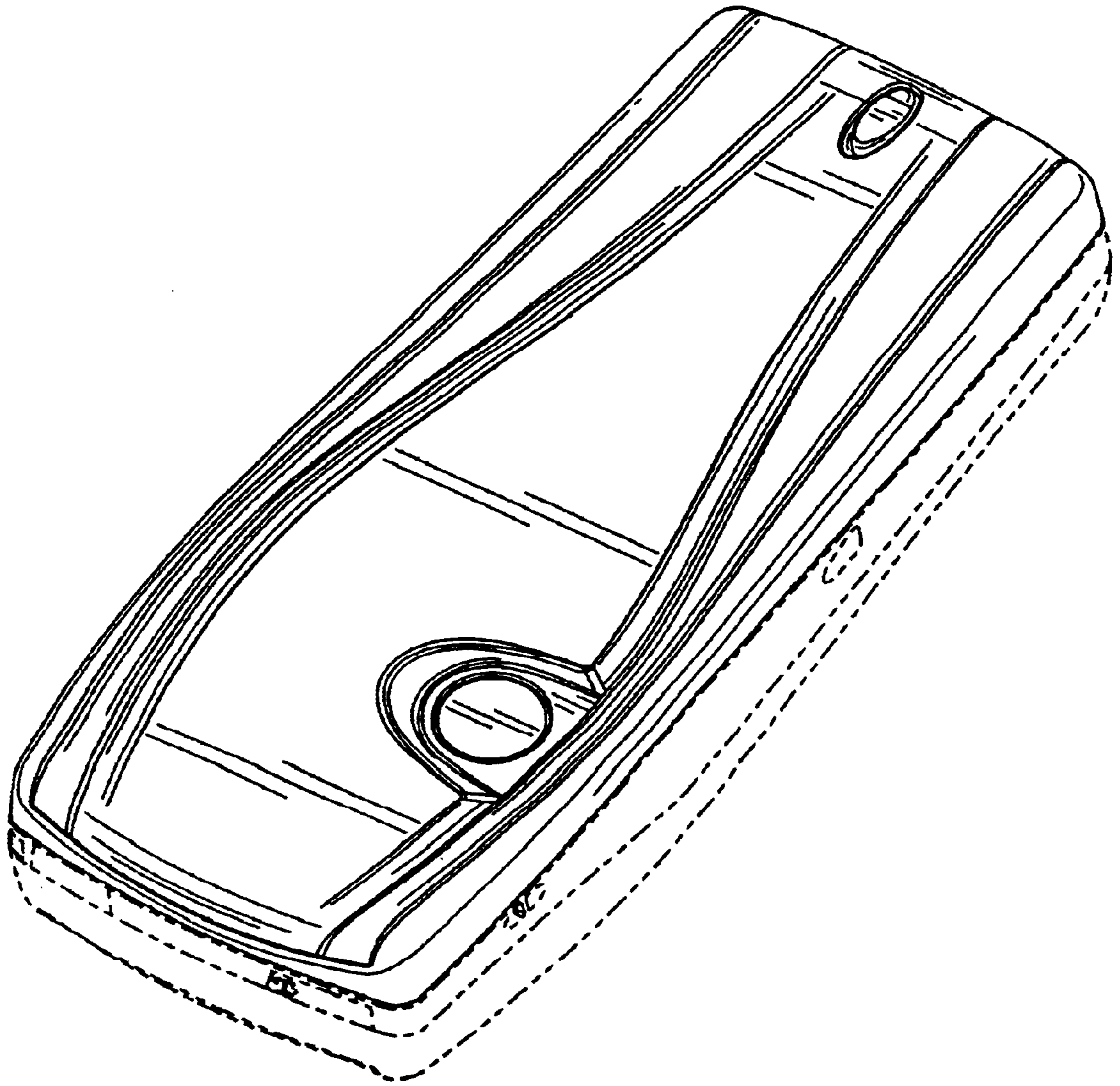

FIG. 12

UNITED STATES PATENT AND TRADEMARK OFFICE
CERTIFICATE OF CORRECTION

PATENT NO. : Des. 490,409 S
DATED : May 25, 2004
INVENTOR(S) : Dimitre D. Mehandjiysky

Page 1 of 1

It is certified that error appears in the above-identified patent and that said Letters Patent is hereby corrected as shown below:

Title page,

Item [57], **CLAIM,**
DESCRIPTION,

“FIG. 7 is a bottom plan view of a second embodiment of the front cover for a handset of FIG. 1;” has been replaced with -- FIG. 7 is a bottom plan view of a second embodiment of the back cover for a handset of FIG. 1; --

“FIG. 12 is a perspective view thereof.” has been replaced with -- FIG. 12 is a perspective front view thereof. --

“The broken line showings are for illustrative purposes only and form no part of the claimed design.” has been replaced with -- The broken line showing of the internal surfaces and the extending tabs in FIGS. 1-6 and the remainder of the handset in FIGS. 7-12 are for illustrative purposes only and form no part of the claimed design. --

Signed and Sealed this

Fourteenth Day of December, 2004

A handwritten signature in black ink on a light gray dotted background. The signature reads "Jon W. Dudas" in a cursive style.

JON W. DUDAS

Director of the United States Patent and Trademark Office