



US00D490302S

(12) **United States Design Patent**  
**Nakatani**

(10) **Patent No.:** **US D490,302 S**

(45) **Date of Patent:** **\*\* May 25, 2004**

(54) **PACKAGE**

(75) Inventor: **Hiroshi Nakatani**, Tondabayashi (JP)

(73) Assignee: **Sanyo Co., Ltd.**, Osaka (JP)

(\*\*) Term: **14 Years**

(21) Appl. No.: **29/178,501**

(22) Filed: **Mar. 28, 2003**

(51) **LOC (7) Cl.** ..... **09-05**

(52) **U.S. Cl.** ..... **D9/305**

(58) **Field of Search** ..... D9/305, 302, 306,  
D9/416; 383/89, 90, 104, 119, 210, 211;  
206/439, 364, 306, 212; 374/208, 160;  
D24/118; 220/359.3

(56) **References Cited**

**U.S. PATENT DOCUMENTS**

D212,150 S \* 9/1968 Caliman ..... D9/416

(List continued on next page.)

*Primary Examiner*—Paula A. Greene

(74) *Attorney, Agent, or Firm*—Rothwell, Figg, Ernst & Manbeck; Stephen B. Parker

(57) **CLAIM**

The ornamental design for a package, as shown and described.

**DESCRIPTION**

FIG. 1 is a top plan view of a package showing my new design, the broken line showing of the applicator is for illustrative purposes only and forms no part of the claimed design;

FIG. 2 is a left side elevational view of the package shown in FIG. 1, the right side elevational view being a mirror image thereof;

FIG. 3 is a front view of the package shown in FIG. 1;

FIG. 4 is a rear view of the package shown in FIG. 1;

FIG. 5 is a top plan view showing a second embodiment of the invention in which the package shown in FIG. 1 is partly opened at a notch part;

FIG. 6 is a top plan view showing a third embodiment of the invention in which the package shown in FIG. 1 is separated to form an opened package;

FIG. 7 is a perspective view thereof, the broken line showing of the human form is for illustrative purposes only and forms no part of the claimed design;

FIG. 8 is a top plan view of the fourth embodiment thereof, the broken line showing of the applicator is for illustrative purposes only and forms no part of the claimed design, the bottom plan view is a mirror image thereof;

FIG. 9 is a left side elevational view of the package shown in FIG. 8, the right side elevational view being a mirror image thereof;

FIG. 10 is a front view of the package shown in FIG. 8;

FIG. 11 is a rear view of the package shown in FIG. 8;

FIG. 12 is a top plan view showing a fifth embodiment of the invention in which the package shown in FIG. 8 is partly opened at a notch part;

FIG. 13 is a top plan view showing a sixth embodiment of the invention in which the package shown in FIG. 8 is separated to form an opened package;

FIG. 14 is a perspective view of a portion of the package in FIG. 13 shown for purposes of illustration, the broken line showing of the human form is for illustrative purposes only and forms no part of the claimed design;

FIG. 15 is a plan view of the seventh embodiment of my new design, the broken lines are for illustrative purposes only and form no part of the claimed design, the bottom is a mirror image thereof;

FIG. 16 is a left side elevational view of the package shown in FIG. 15, the right side elevational view being a mirror image thereof;

FIG. 17 is a front view of the package shown in FIG. 15;

FIG. 18 is a rear view of the package shown in FIG. 15;

FIG. 19 is a top plan view showing an eighth embodiment of the invention in which the package shown in FIG. 15 is partly opened;

FIG. 20 is a top plan view showing a ninth embodiment of the invention in which the package shown in FIG. 15 is separated to form an opened package; and,

FIG. 21 is a perspective view of a portion of the package in FIG. 20 shown for purposes of illustration, the broken lines are for illustrative purposes only and form no part of the claimed design.

**1 Claim, 9 Drawing Sheets**

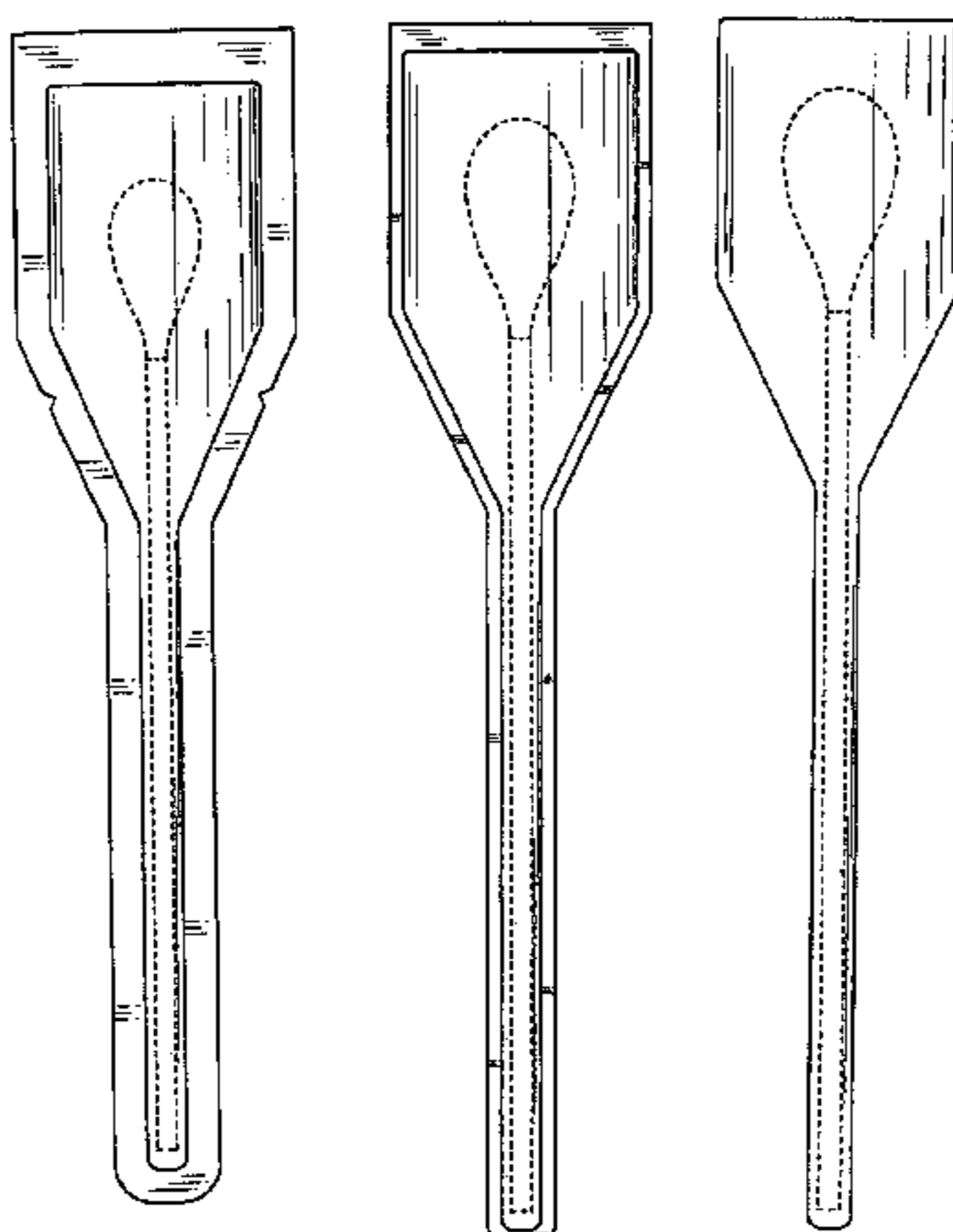

# US D490,302 S

Page 2

---

U.S. PATENT DOCUMENTS			
		D300,947 S * 5/1989	Utas-Sjoberg ..... D24/118
		5,401,100 A * 3/1995	Thackston et al. .... 374/208
3,910,410 A * 10/1975	Shaw ..... 220/359.3		
3,926,311 A * 12/1975	Laske ..... 206/439		* cited by examiner

【FIG. 1】

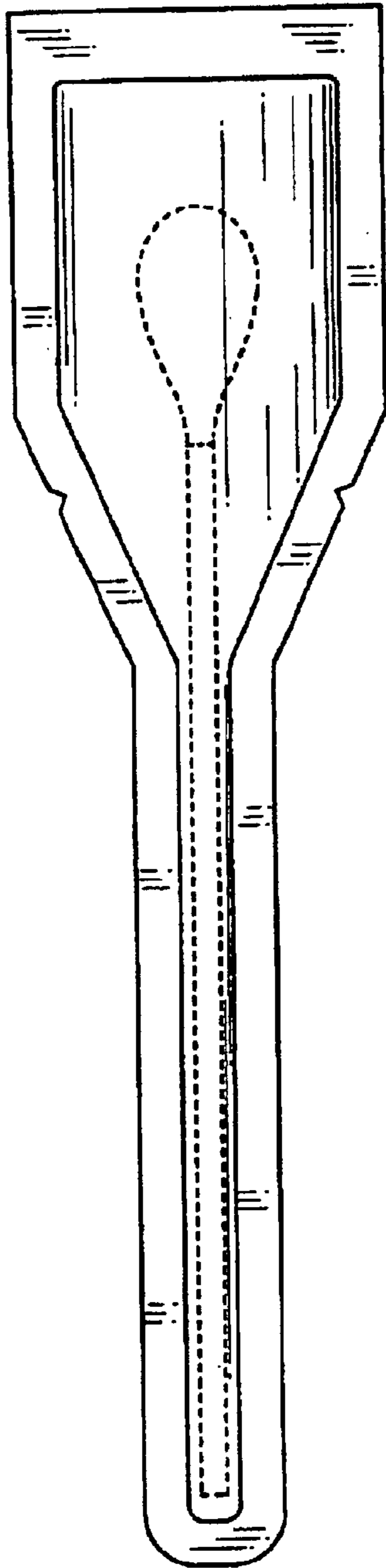

【FIG. 2】

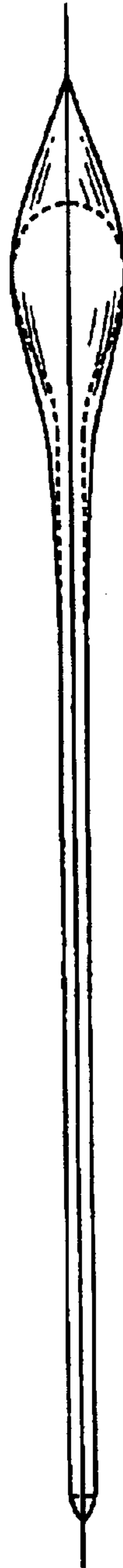

【FIG. 3】

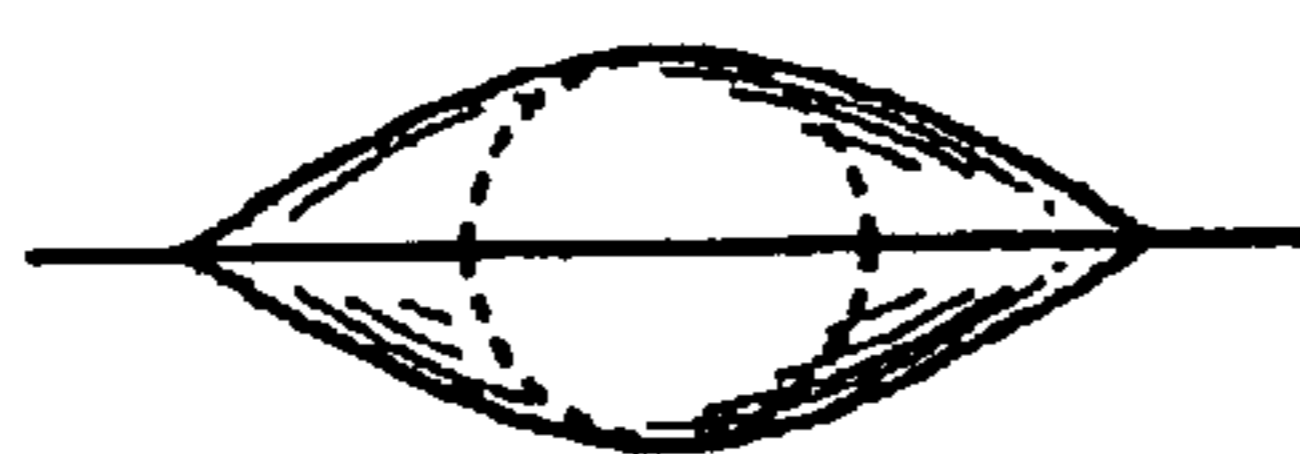

【FIG. 4】

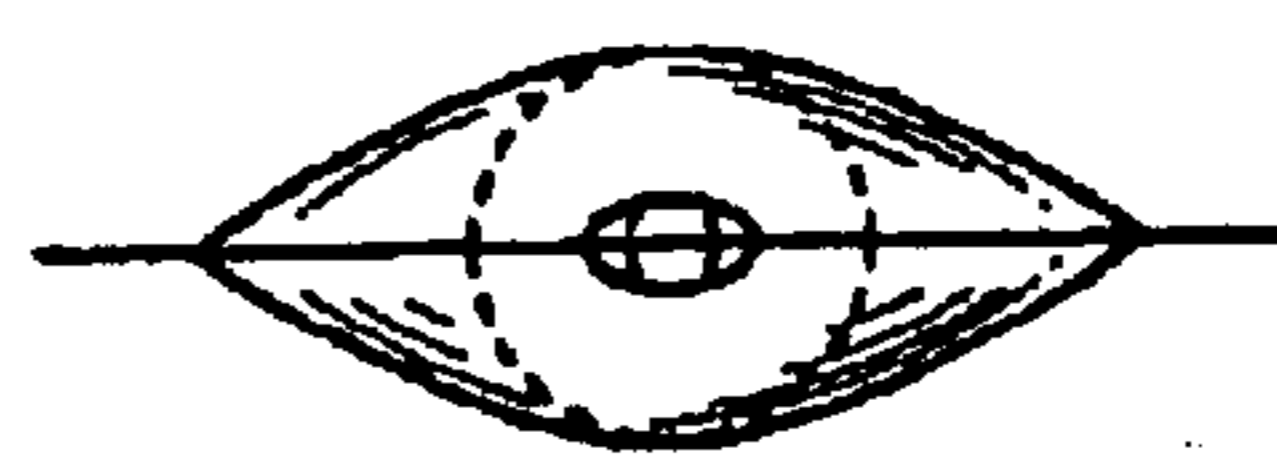

FIG. 5

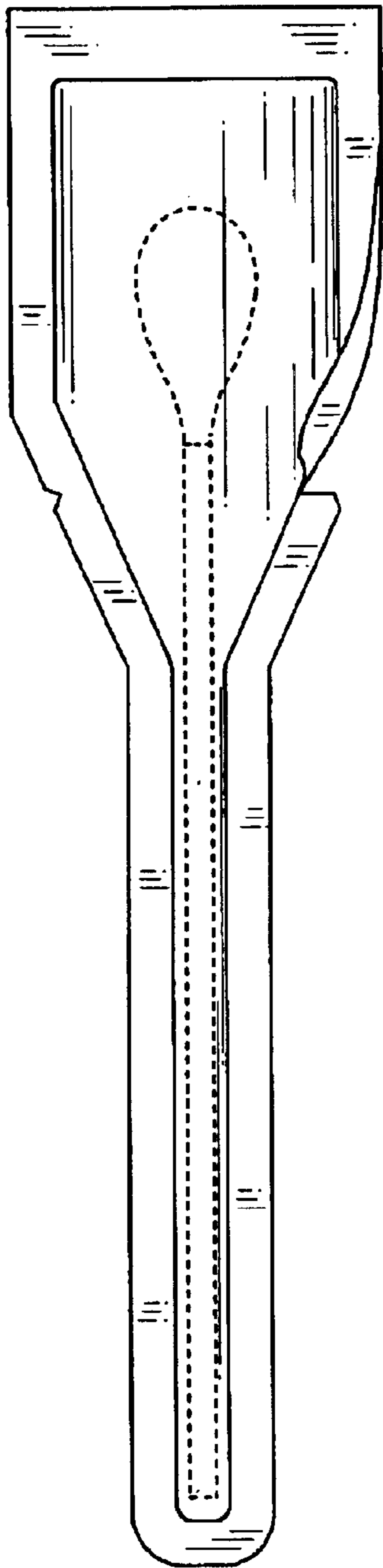
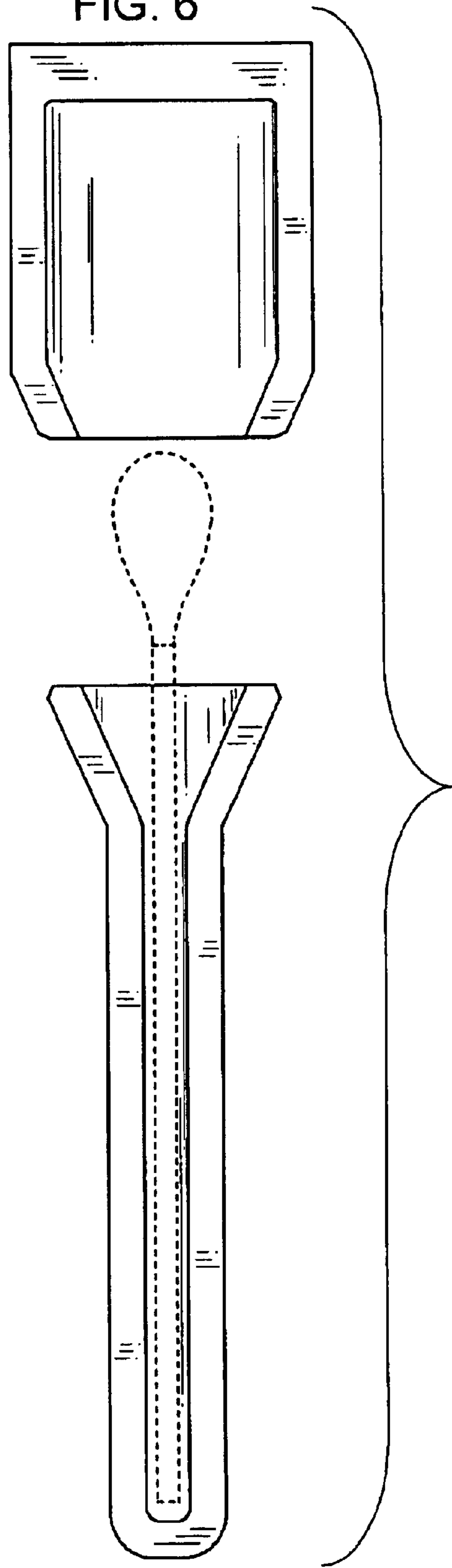
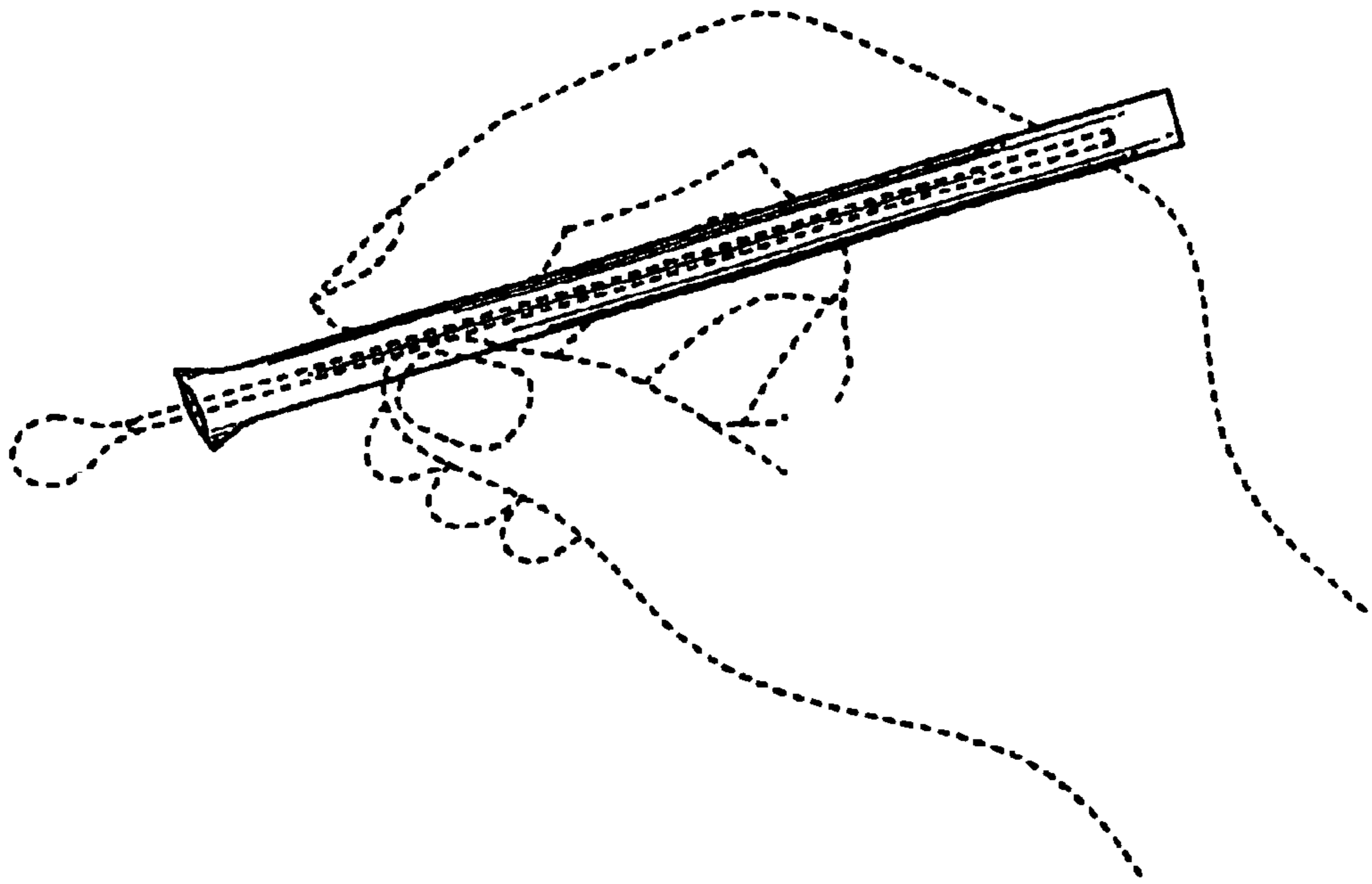

FIG. 6



【FIG. 7】



【FIG. 8】

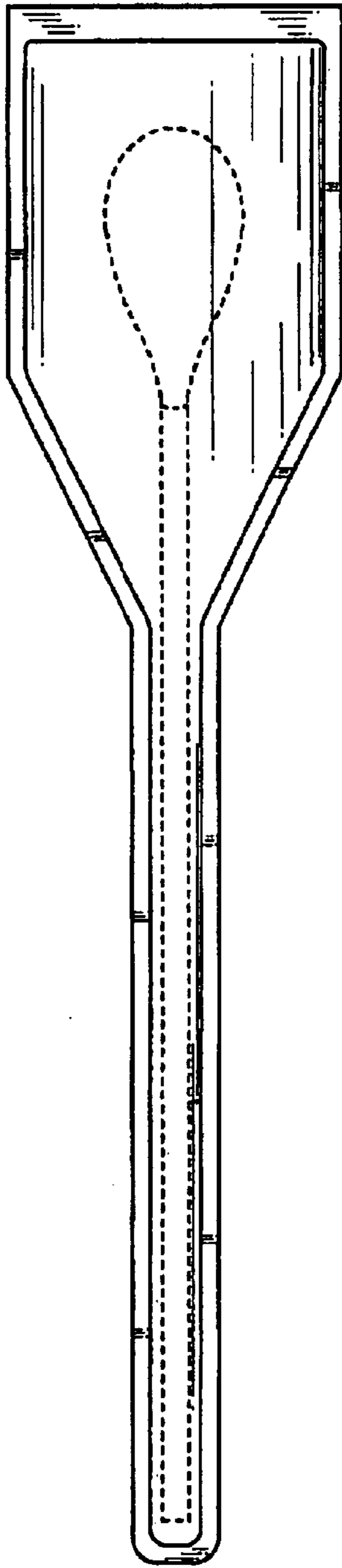

【FIG. 9】



【FIG. 10】



【FIG. 11】

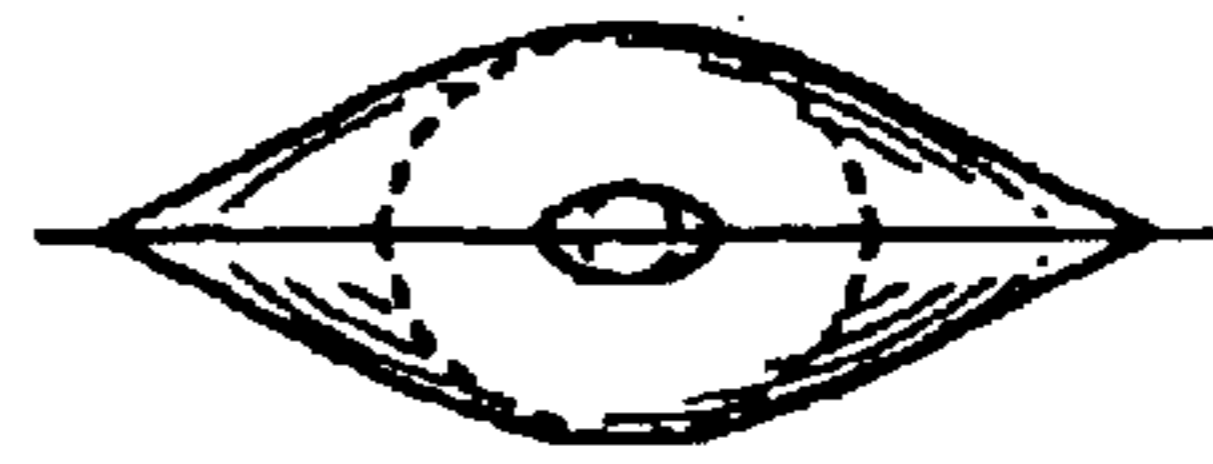

FIG. 12

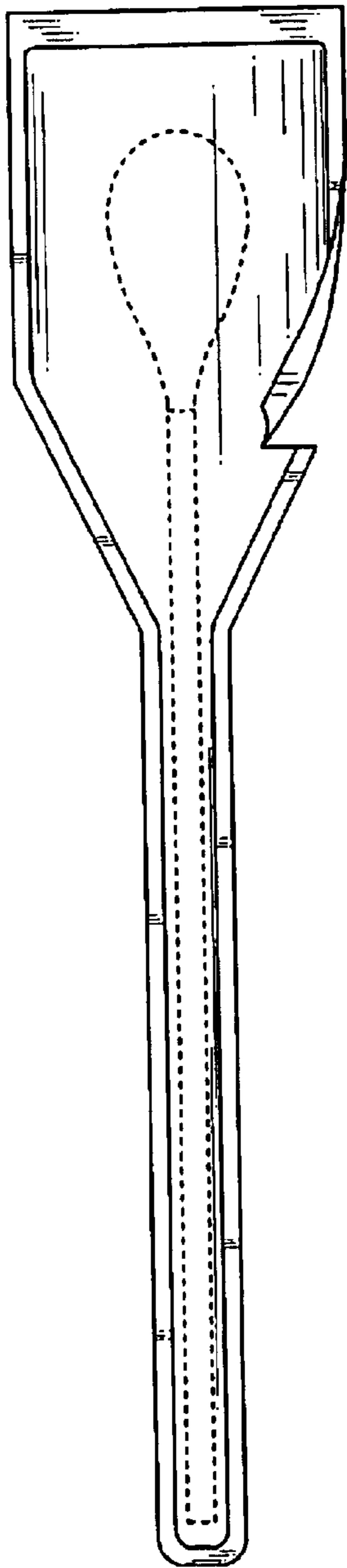
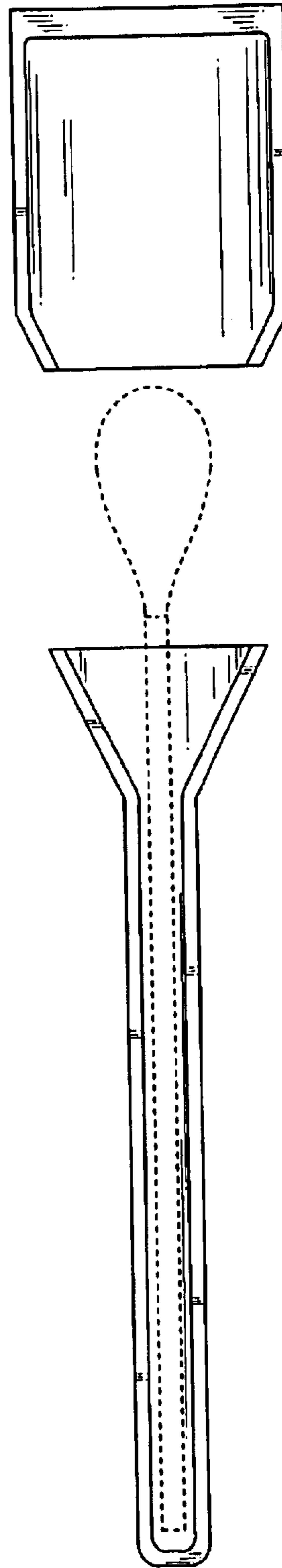
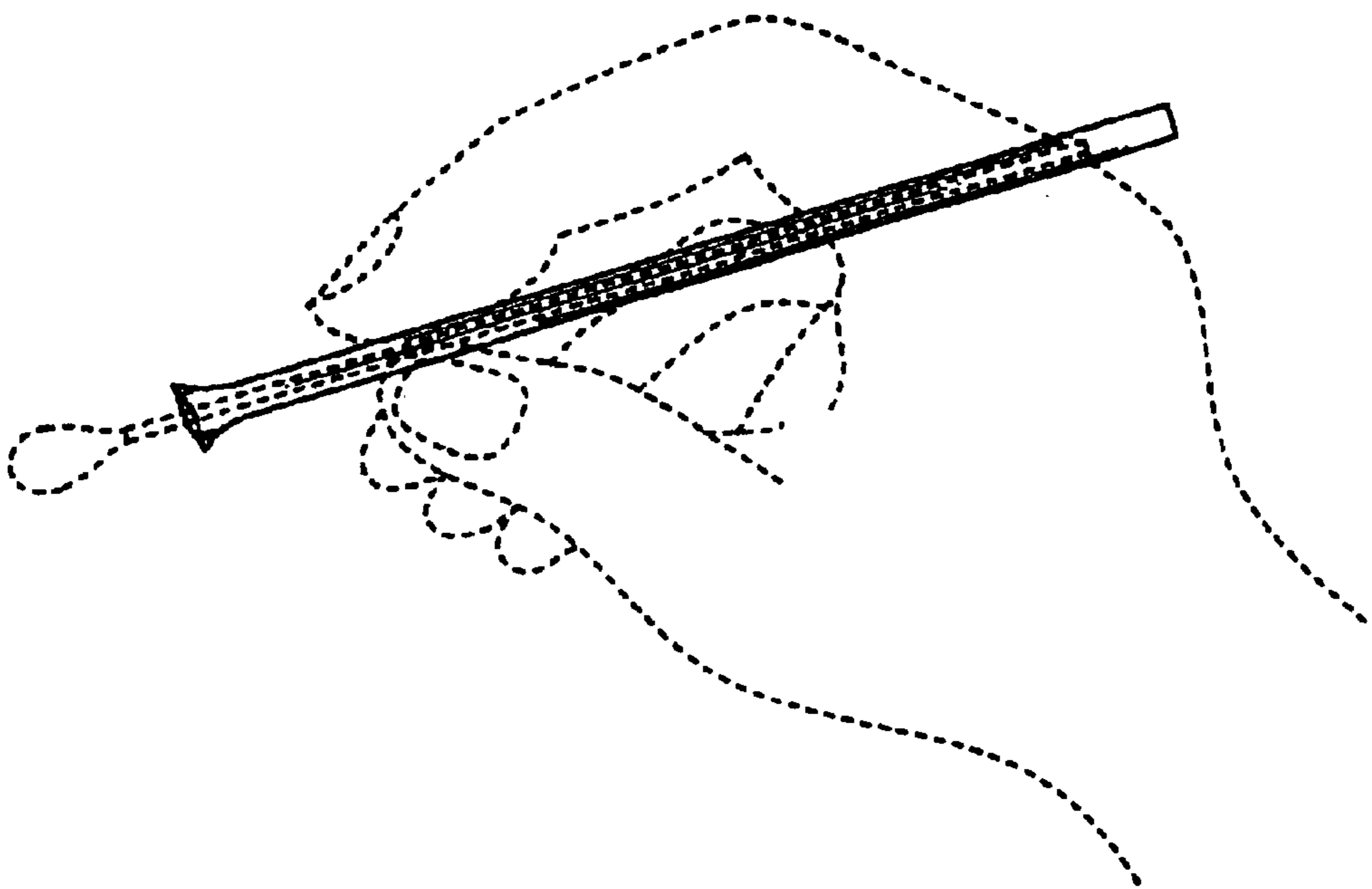

FIG. 13



【FIG. 14】





【FIG. 15】

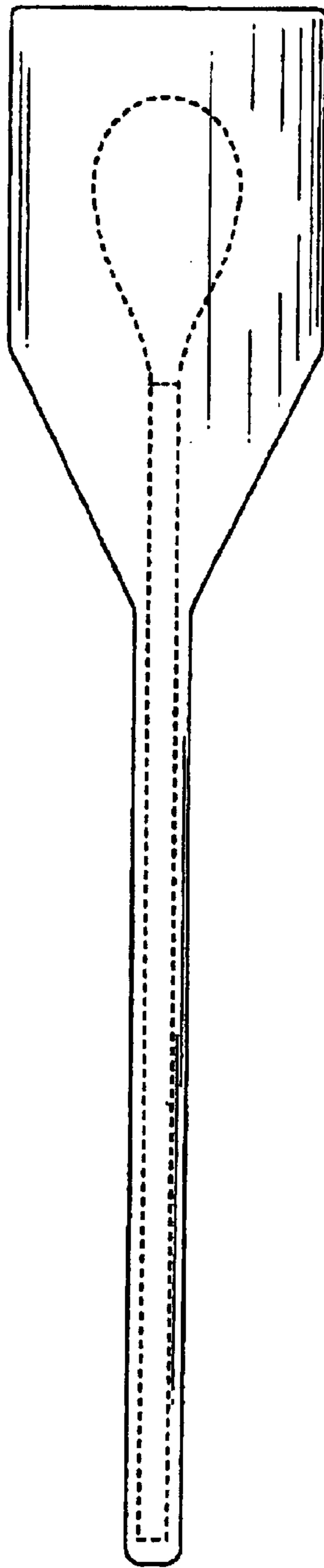

【FIG. 16】

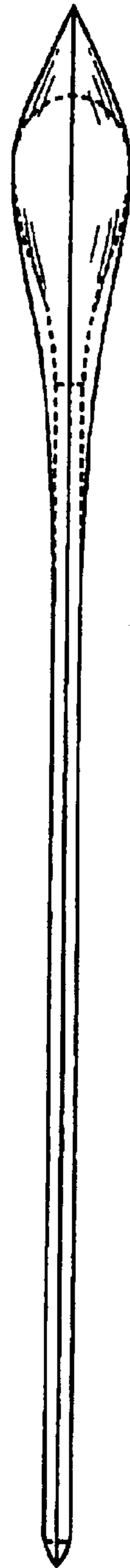

【FIG. 17】

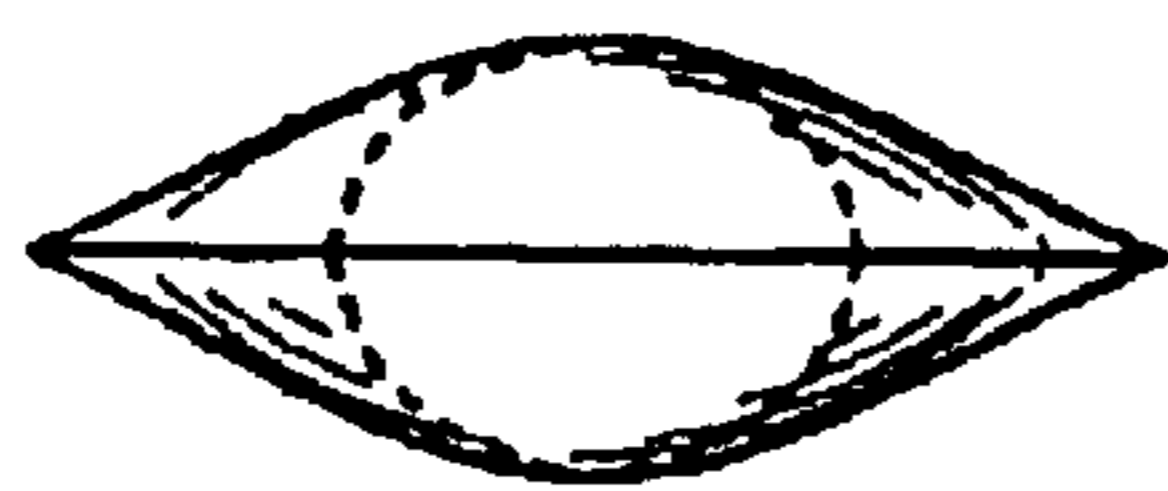

【FIG. 18】

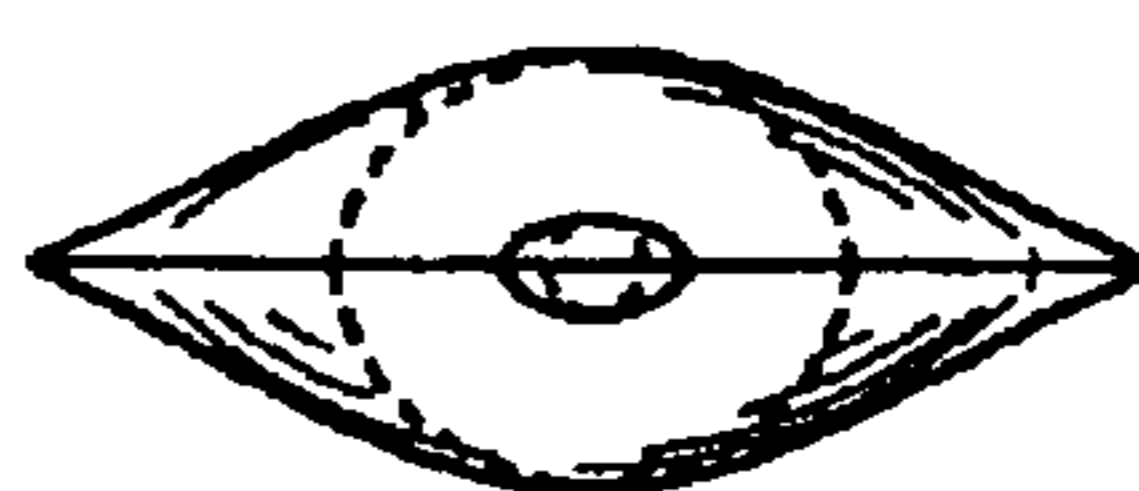

FIG. 19

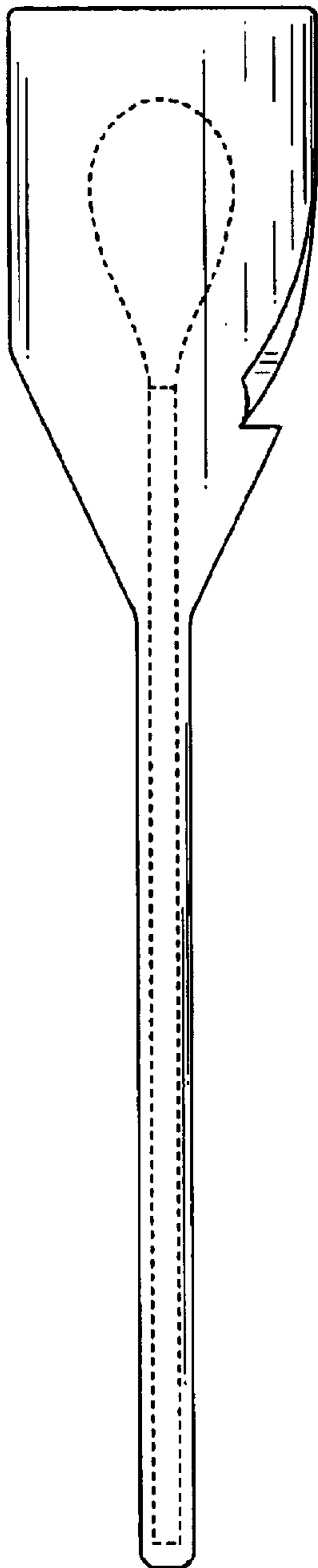
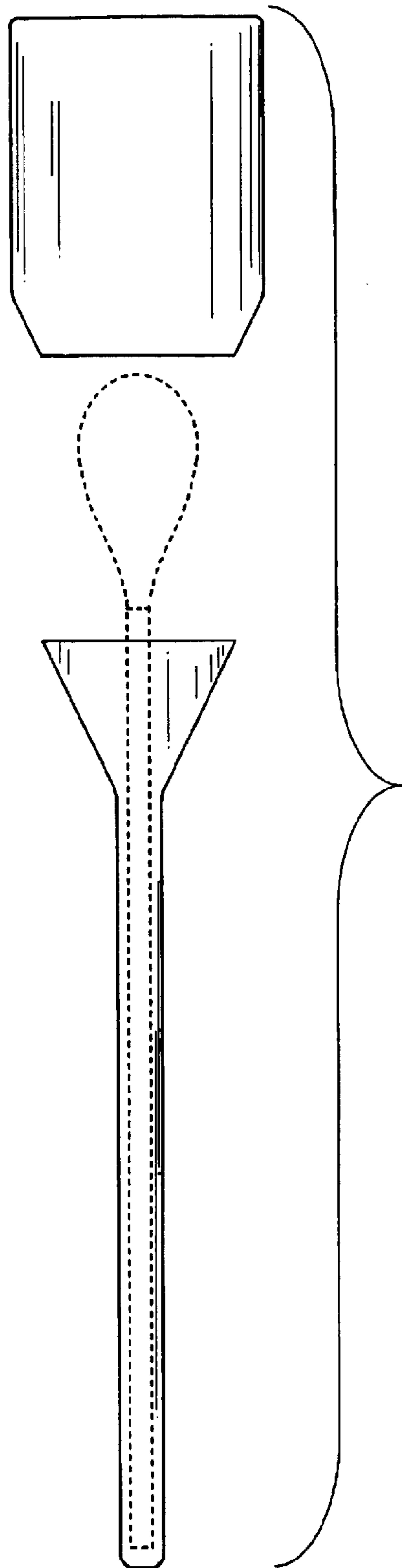

FIG. 20



【FIG. 21】

