



US00D490171S

(12) **United States Design Patent**
Hung

(10) **Patent No.:** **US D490,171 S**

(45) **Date of Patent:** **** May 18, 2004**

(54) **AUTOMOBILE LIGHT**

D472,655 S * 4/2003 Lin D26/28
D472,656 S * 4/2003 Pfeiffer et al. D26/28

(75) Inventor: **Chi-Chung Hung**, Tainan (TW)

* cited by examiner

(73) Assignee: **TYC Brother Industrial Co., Ltd.**,
Tainan (TW)

Primary Examiner—Marcus A. Jackson

(**) Term: **14 Years**

(74) *Attorney, Agent, or Firm*—Fitzpatrick, Cella, Harper &
Scinto

(21) Appl. No.: **29/171,976**

(57) **CLAIM**

(22) Filed: **Dec. 4, 2002**

The ornamental design for automobile light, as shown and
described.

(51) **LOC (7) Cl.** **26-06**

DESCRIPTION

(52) **U.S. Cl.** **D26/28**

(58) **Field of Search** D26/28-36, 120,
D26/122; 362/61, 80, 81, 82, 83, 83.4,
267, 269, 275

FIG. 1 is a perspective view of automobile light showing my
new design;
FIG. 2 is a front elevational view thereof;
FIG. 3 is a rear elevational view thereof;
FIG. 4 is a left side elevational view thereof;
FIG. 5 is a right side elevational view thereof;
FIG. 6 is a top plan view thereof; and,
FIG. 7 is a bottom plan view thereof.

(56) **References Cited**

U.S. PATENT DOCUMENTS

D465,040 S * 10/2002 Lin D26/28
D466,635 S * 12/2002 Lin D26/28
D467,020 S * 12/2002 Lin D26/28

1 Claim, 4 Drawing Sheets

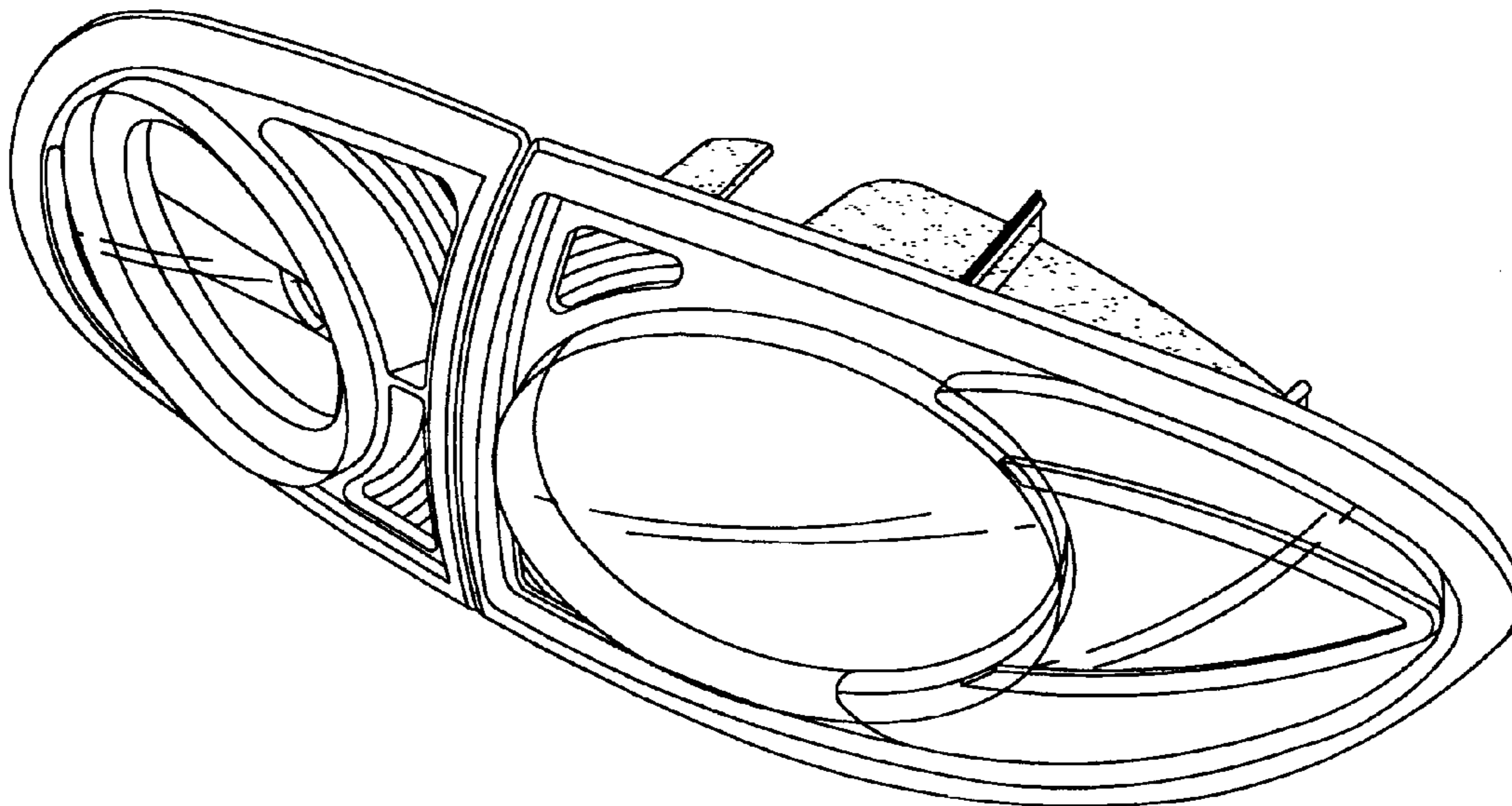

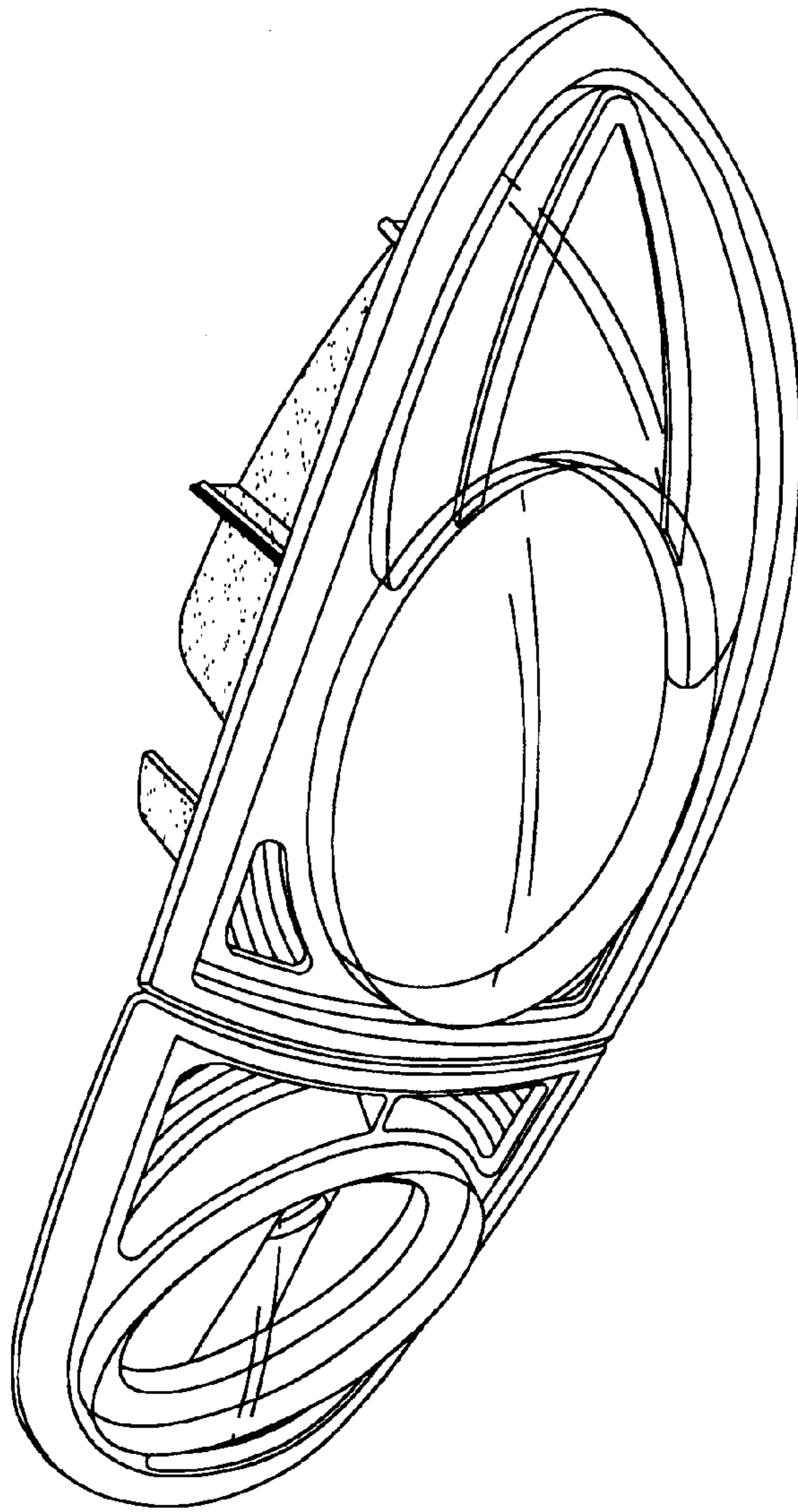

FIG. 1

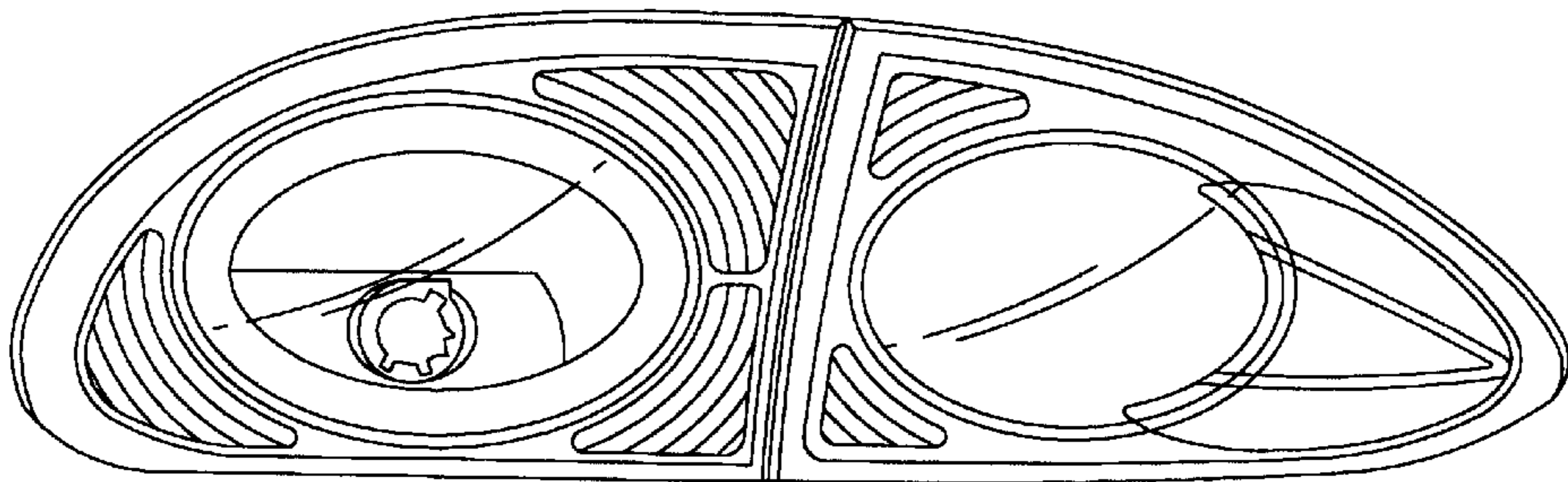

FIG. 2

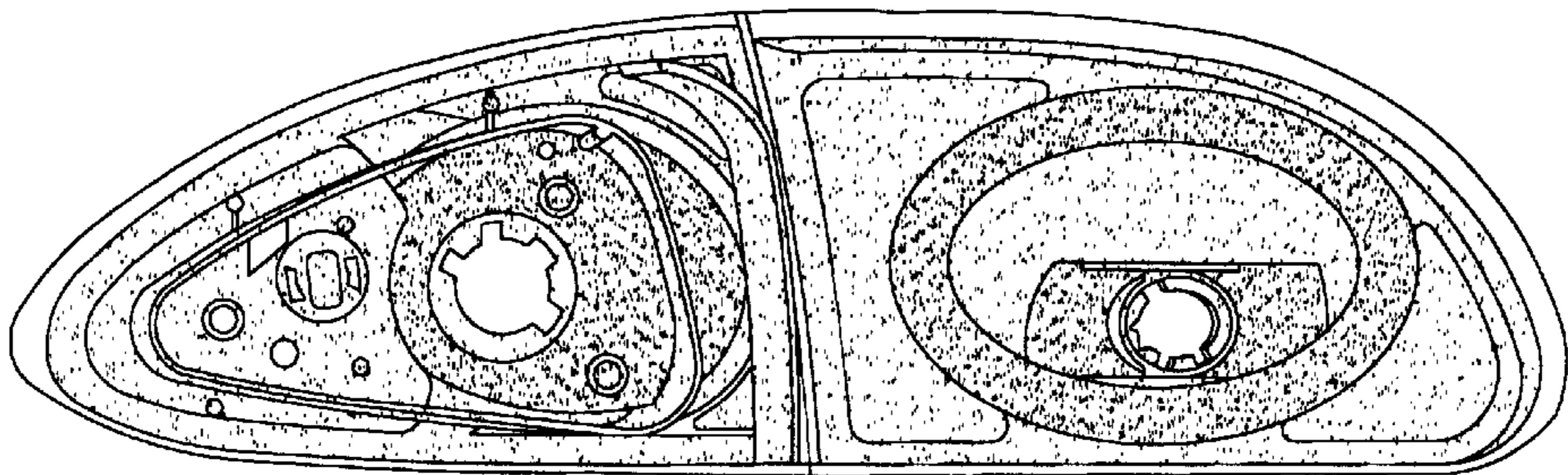

FIG. 3

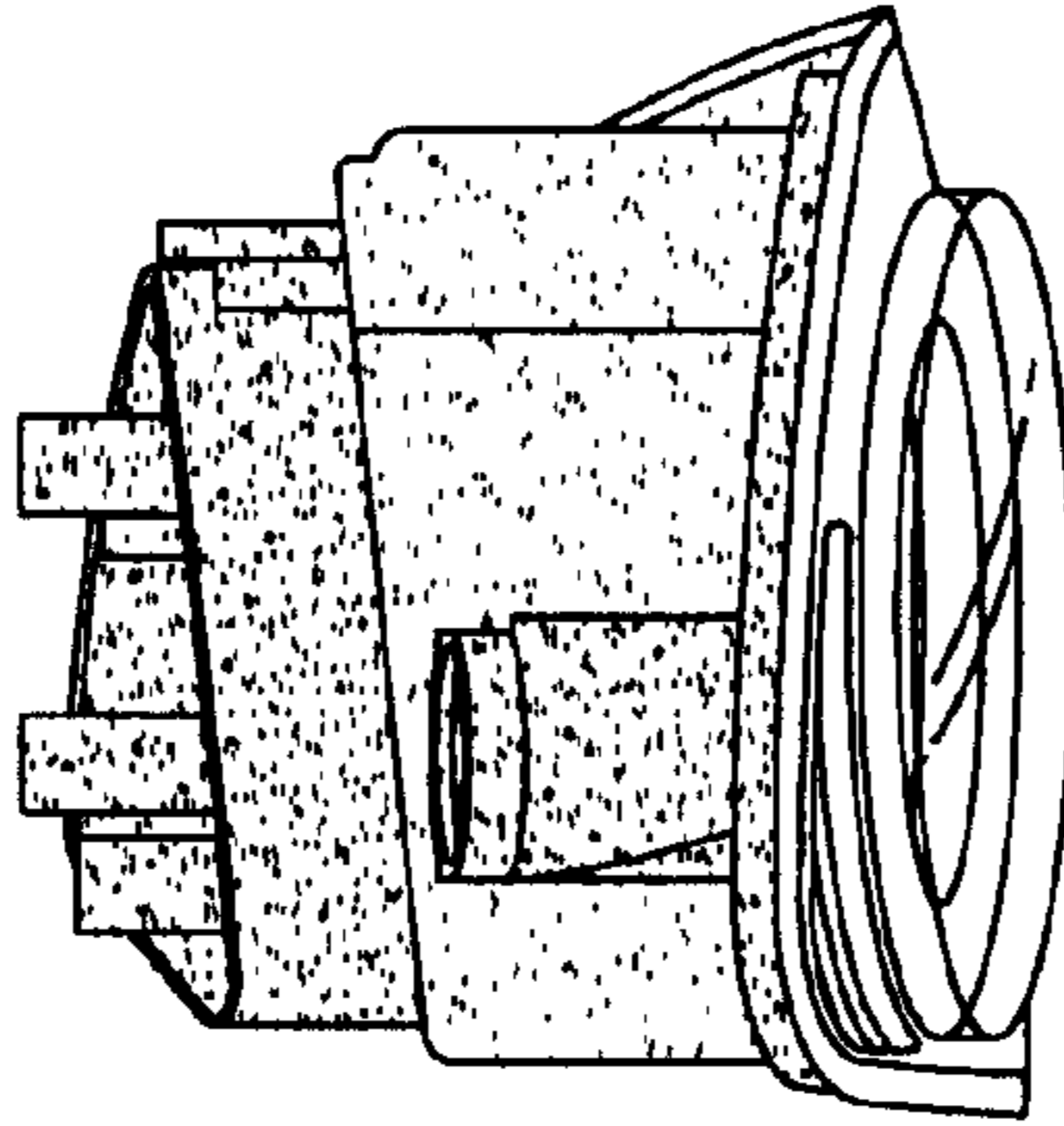

FIG. 4

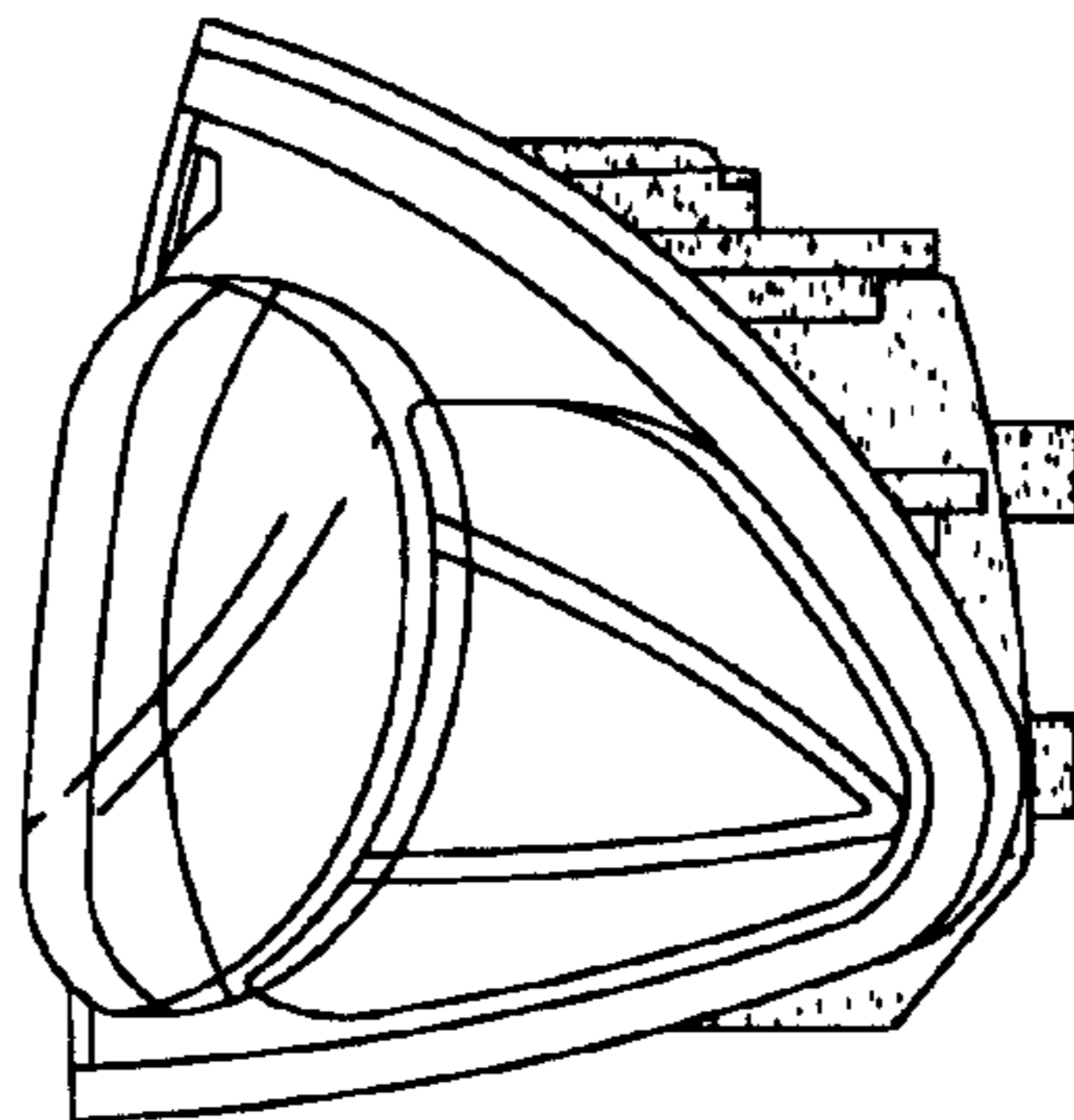

FIG. 5

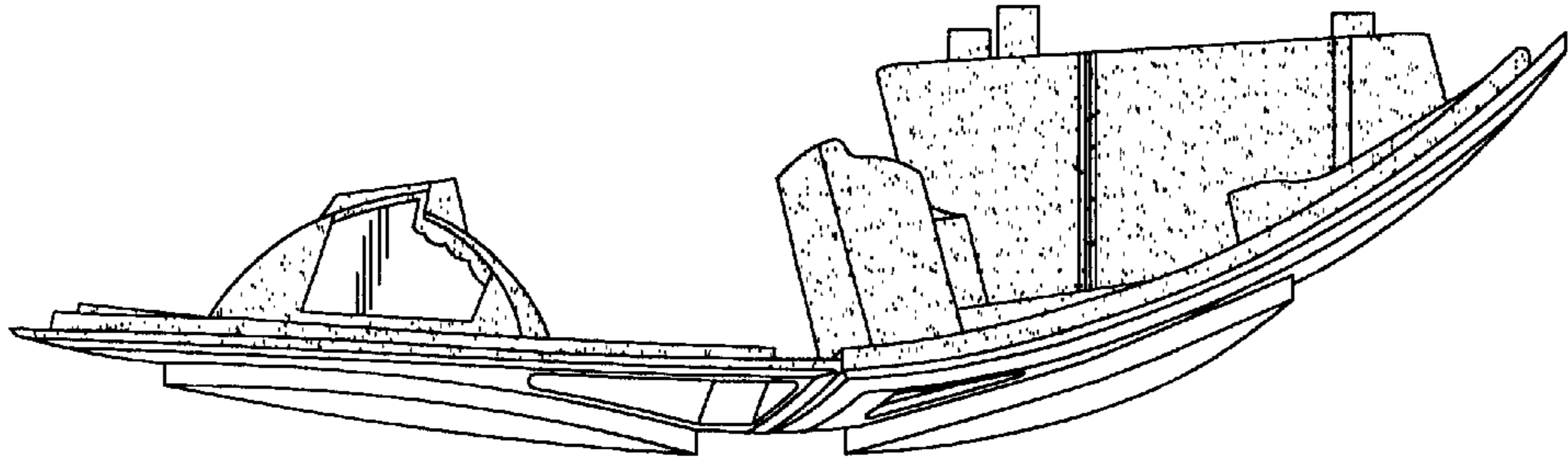

FIG. 6

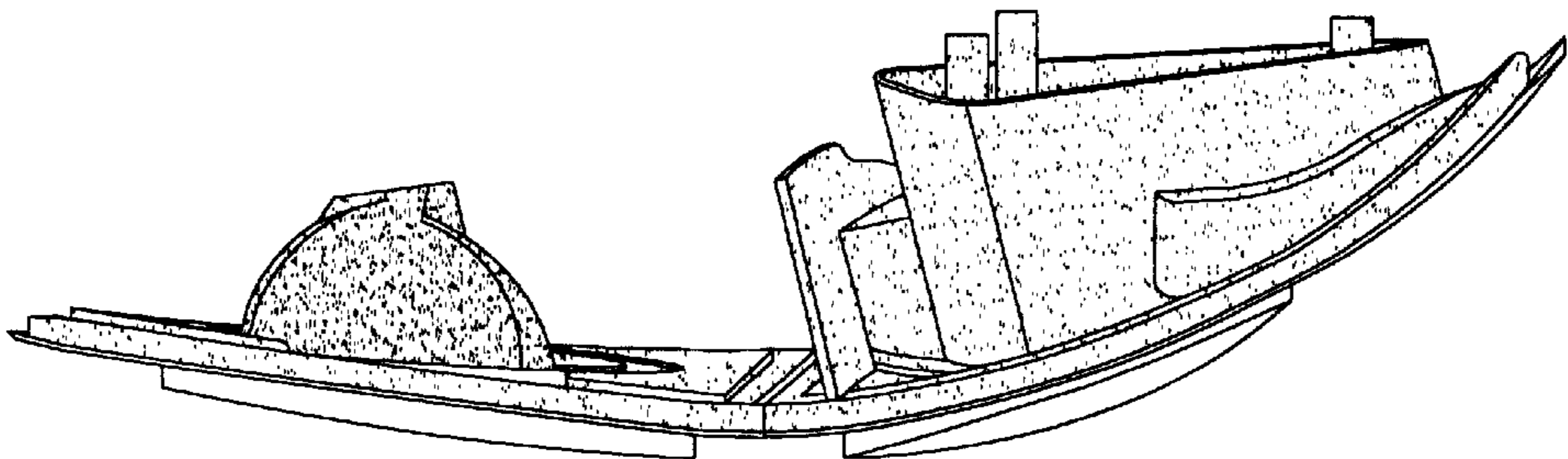

FIG. 7