



US00D490112S

(12) **United States Design Patent**
Hadzic et al.

(10) **Patent No.:** **US D490,112 S**

(45) **Date of Patent:** **** May 18, 2004**

(54) **TAG FOR INTRAVENOUS INFUSION SYSTEMS**

(75) Inventors: **Admir Hadzic**, Montclair, NJ (US);
Sergio Giglioli, Mirandola (IT)

(73) Assignee: **Macosta Medical U.S.A., L.L.C.**,
Houston, TX (US)

(**) Term: **14 Years**

(21) Appl. No.: **29/168,996**

(22) Filed: **Oct. 11, 2002**

(51) **LOC (7) Cl.** **19-08**

(52) **U.S. Cl.** **D20/27**

(58) **Field of Search** D20/10, 13, 15,
D20/17, 22, 27, 28-29, 39-42, 99; D12/193;
40/299.01, 316, 330, 549, 606.18, 606.19,
607.13, 611.05, 612, 624, 642.01, 651;
362/812; D24/108, 112

(56) **References Cited**

U.S. PATENT DOCUMENTS

D71,038 S	*	9/1926	Underwood	D20/17
2,514,437 A	*	7/1950	Bailhe	33/713
D191,081 S	*	8/1961	Cohen	D20/41
3,525,493 A	*	8/1970	Newell et al.	248/220.21
D248,340 S	*	6/1978	Miller	D20/17
D257,562 S	*	11/1980	Smith	D20/27

4,601,255 A	*	7/1986	Marcotti	116/173
4,656,767 A	*	4/1987	Tarrant	40/316
D321,913 S	*	11/1991	Wolff	D20/27
D325,400 S	*	4/1992	Wolff	D20/42
D360,229 S	*	7/1995	Caulk	D20/41
D375,978 S	*	11/1996	Fitzgerald	D20/10
5,971,436 A	*	10/1999	Cox	283/81

* cited by examiner

Primary Examiner—Robert M. Spear
(74) *Attorney, Agent, or Firm*—Fitch, Even, Tabin & Flannery

(57) **CLAIM**

The ornamental design for a tag for intravenous infusion systems, as shown and described.

DESCRIPTION

FIG. 1 is a perspective view of a tag for intravenous infusion systems showing our new design;
FIG. 2 is a perspective view of the tag;
FIG. 3 is a top plan view thereof;
FIG. 4 is a front elevation view thereof;
FIG. 5 is a rear elevation view thereof;
FIG. 6 is a left-hand side elevation view thereof;
FIG. 7 is a right-hand side elevation view thereof; and,
FIG. 8 is a bottom plan view thereof.

The broken lines in the drawings represent environmental structure only and form no part of the claimed design.

1 Claim, 2 Drawing Sheets

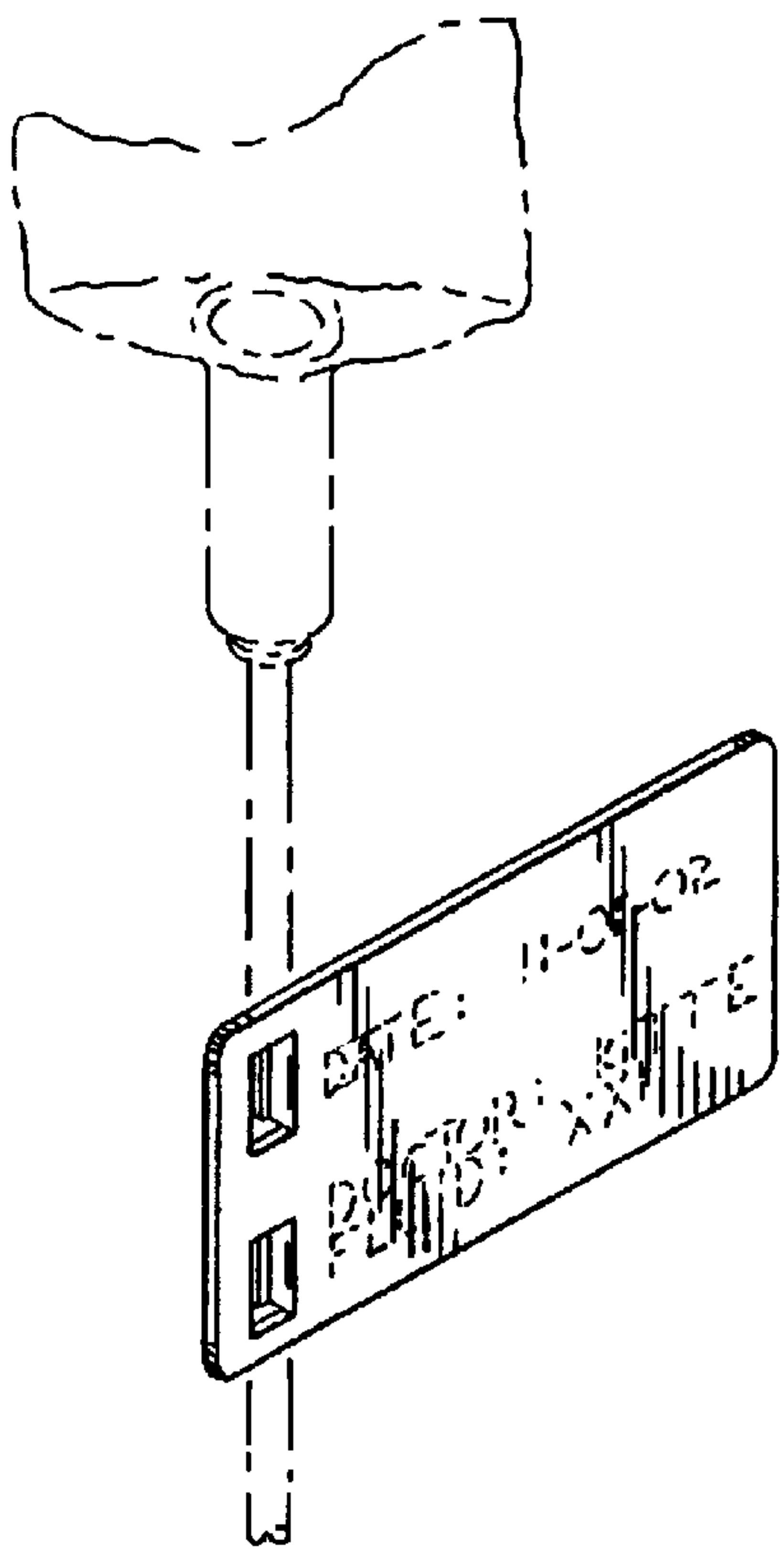

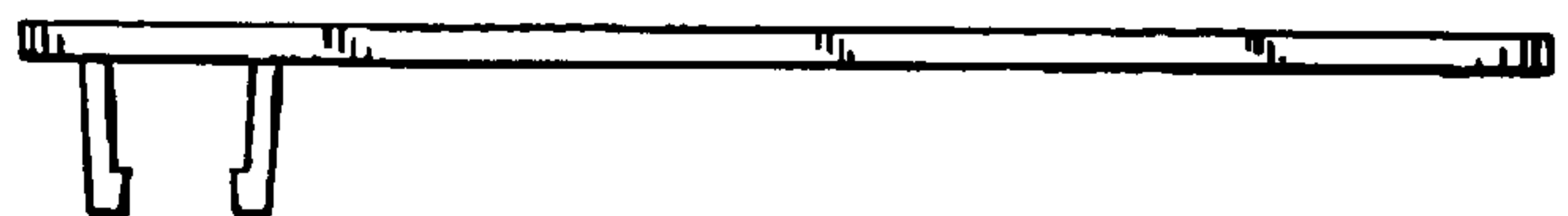
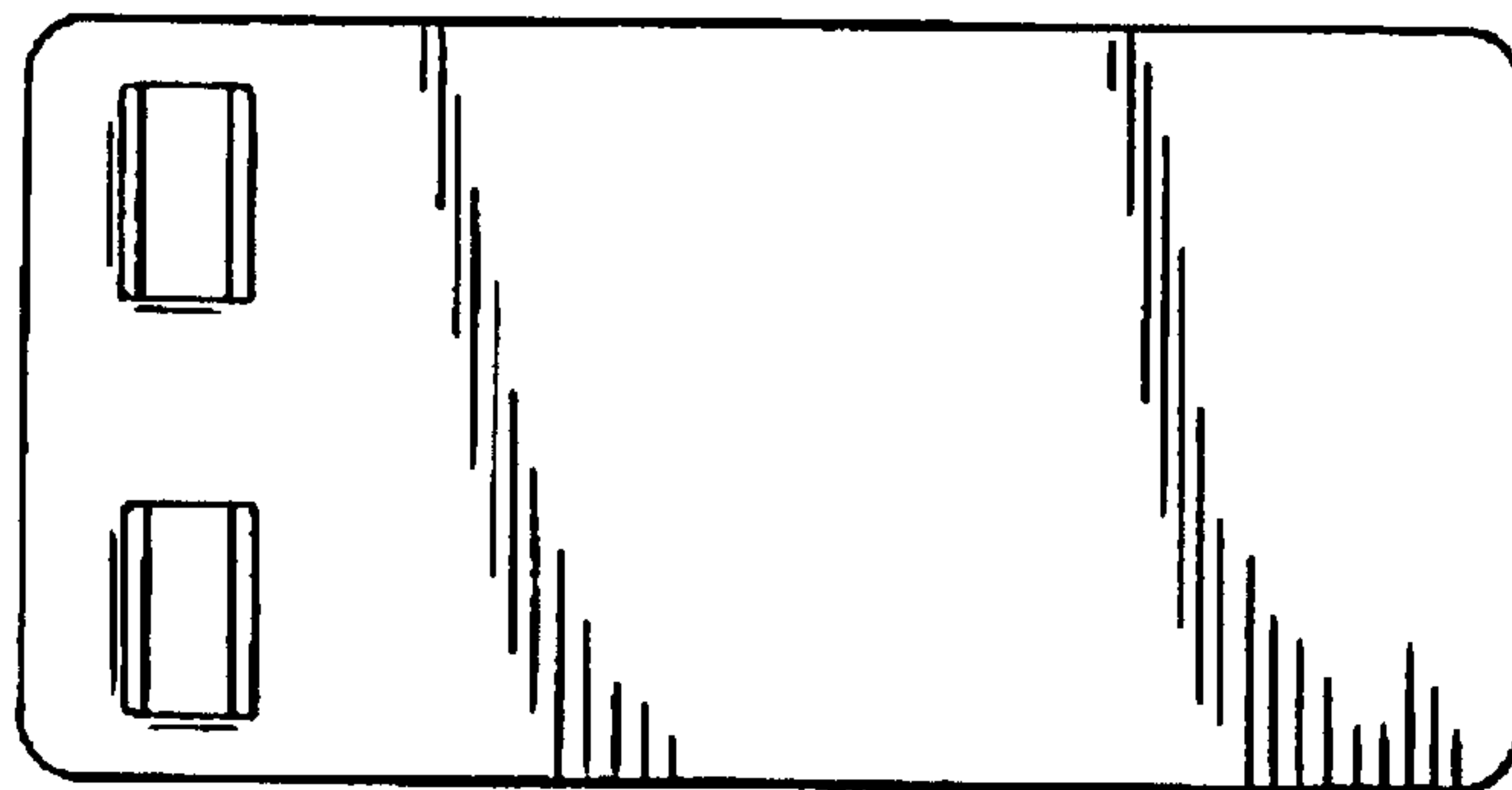
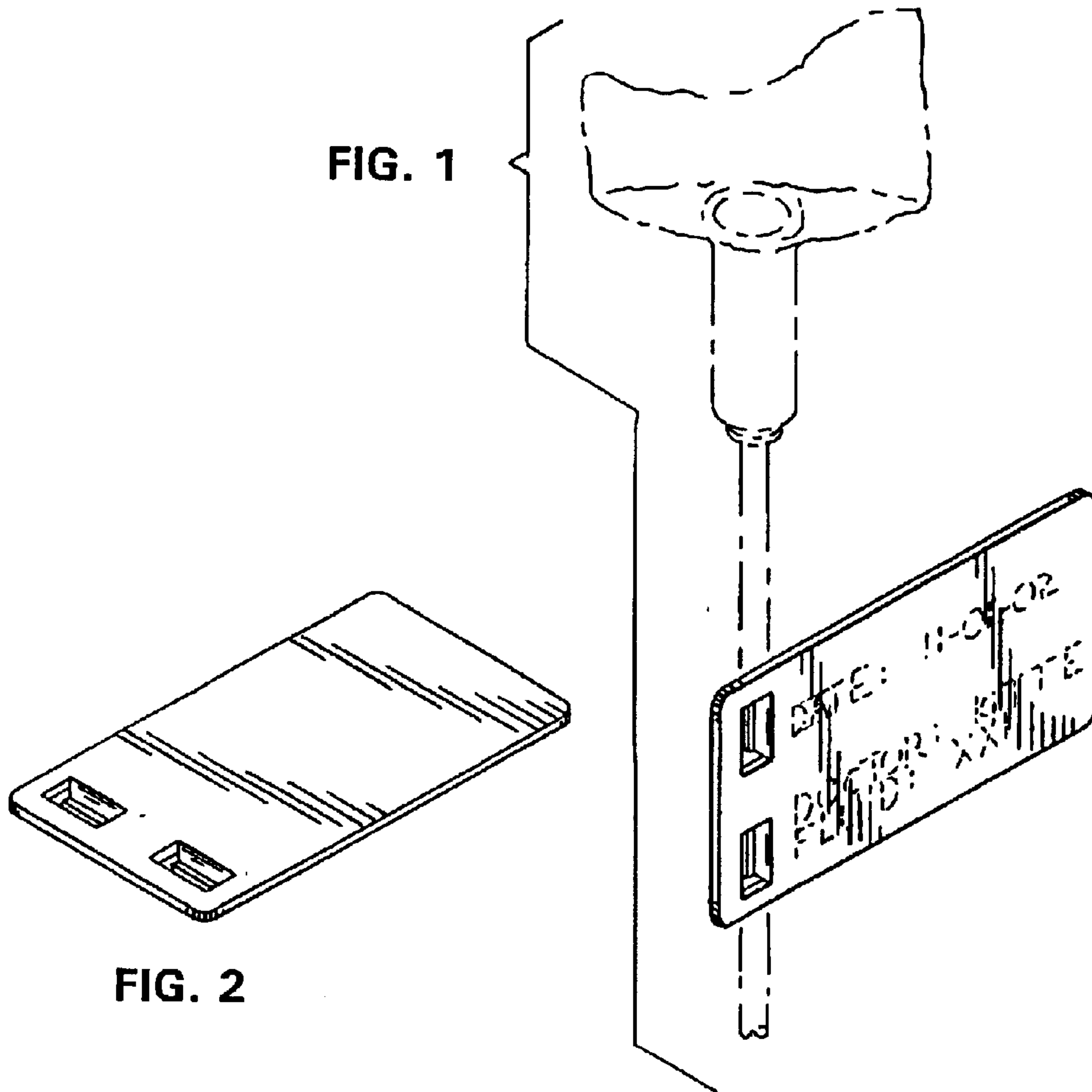

FIG. 4

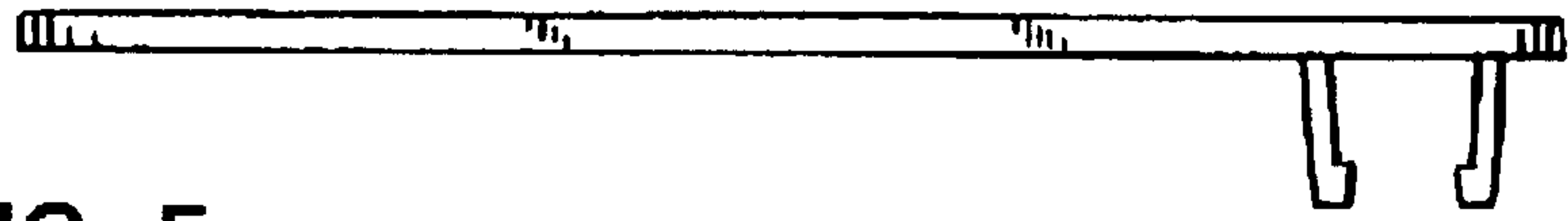

FIG. 5

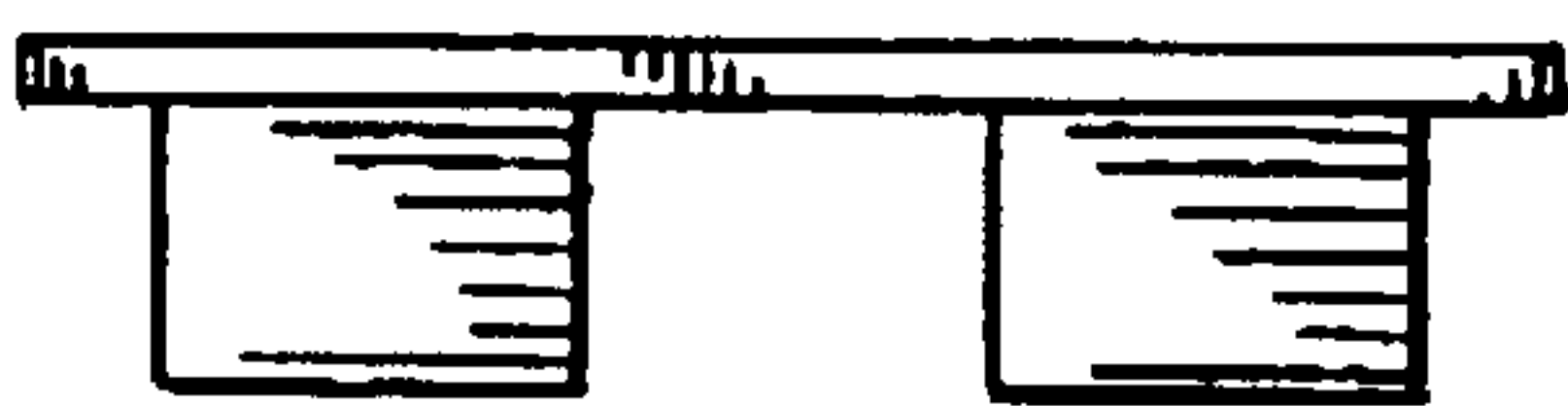

FIG. 6

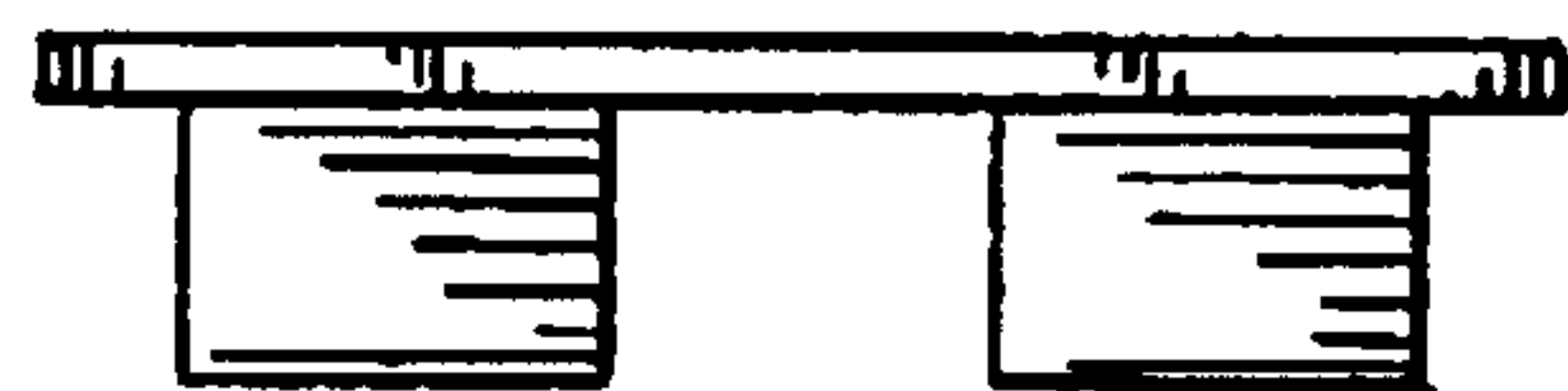

FIG. 7

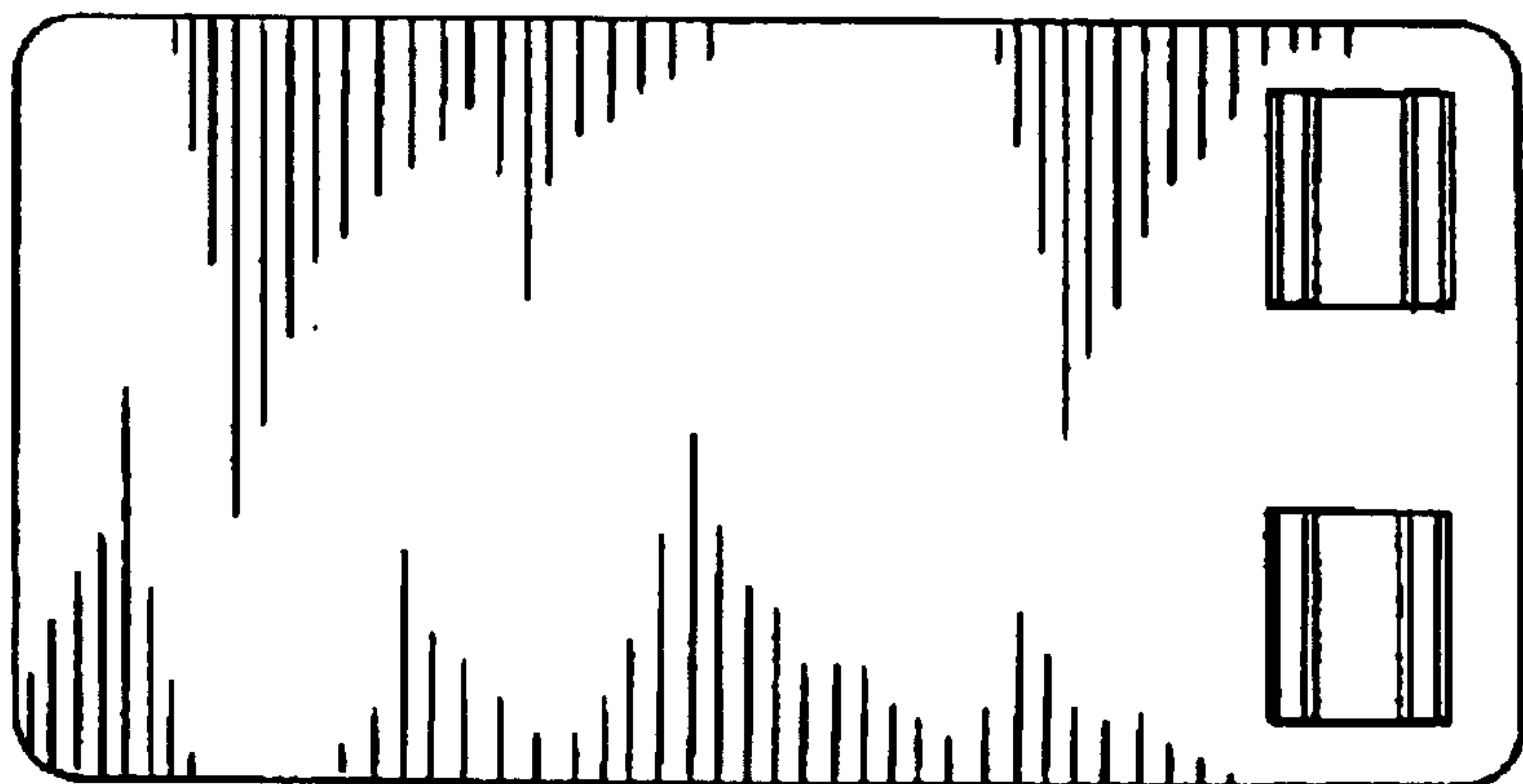

FIG. 8