



US00D490065S

(12) **United States Design Patent**
Shimazu et al.

(10) **Patent No.:** **US D490,065 S**

(45) **Date of Patent:** **** May 18, 2004**

(54) **PORTABLE TELEPHONE**

(75) Inventors: **Masao Shimazu**, Hiroshima-ken (JP);
Hirokazu Machide, Hiroshima-ken (JP)

(73) Assignee: **Sharp Kabushiki Kaisha (JP)**

(**) Term: **14 Years**

(21) Appl. No.: **29/189,414**

(22) Filed: **Sep. 5, 2003**

(30) **Foreign Application Priority Data**

Mar. 7, 2003 (JP) 2003-005944

(51) **LOC (7) Cl.** **14-03**

(52) **U.S. Cl.** **D14/138**

(58) **Field of Search** D14/137, 138,
D14/218, 147-148, 247-248, 144, 341-347;
379/433.01-433.13, 419, 434, 428.01-428.04,
420.01-420.04, 440; 455/550.1-90.3; D21/517;
D13/168; D18/2, 7; 345/168, 169

(56) **References Cited**

U.S. PATENT DOCUMENTS

D445,412 S	*	7/2001	Lee et al.	D14/138
D456,378 S		4/2002	Fujimoto	D14/138
D458,594 S	*	6/2002	Jang	D14/138
D459,330 S	*	6/2002	Suzuki et al.	D14/138
D465,466 S	*	11/2002	Hyun	D14/138
D468,283 S	*	1/2003	Hong et al.	D14/138
D475,688 S	*	6/2003	Pierce et al.	D14/138
D475,689 S		6/2003	Shimazu et al.	D14/138
D476,635 S	*	7/2003	Nagai et al.	D14/138
D476,968 S	*	7/2003	Yokoyama	D14/138
D477,294 S	*	7/2003	Ikeda et al.	D14/138
D477,296 S	*	7/2003	Minamide	D14/138
D477,581 S	*	7/2003	Iijima et al.	D14/138

D481,696 S	*	11/2003	Wei et al.	D14/138
D484,478 S	*	12/2003	Kota et al.	D14/138
D484,863 S	*	1/2004	Chan	D14/138
D485,248 S	*	1/2004	Ogawa	D14/138

FOREIGN PATENT DOCUMENTS

JP	1153260	*	9/2002	
JP	1155098	*	10/2002	
JP	2002360331 A	*	12/2002 A45C/13/30

* cited by examiner

Primary Examiner—Jeffrey Asch

(74) *Attorney, Agent, or Firm*—Nixon & Vanderhye P.C.

(57) **CLAIM**

The ornamental design for a “portable telephone”, as shown and described.

DESCRIPTION

FIG. 1 is a top, front and right side perspective view of a portable telephone according to our design;
 FIG. 2 is a front elevational view thereof;
 FIG. 3 is a rear elevational view thereof;
 FIG. 4 is a top plan view thereof;
 FIG. 5 is a bottom plan view thereof;
 FIG. 6 is a right side elevational view thereof;
 FIG. 7 is a left side elevational view thereof;
 FIG. 8 is a top, front and right side perspective view of the portable telephone hereof in an open position;
 FIG. 9 is a front elevational view thereof;
 FIG. 10 is a rear elevational view thereof;
 FIG. 11 is a top plan view thereof;
 FIG. 12 is a bottom plan view thereof;
 FIG. 13 is a right side elevational view thereof; and,
 FIG. 14 is a left side elevational view thereof.

1 Claim, 9 Drawing Sheets

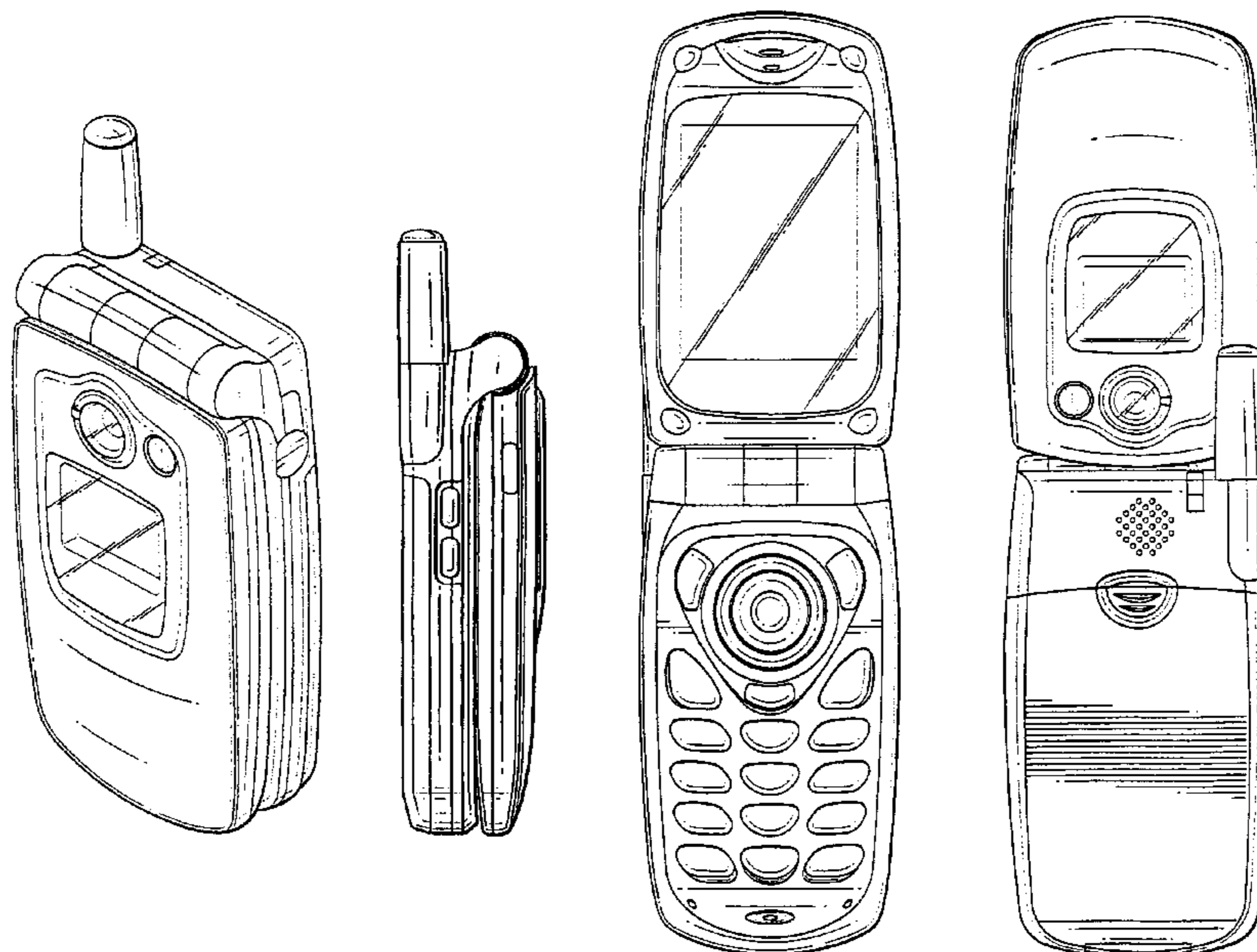

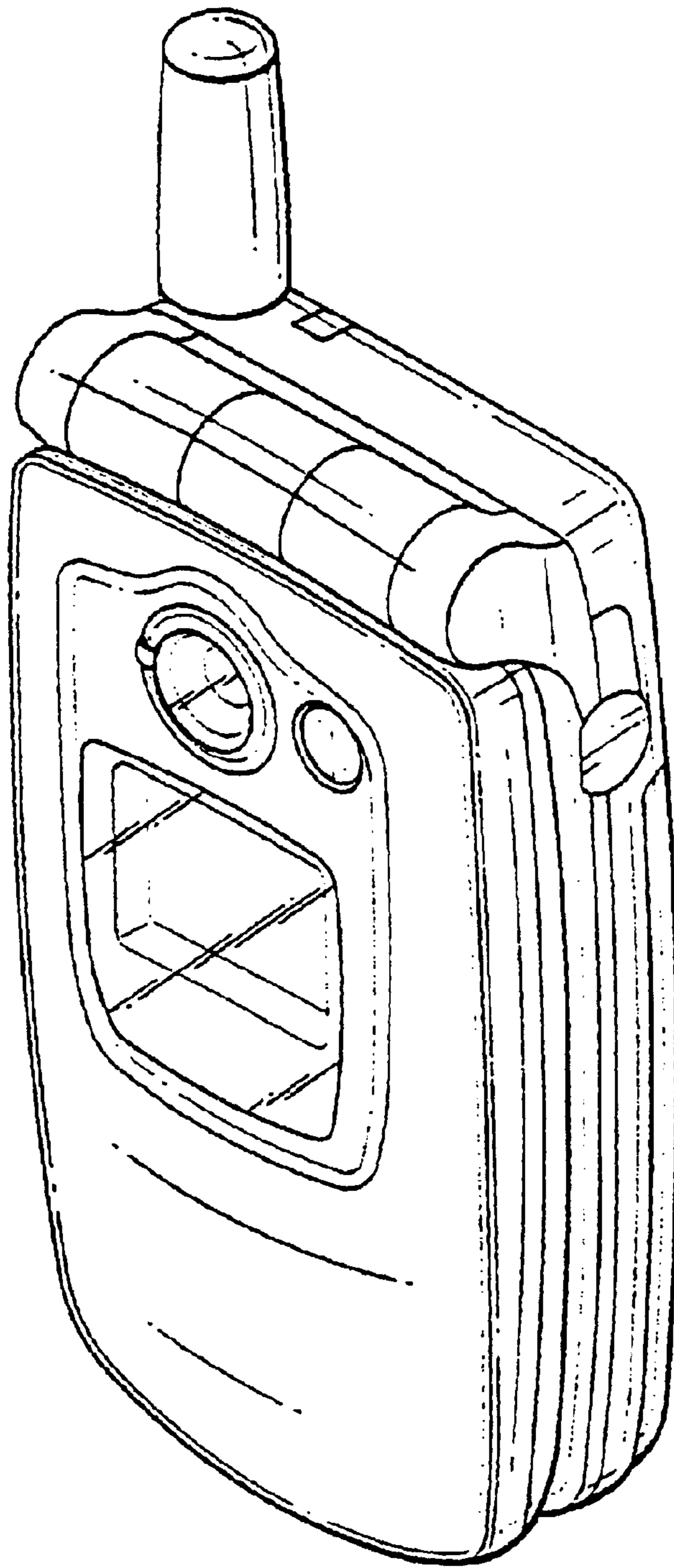

Fig. 1

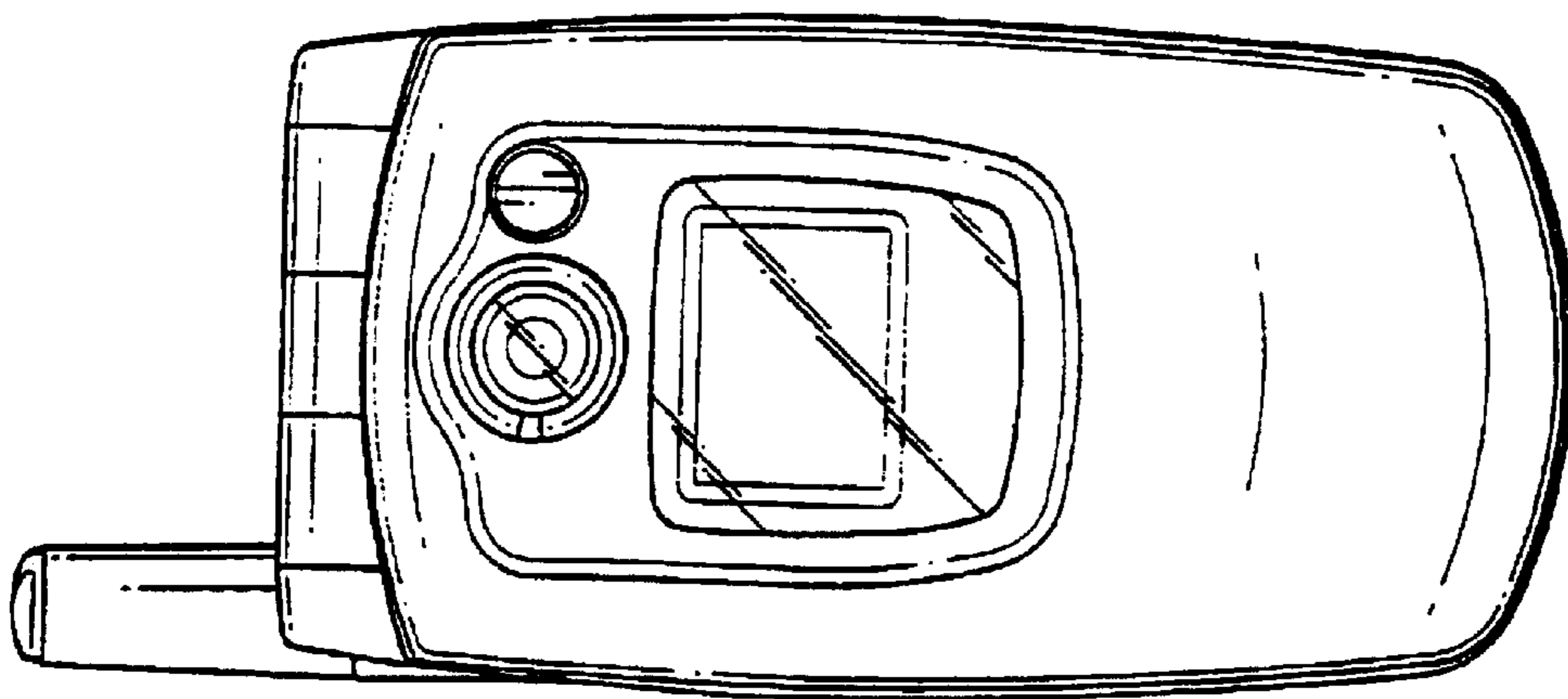

Fig. 2

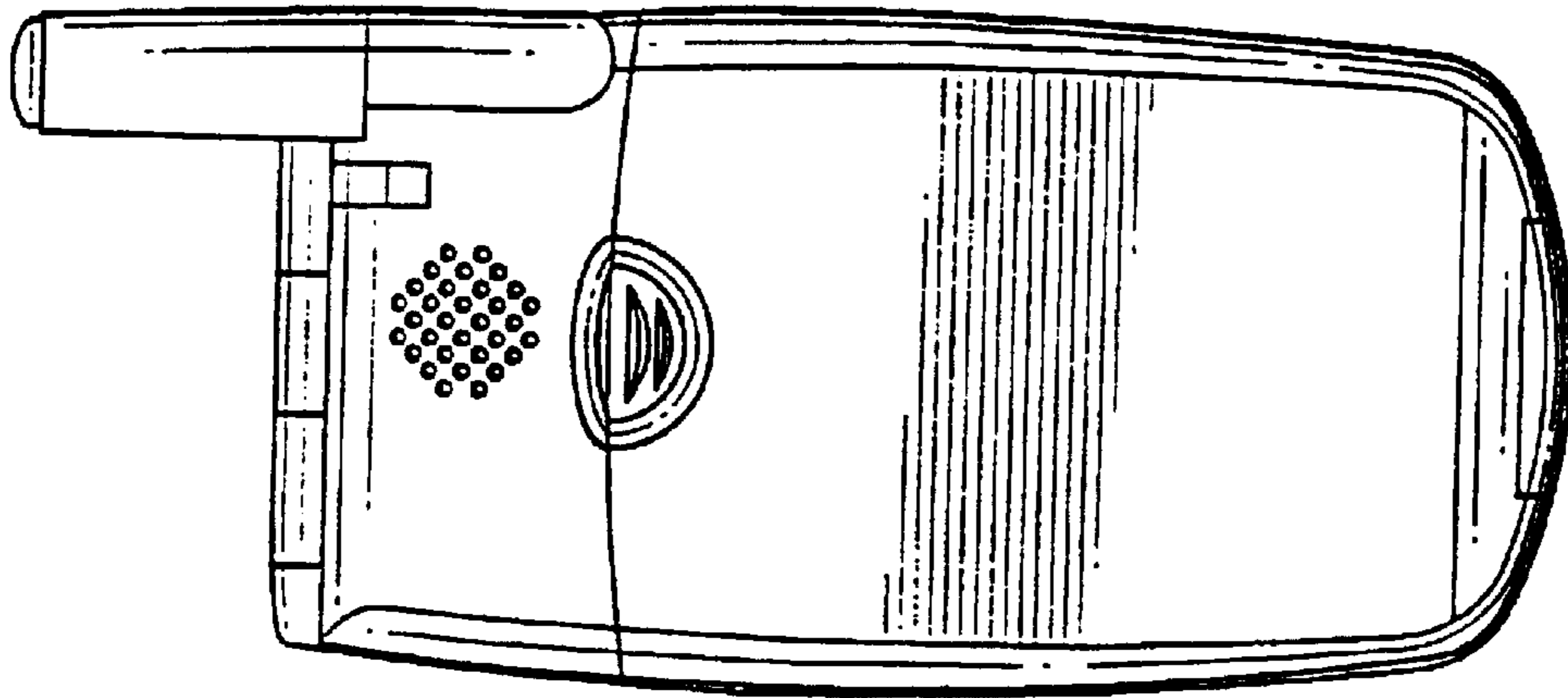

Fig. 3

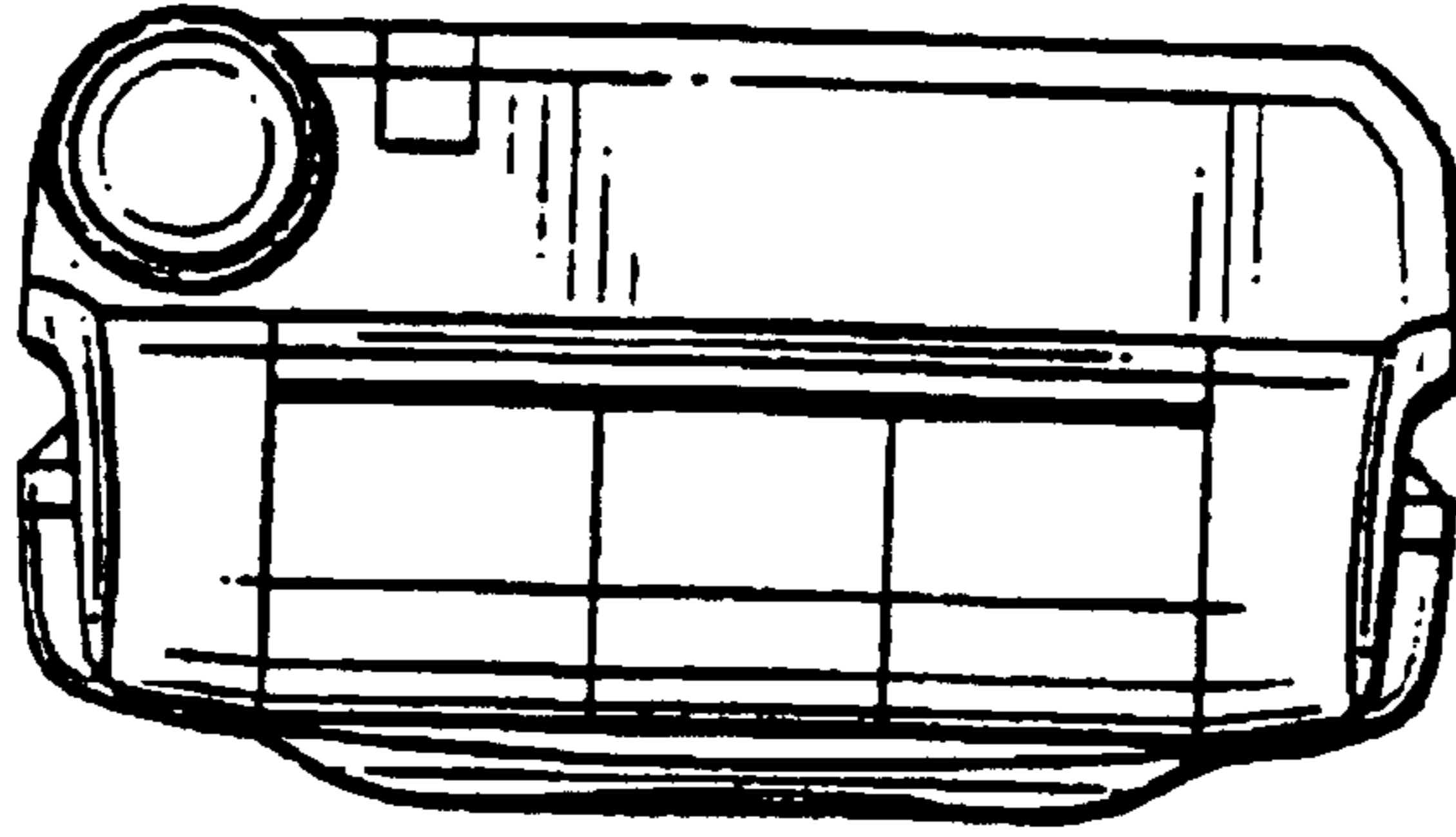

Fig. 4

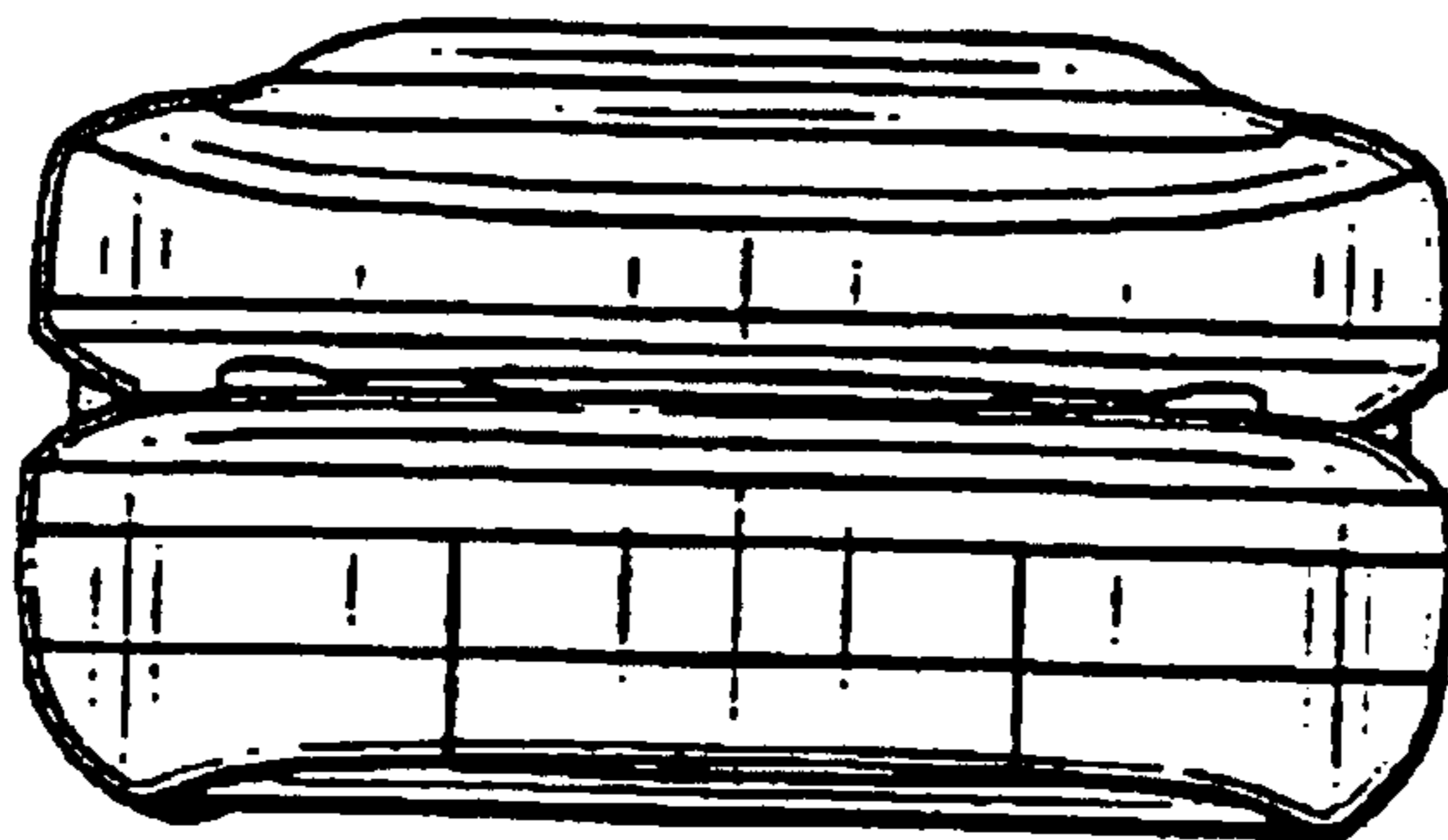

Fig. 5

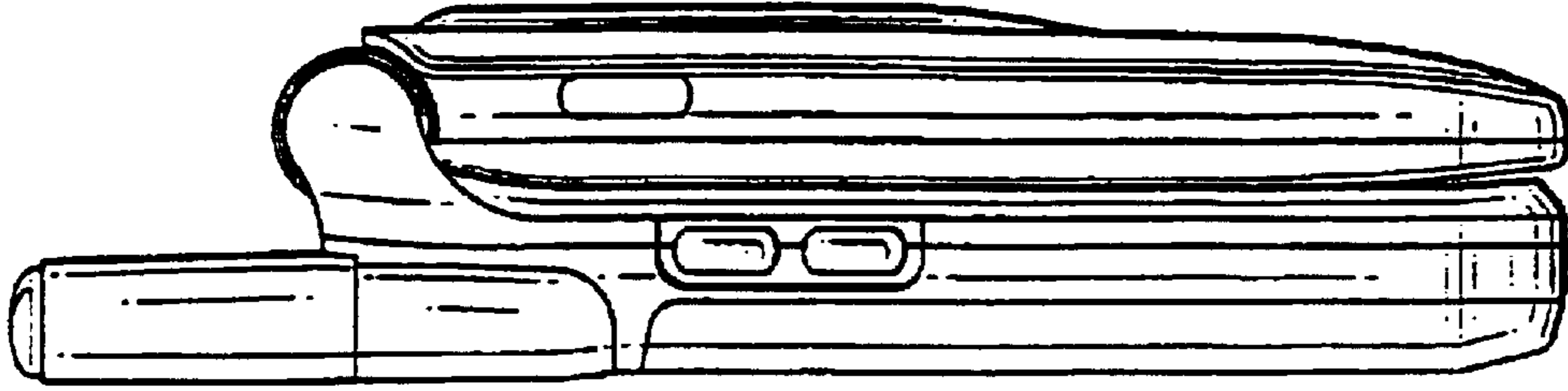

Fig. 7

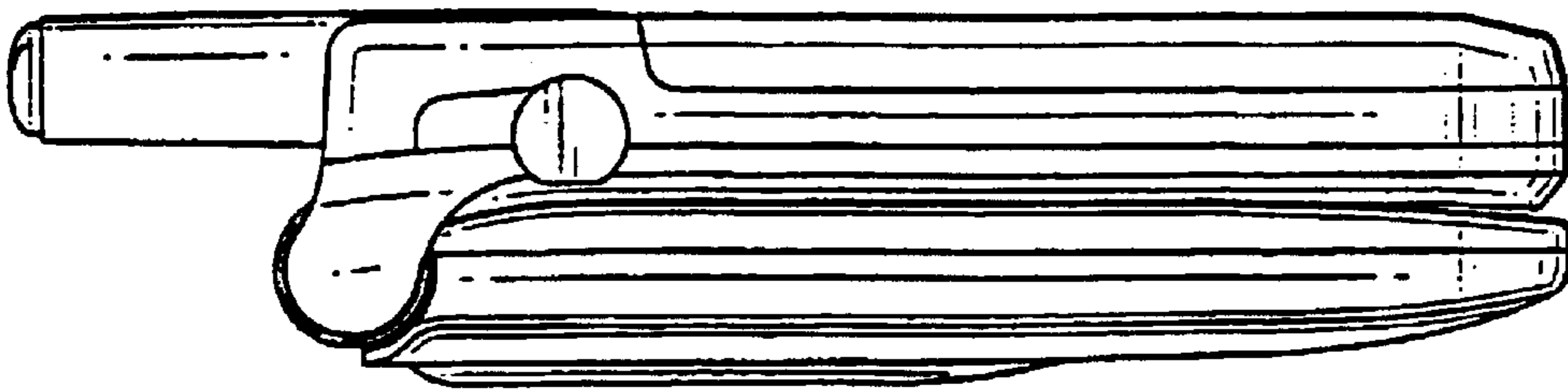

Fig. 6

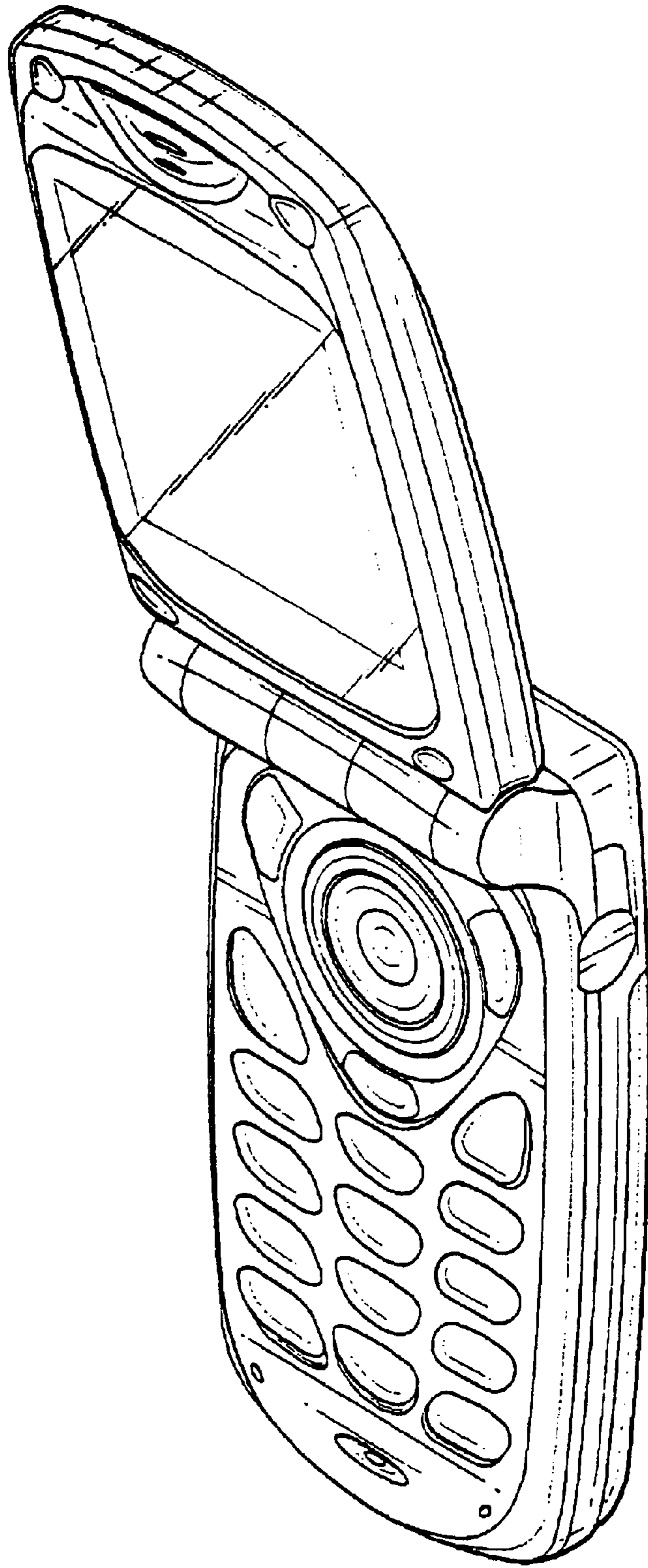

Fig. 8

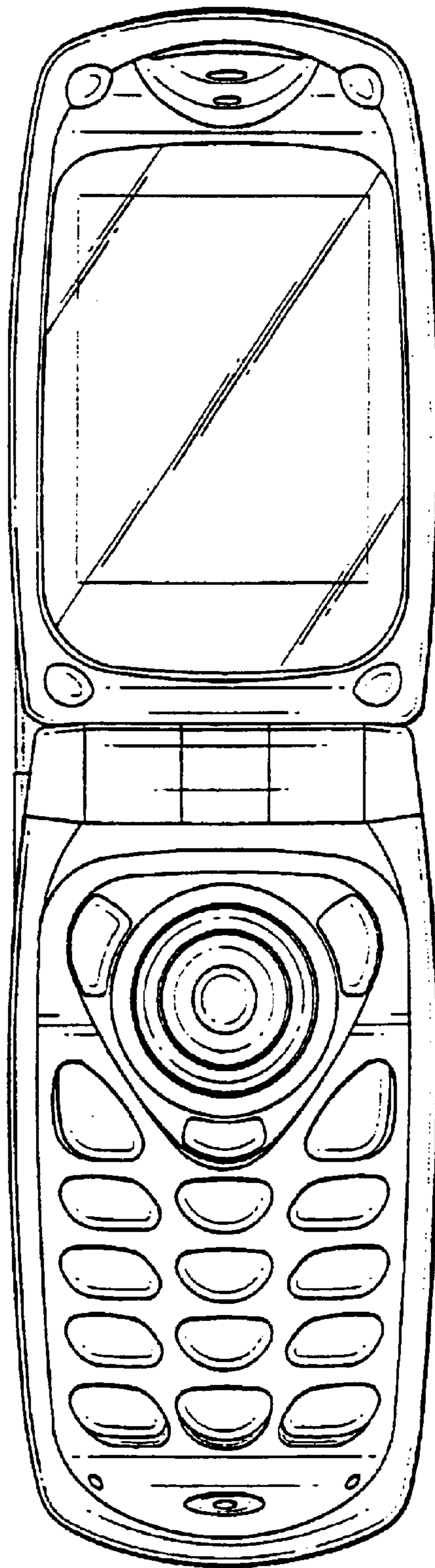

Fig. 9

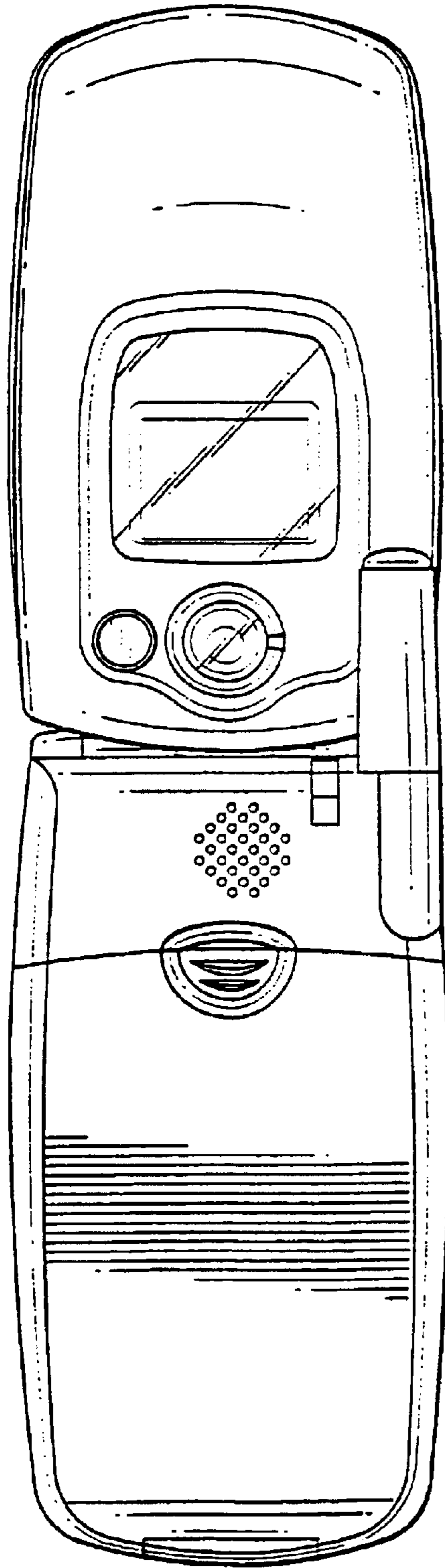

Fig. 10

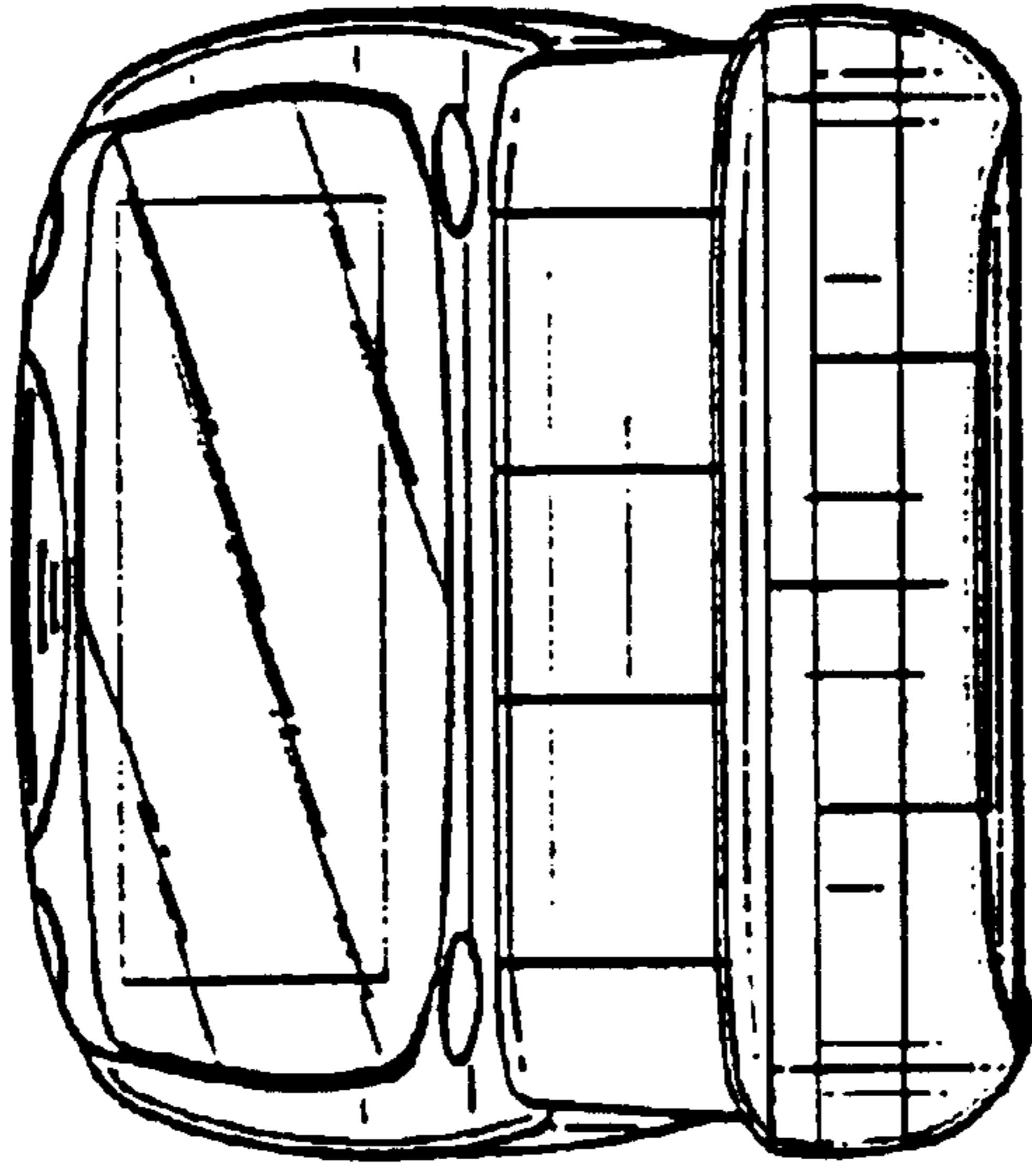

Fig. 12

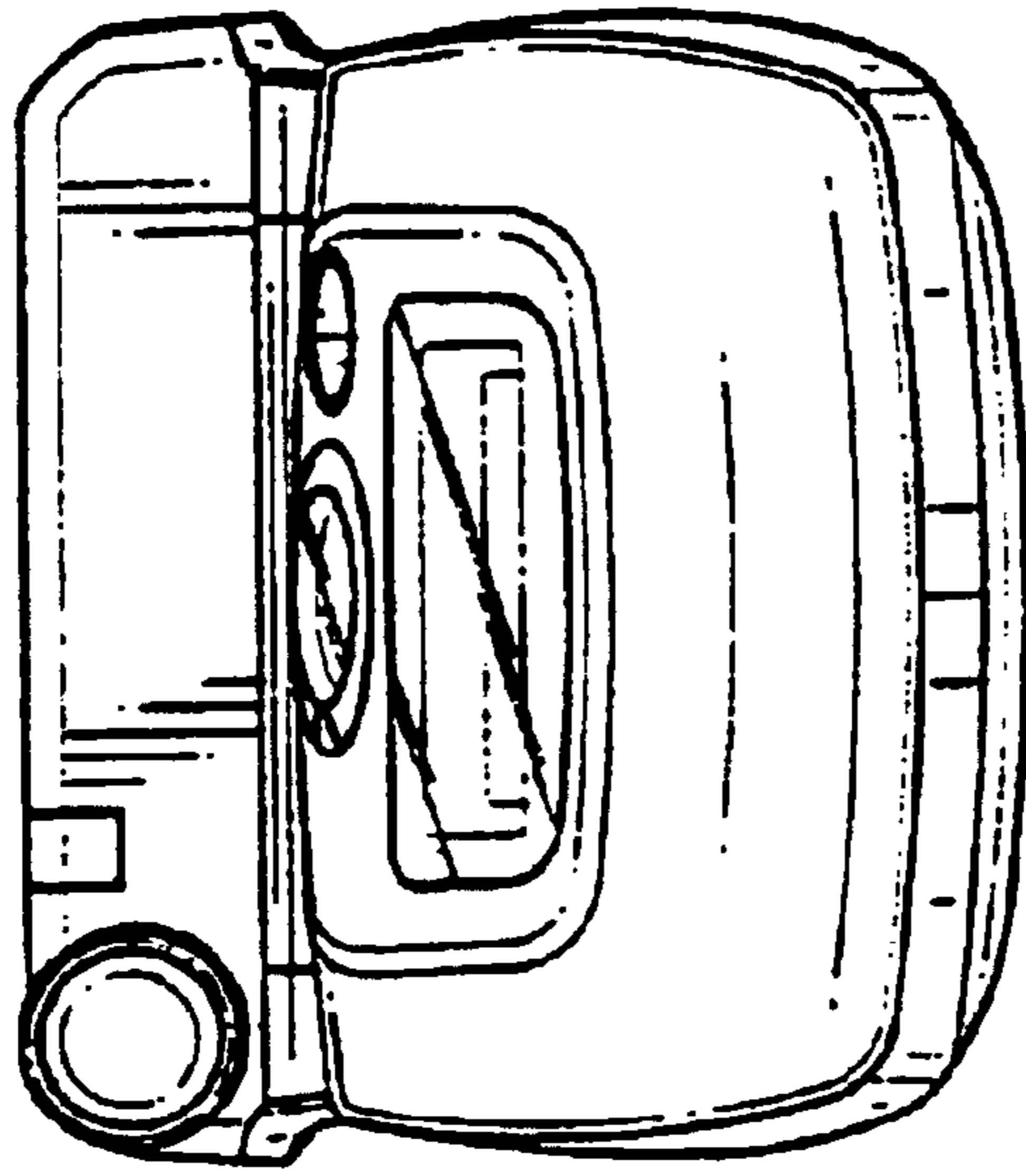

Fig. 11

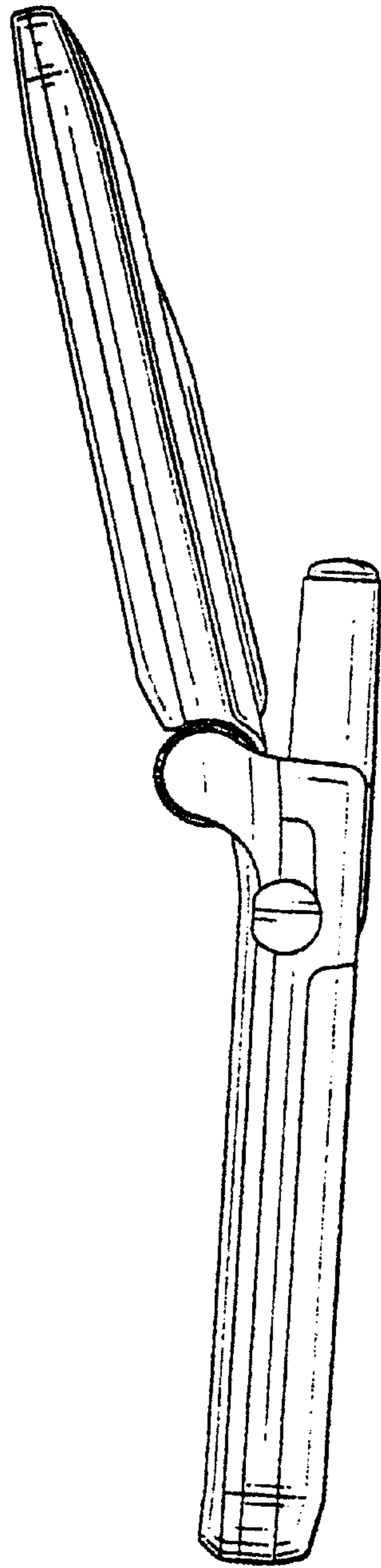

Fig. 13

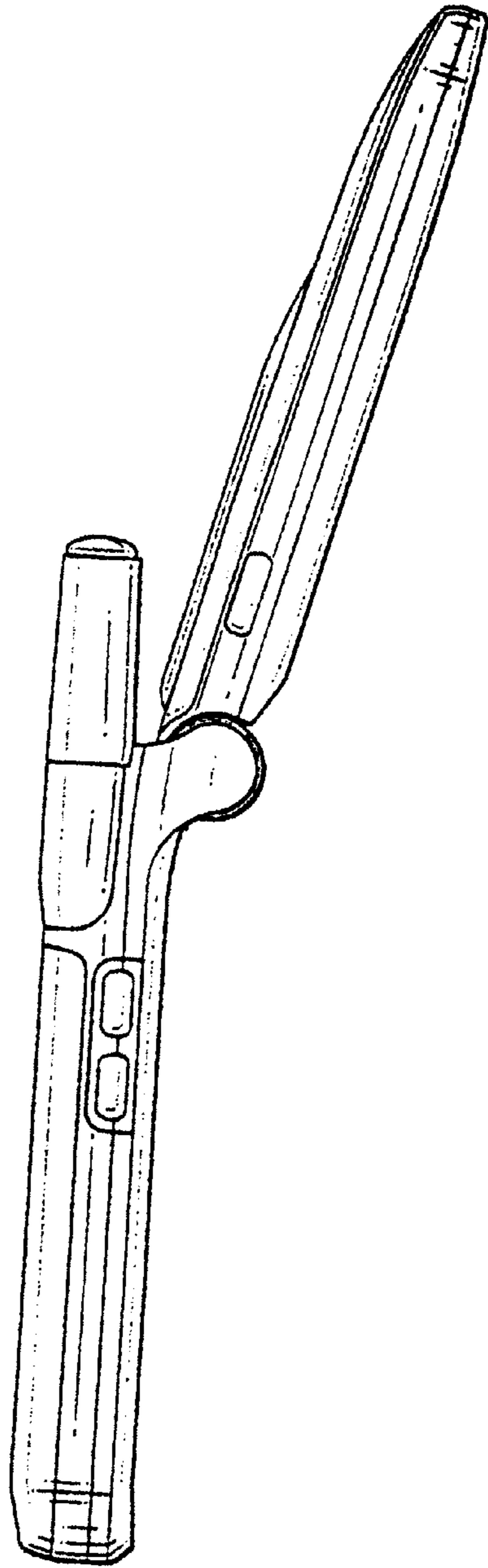

Fig. 14