



US00D489801S

(12) **United States Design Patent**  
**Shimizu**

(10) **Patent No.:** **US D489,801 S**

(45) **Date of Patent:** **\*\* May 11, 2004**

(54) **AIR PURIFIER**

(57) **CLAIM**

The ornamental design for an air purifier, as shown and described.

(75) **Inventor:** **Hisashi Shimizu, Kusatsu (JP)**

**DESCRIPTION**

(73) **Assignee:** **Daikin Industries Ltd., Osaka (JP)**

FIG. 1 is a perspective view of an air purifier showing my new design;

(\*\*) **Term:** **14 Years**

FIG. 2 is a front view thereof;

(21) **Appl. No.:** **29/180,272**

FIG. 3 is a rear view thereof;

(22) **Filed:** **Apr. 22, 2003**

FIG. 4 is a plan view thereof;

(51) **LOC (7) Cl.** ..... **23-04**

FIG. 5 is a bottom view thereof;

(52) **U.S. Cl.** ..... **D23/364**

FIG. 6 is a right side view thereof, a left side view being symmetrical to the right side view;

(58) **Field of Search** ..... D23/355, 356,  
D23/364; 96/15; 55/504, 473

FIG. 7 is a sectional view taken along line 7—7 in FIG. 2;

(56) **References Cited**

**U.S. PATENT DOCUMENTS**

FIG. 8 is a sectional view taken along line 8—8 in FIG. 2;

D379,220 S \* 5/1997 Ellwood ..... D23/364

FIG. 9 is a perspective view of a modified example of the air purifier showing my new design, a rear view thereof being identical to FIG. 3, a plan view thereof being identical to FIG. 4, a bottom view thereof being identical to FIG. 5, a right side view thereof being identical to FIG. 6, a left side view thereof being symmetrical to the right side view;

D402,746 S \* 12/1998 Clark et al. .... D23/364

FIG. 10 is a front view thereof;

D450,825 S \* 11/2001 Nakamura et al. .... D23/364

FIG. 11 is a sectional view taken along line 11—11 in FIG. 10; and,

D472,626 S \* 4/2003 Nakamura ..... D23/364

FIG. 12 is a sectional view taken along line 12—12 in FIG. 10.

\* cited by examiner

*Primary Examiner*—Robin V. Taylor

**1 Claim, 6 Drawing Sheets**

(74) *Attorney, Agent, or Firm*—Kanesaka & Takeuchi

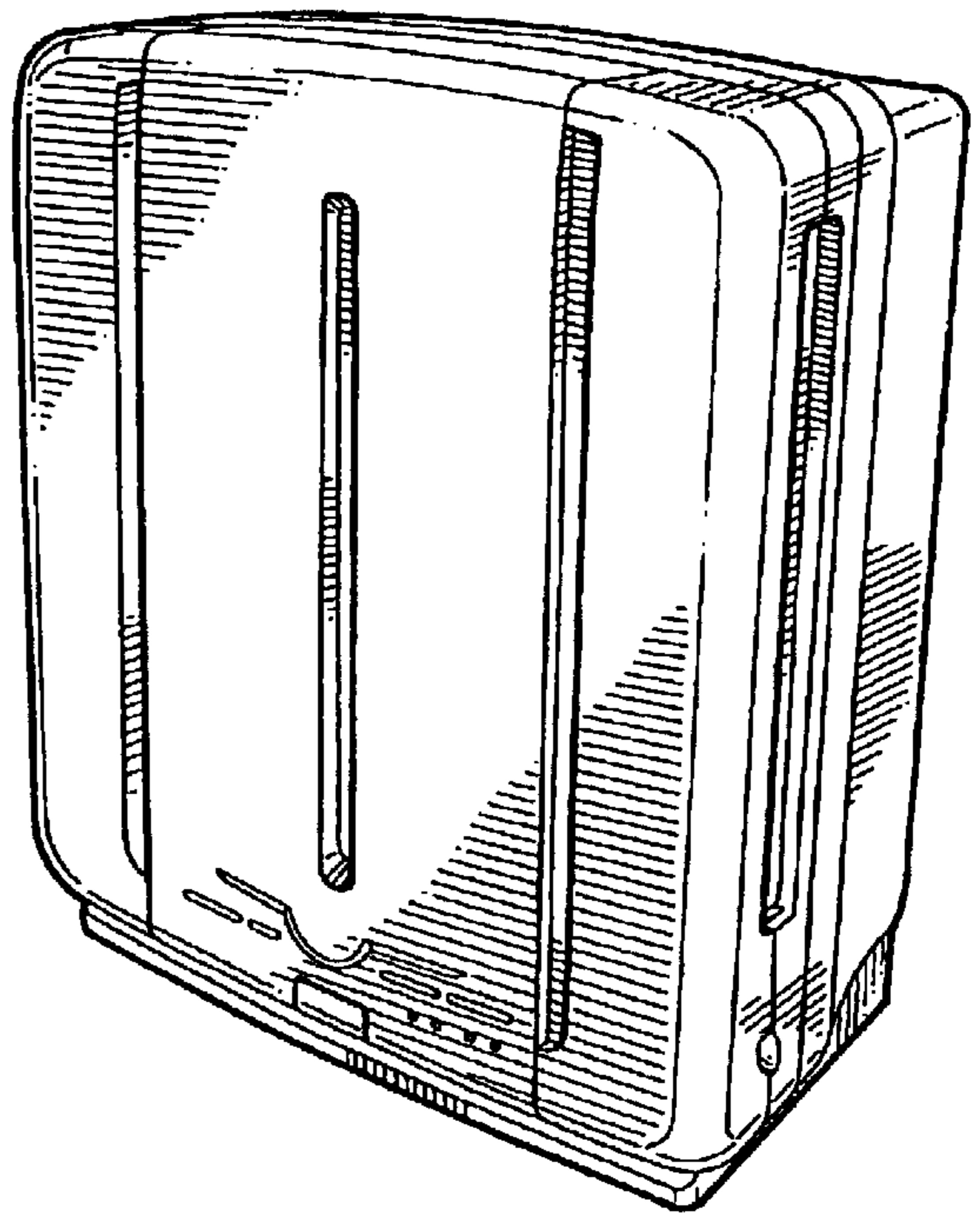
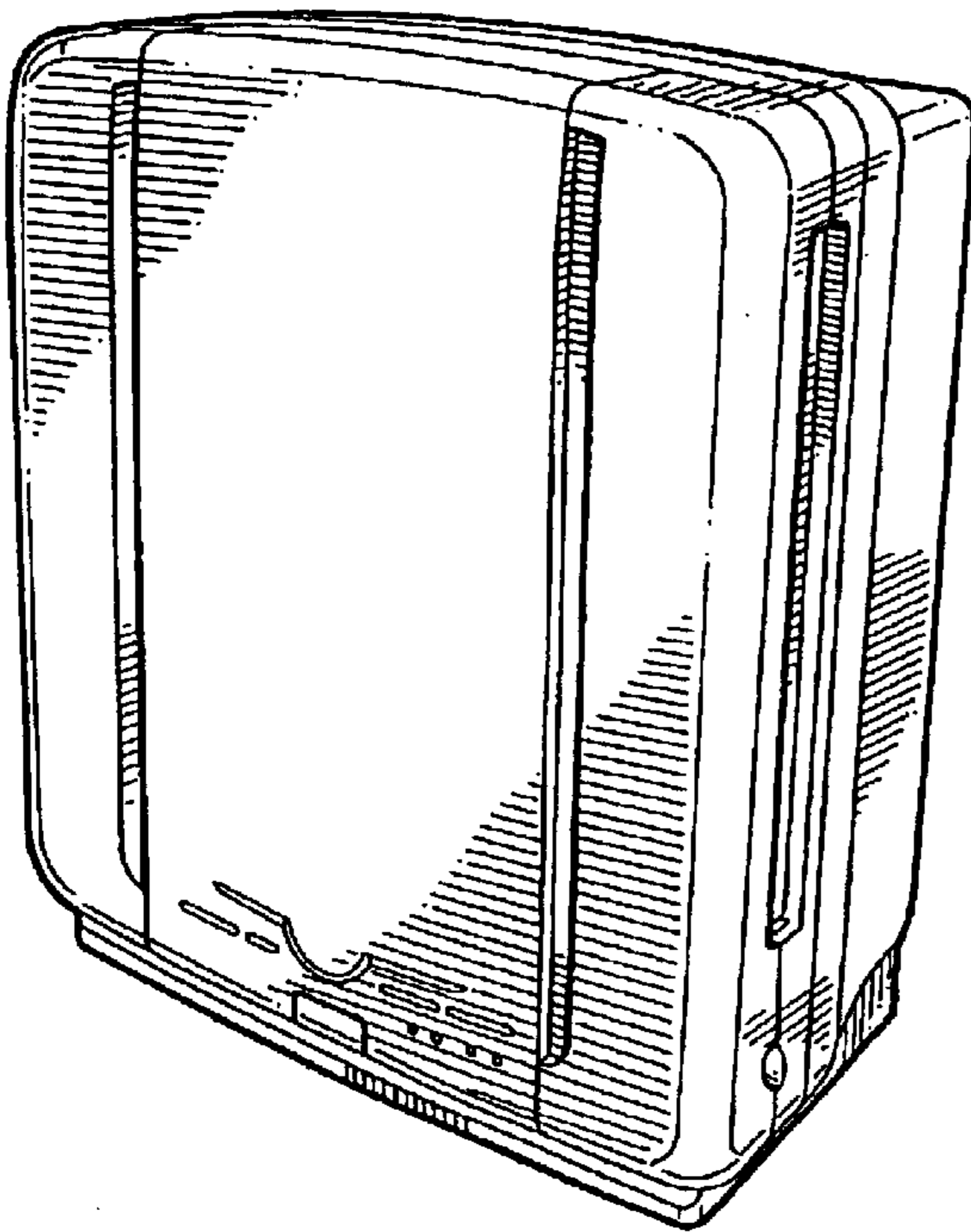

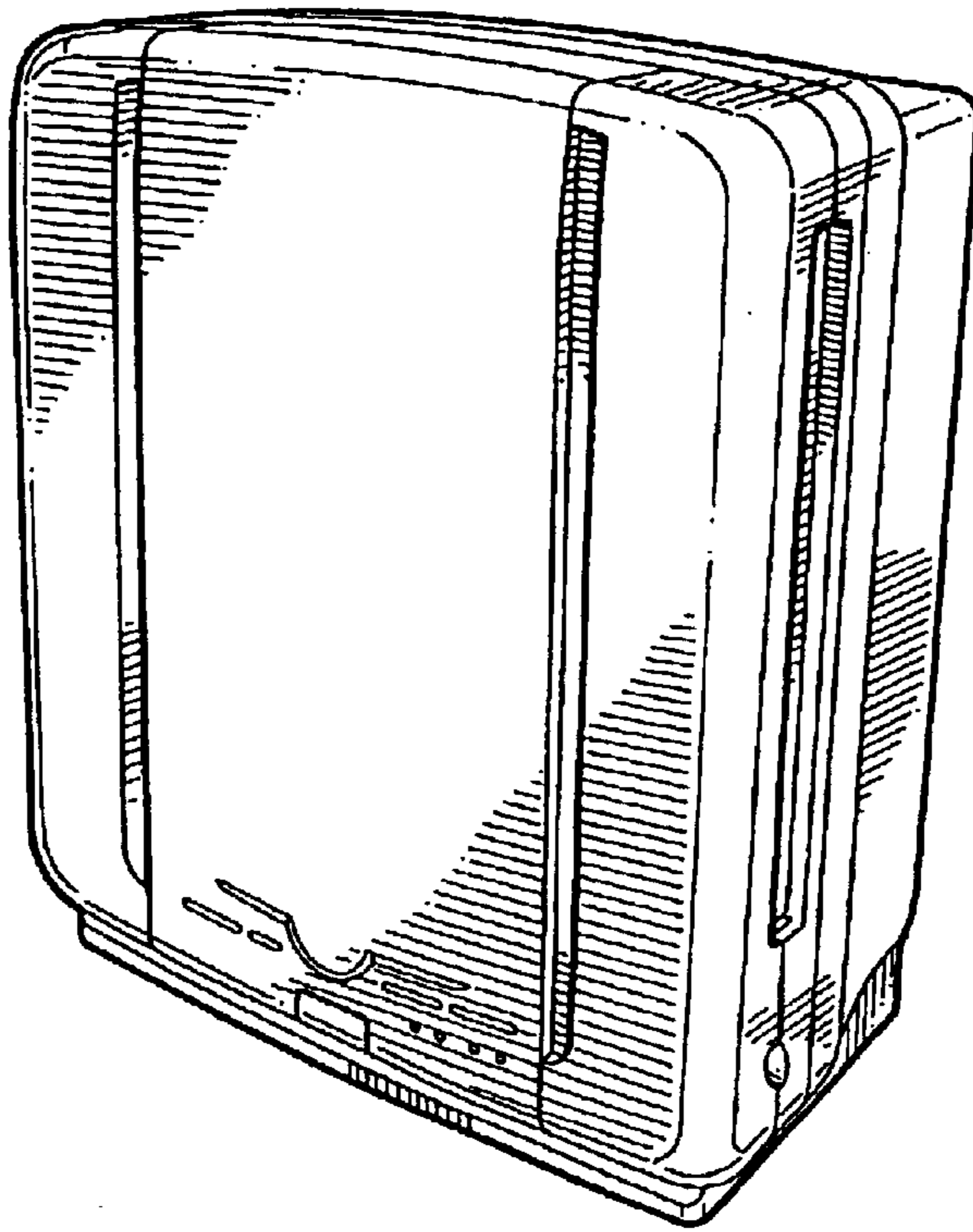
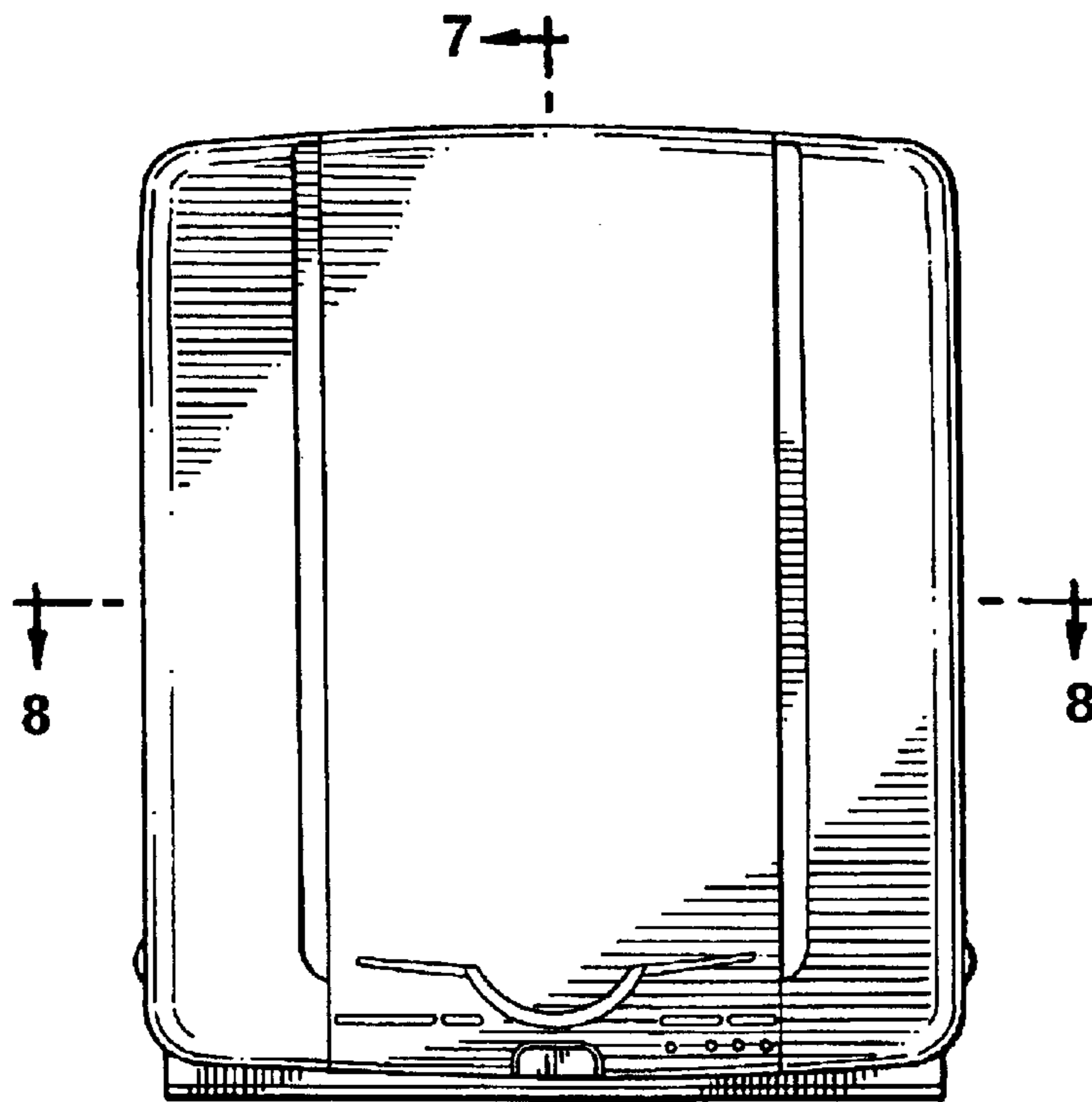

FIG. 1



7-7  
FIG. 2

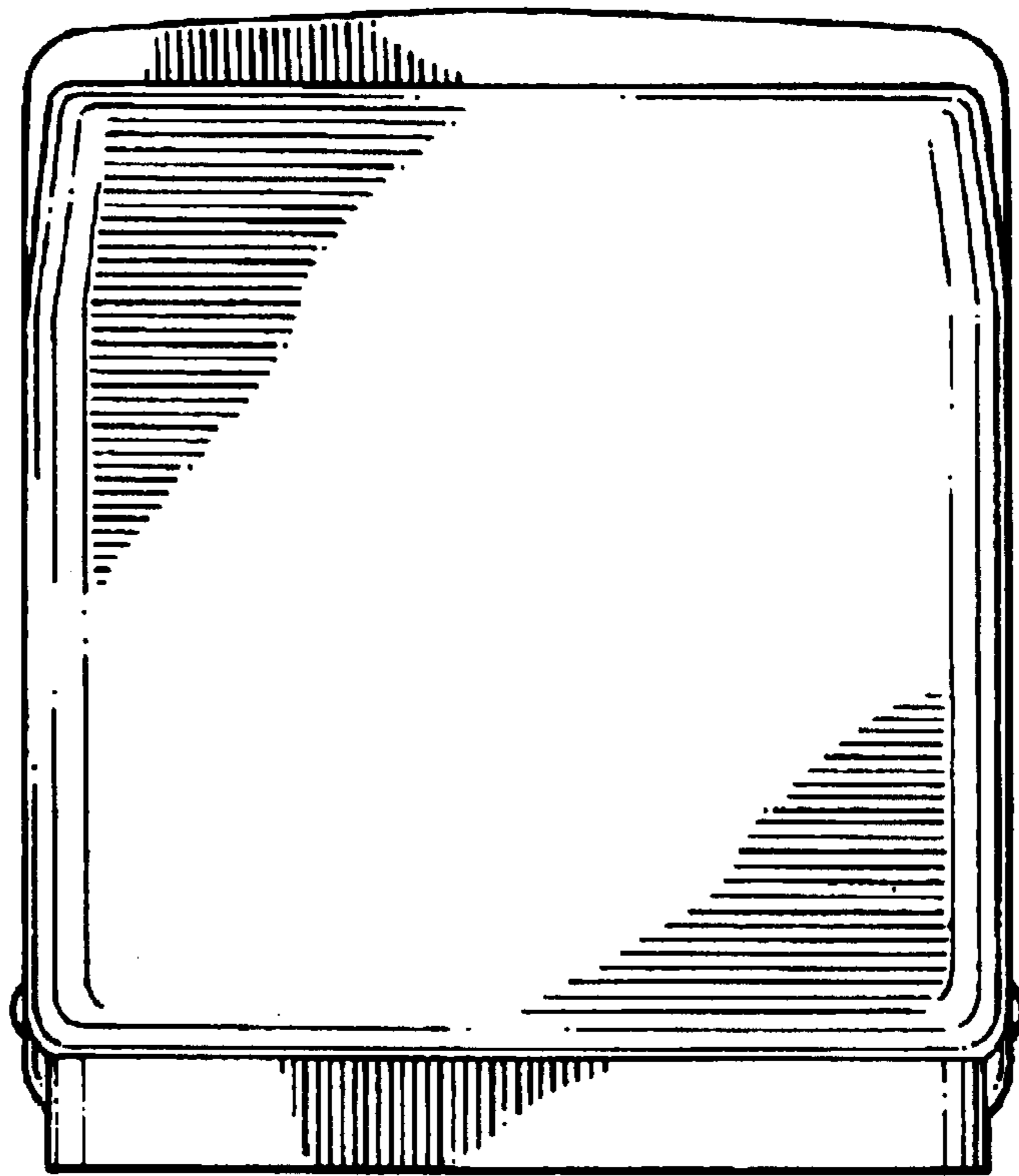

FIG. 3

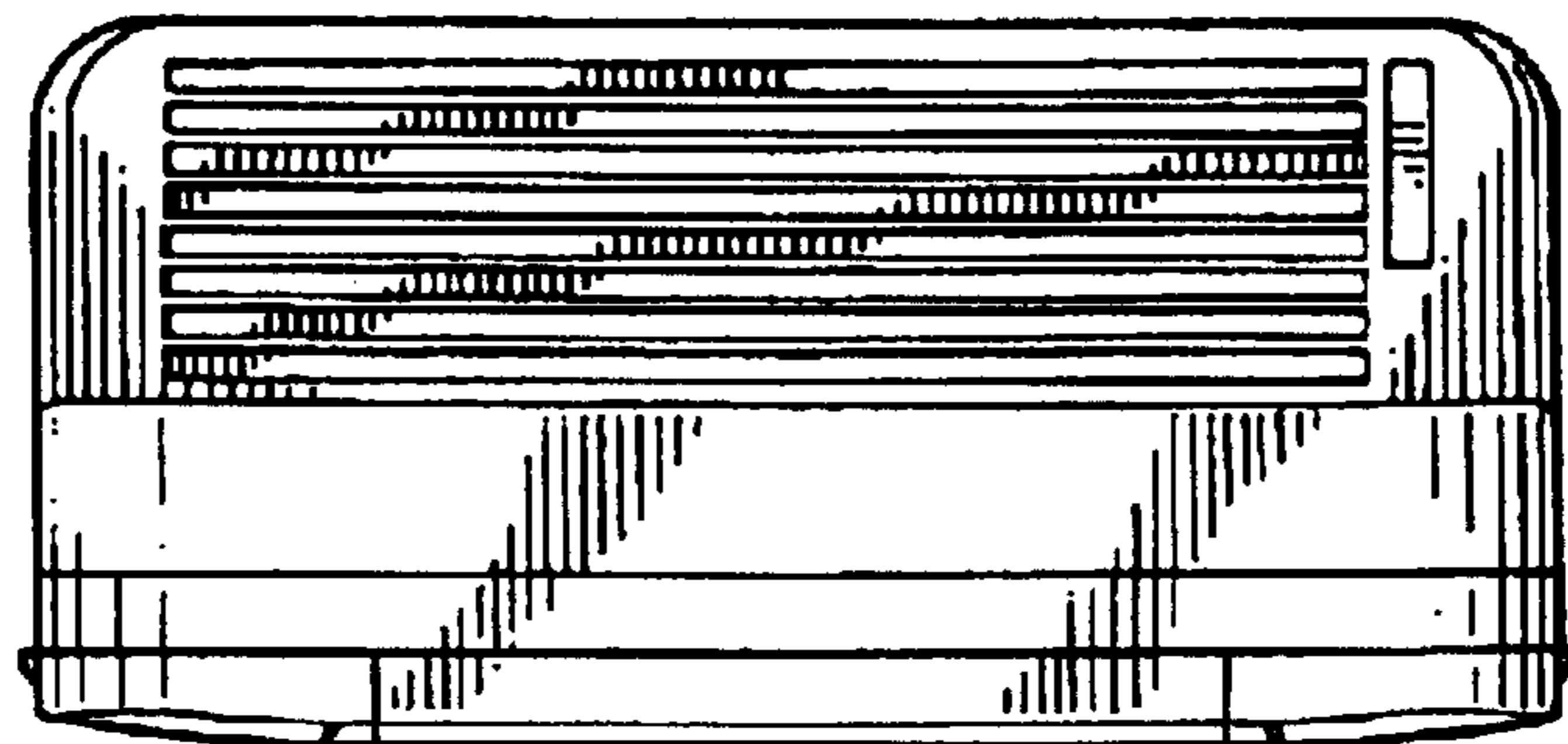

FIG. 4

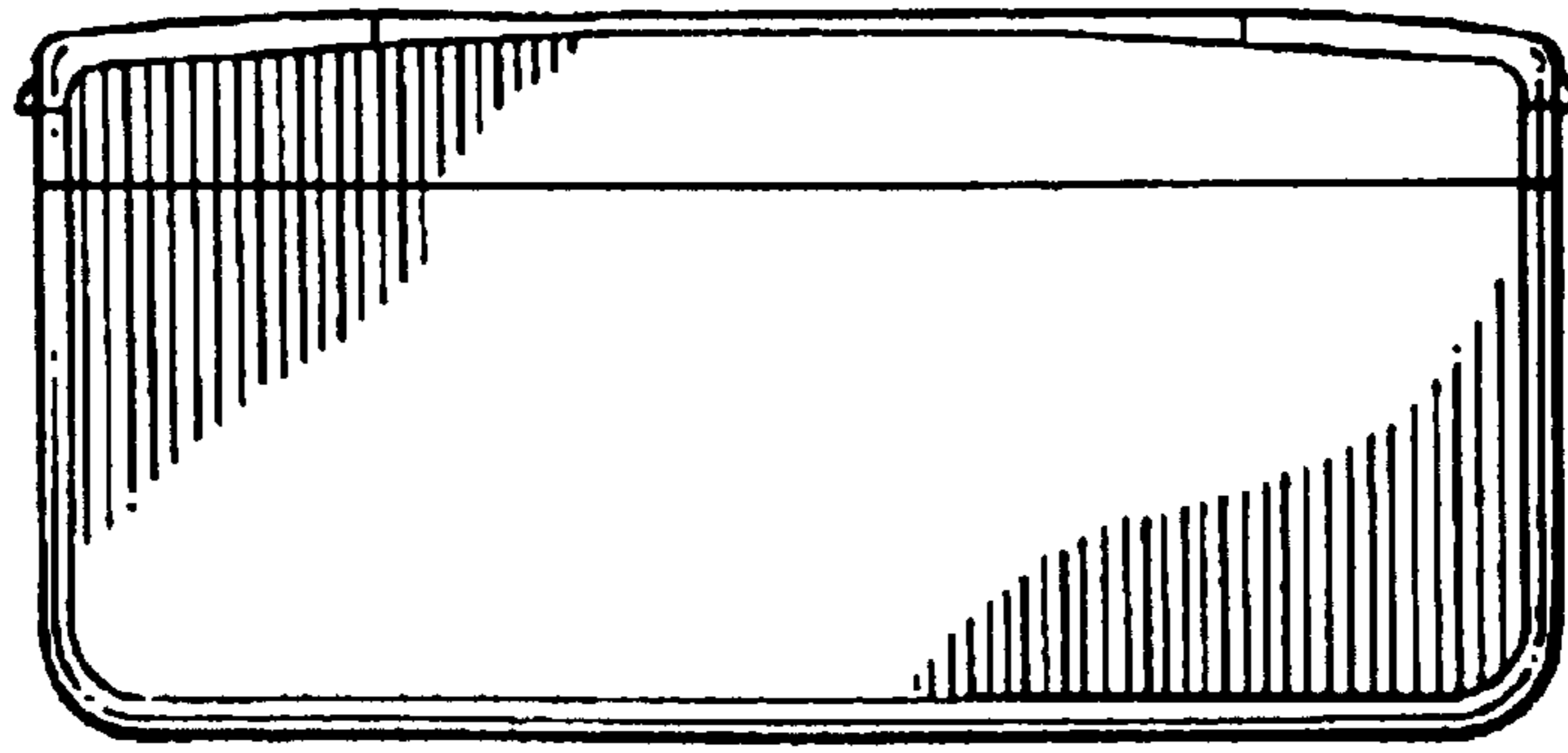

FIG. 5

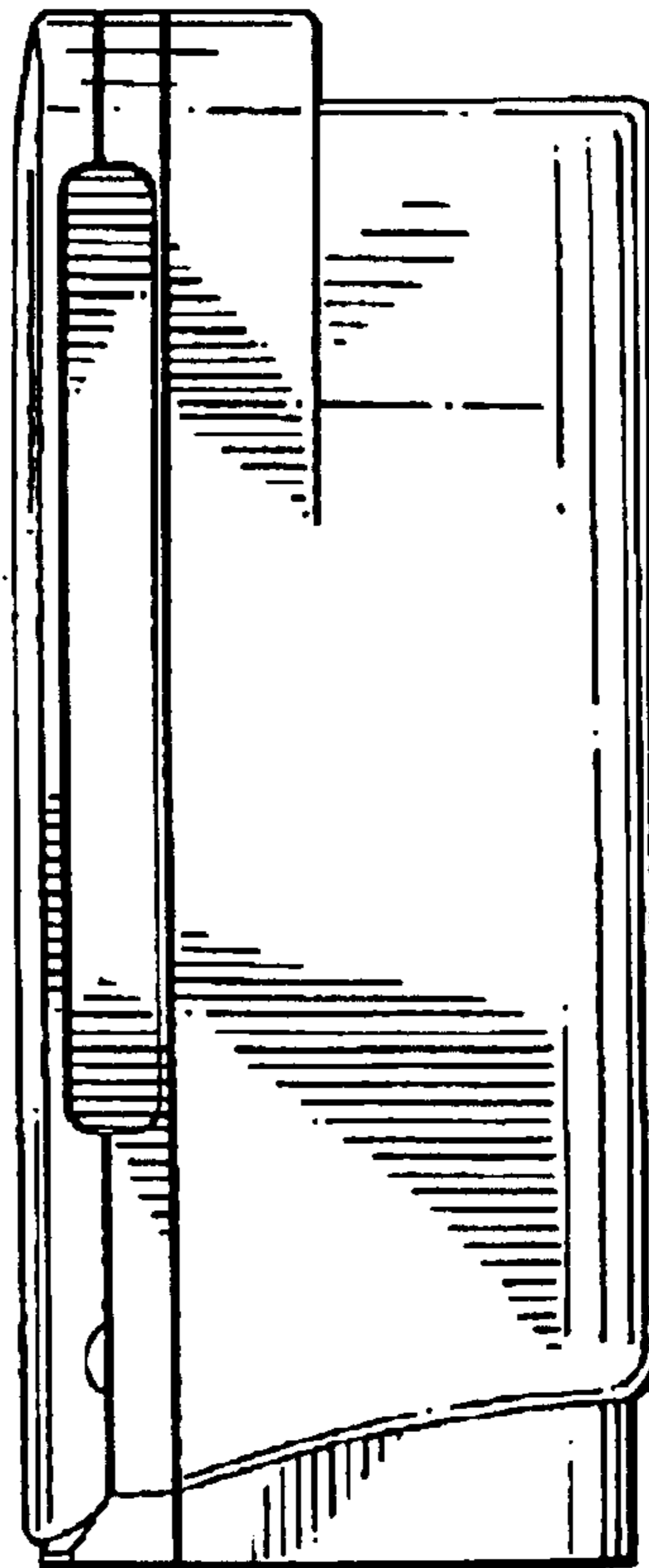

FIG. 6

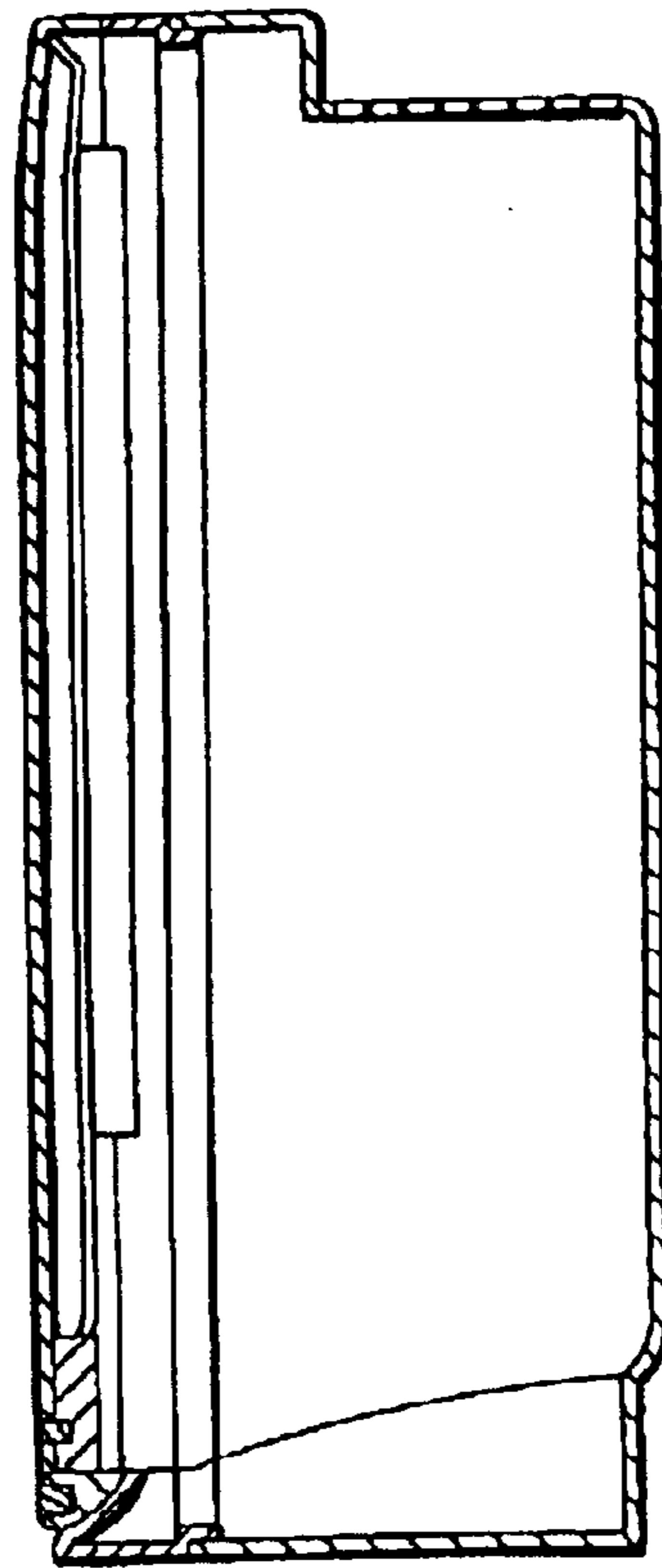

FIG. 7

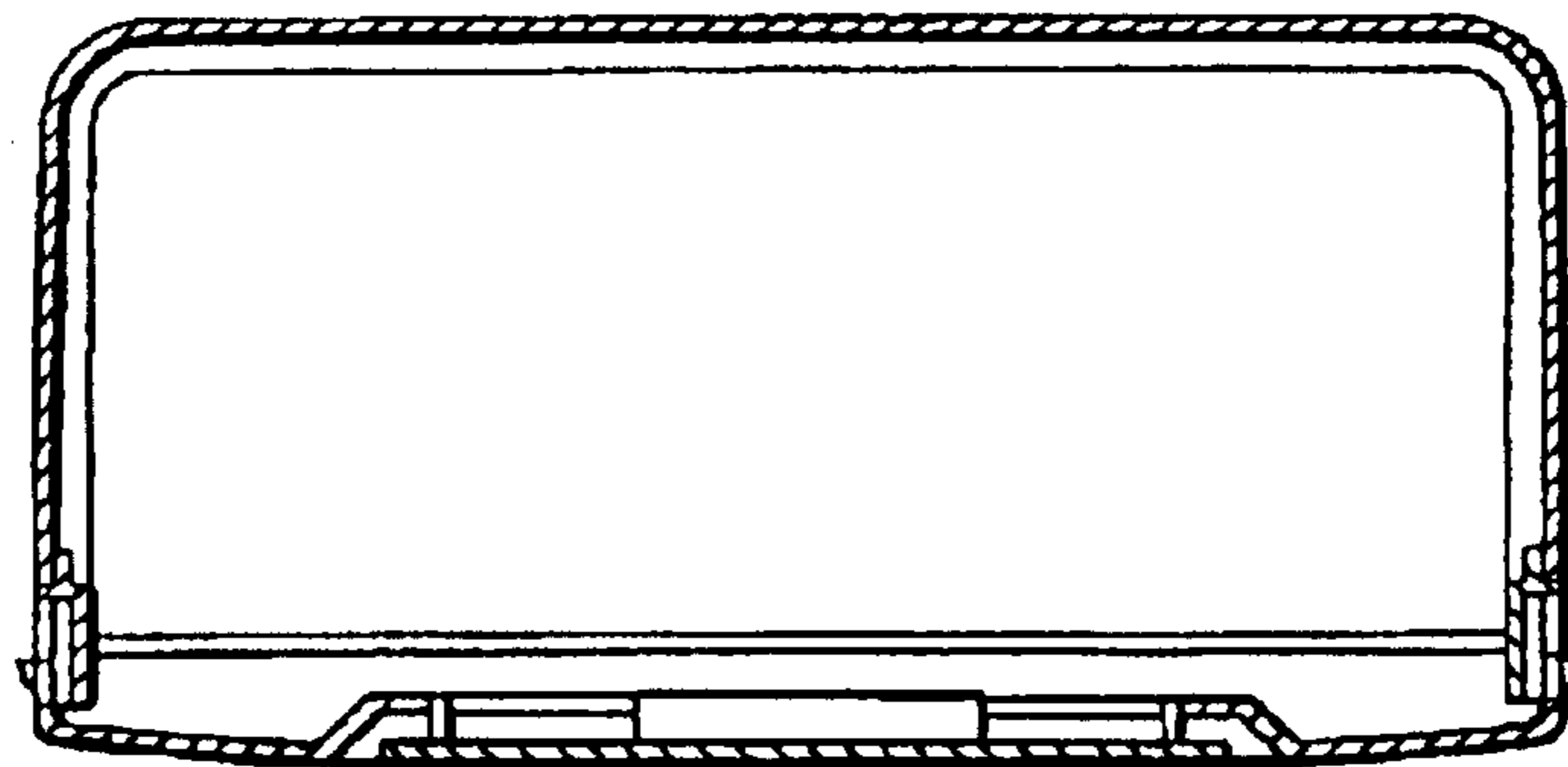

FIG. 8

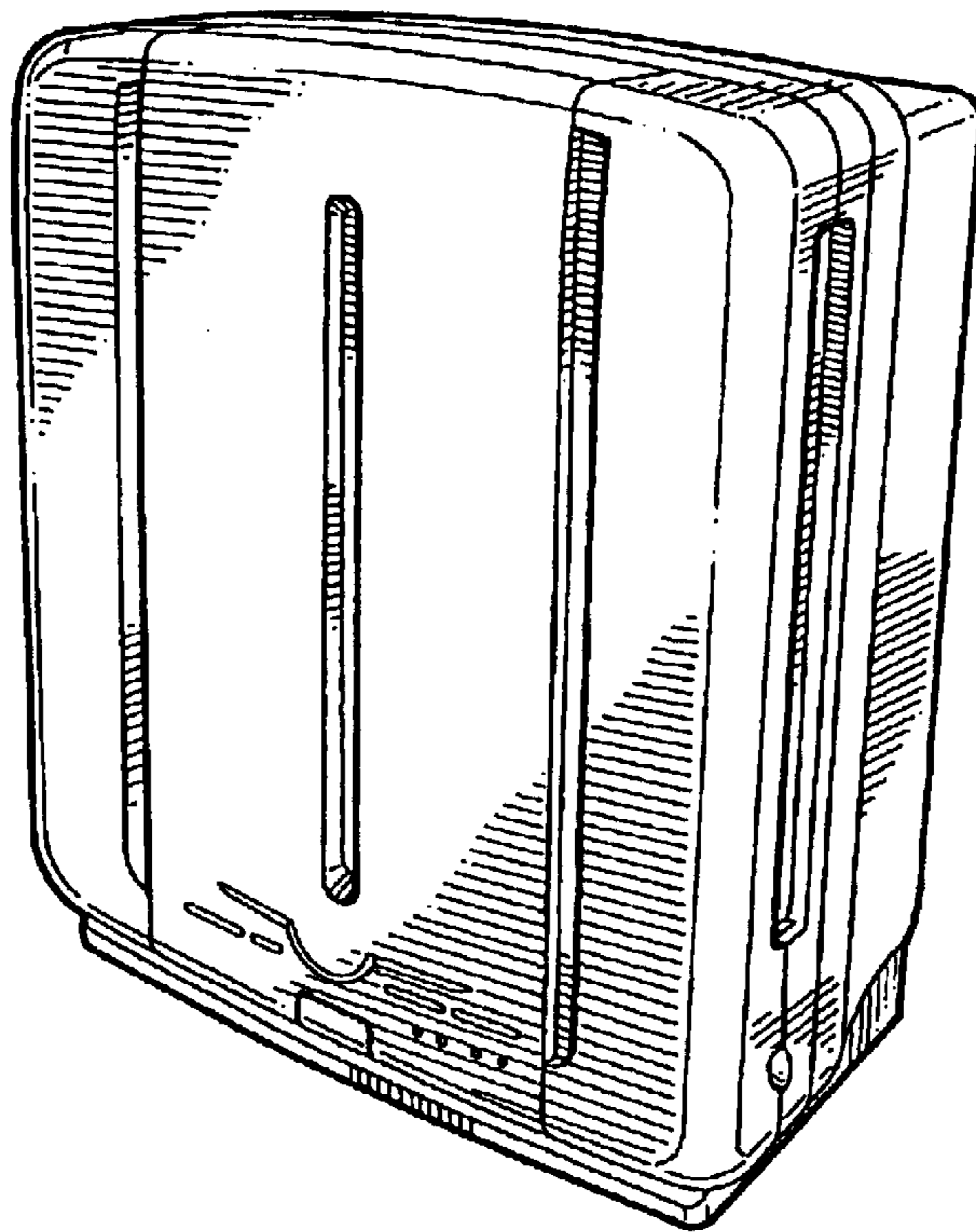

FIG. 9

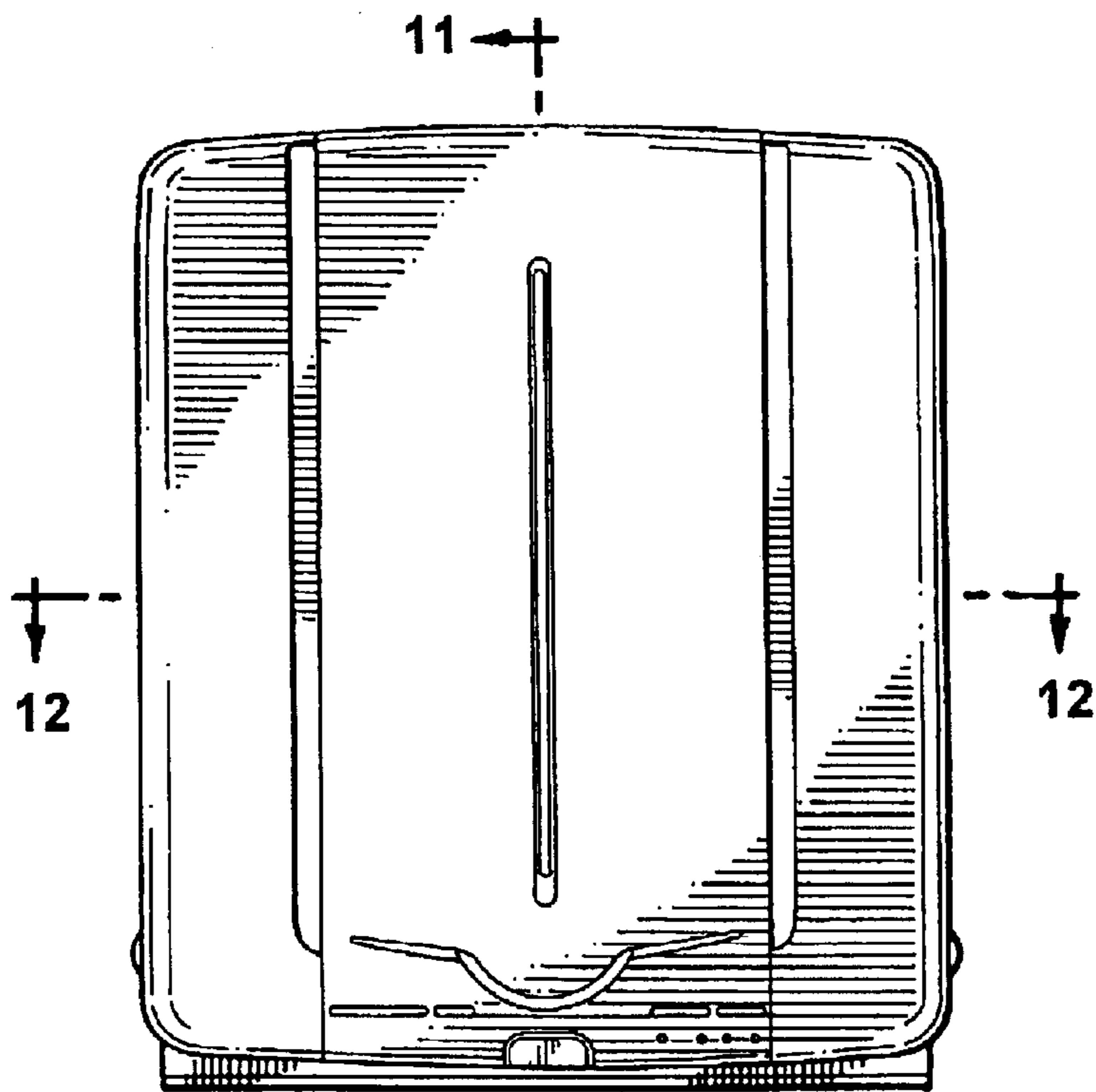

FIG. 10

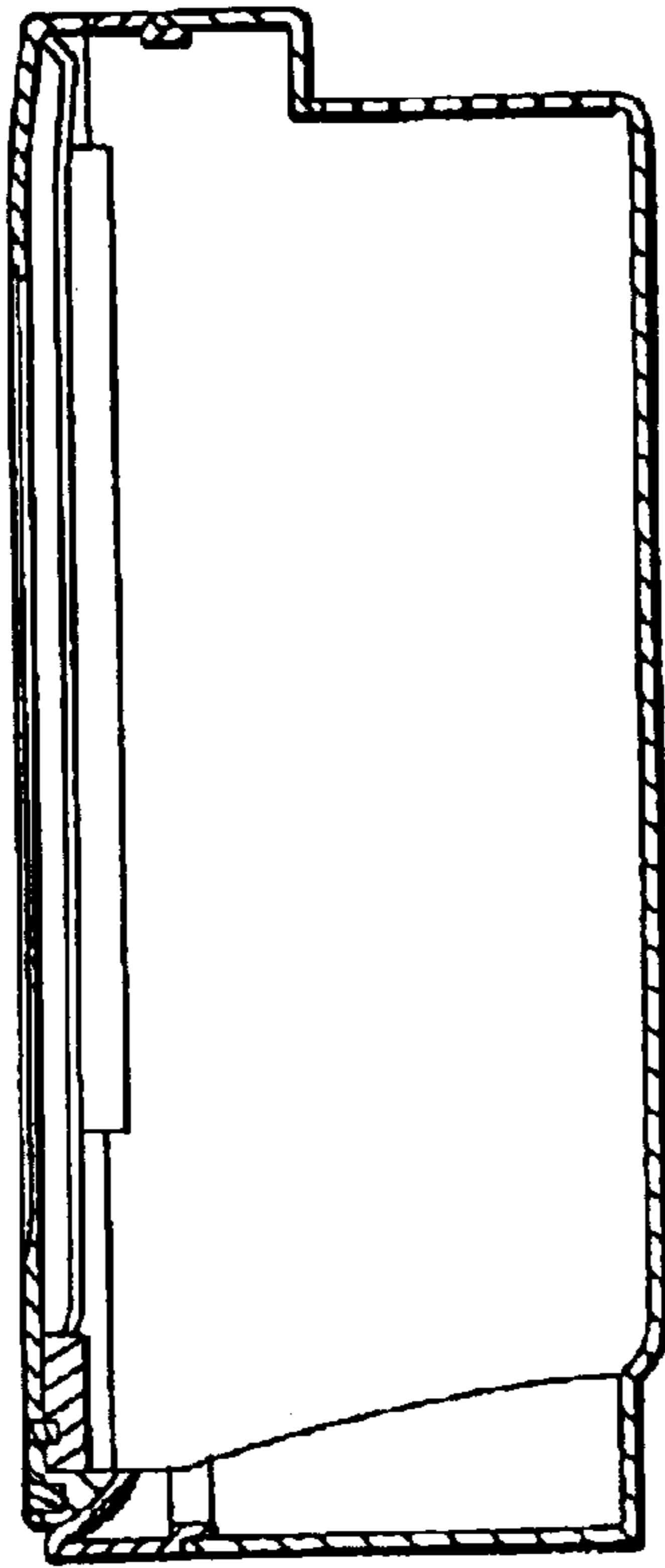

FIG. 11

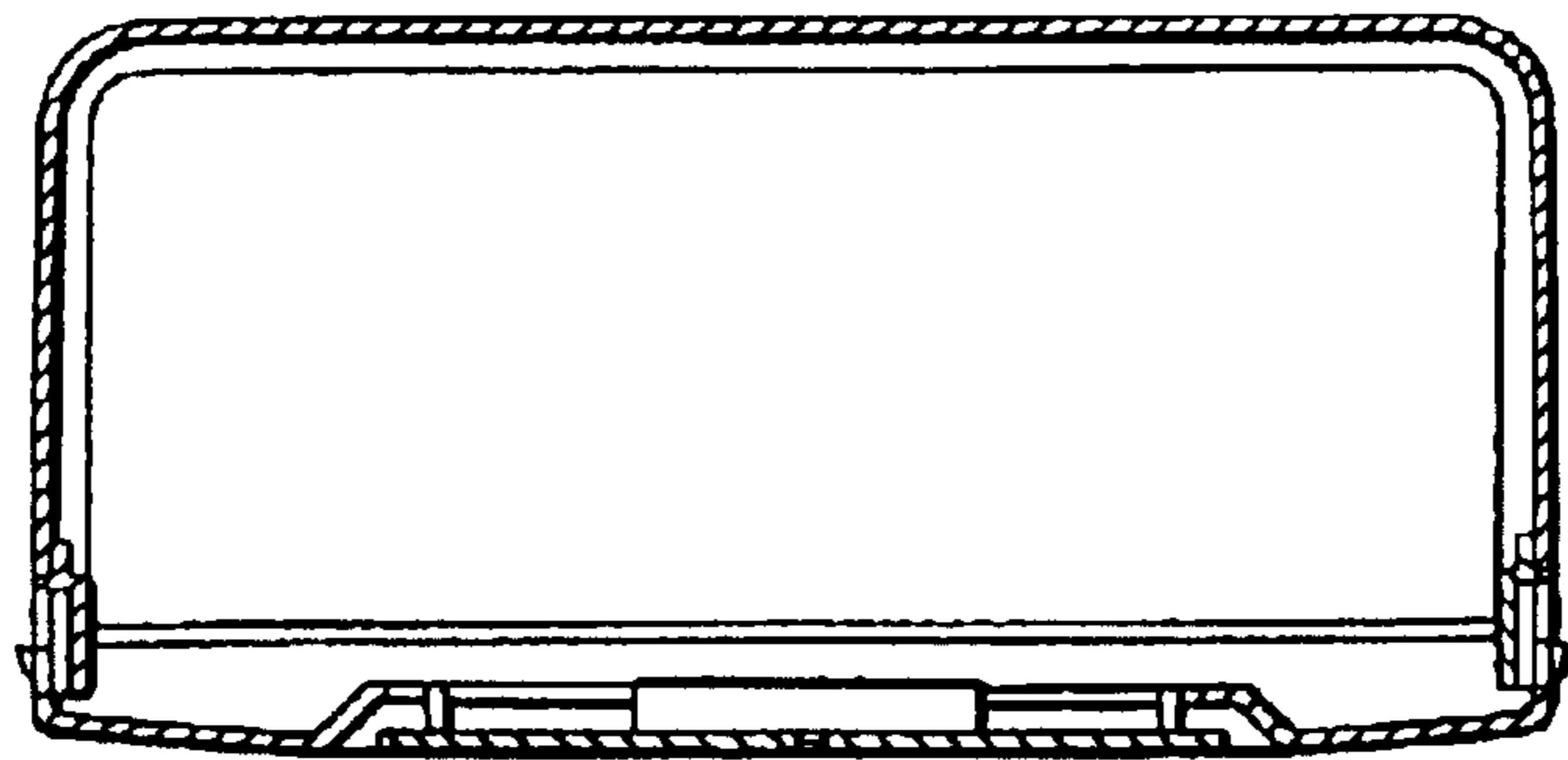

FIG. 12