



US00D489782S

(12) **United States Design Patent**
Burrows

(10) **Patent No.:** **US D489,782 S**

(45) **Date of Patent:** **** May 11, 2004**

(54) **IRON TYPE HEAD FOR A GOLF CLUB**

(57) **CLAIM**

(75) Inventor: **Bruce D. Burrows**, Santa Clarita, CA (US)

The ornamental design for a iron type head for a golf club, substantially as shown.

(73) Assignee: **Burrows Golf, Inc.**, Valencia, CA (US)

DESCRIPTION

(**) Term: **14 Years**

FIG. 1 is a perspective view showing the rear, top and toe end of an iron type head for a golf club embodying the new design;

(21) Appl. No.: **29/181,880**

FIG. 2 is a rear elevational view thereof;

(22) Filed: **May 15, 2003**

FIG. 3 is a front elevational view thereof;

(51) **LOC (7) Cl.** **21-02**

FIG. 4 is a top plan view thereof;

(52) **U.S. Cl.** **D21/747**

FIG. 5 is a bottom plan view thereof;

(58) **Field of Search** D21/747-751;
473/324-331, 350

FIG. 6 is a toe end elevational view thereof;

FIG. 7 is a heel end elevational view thereof;

(56) **References Cited**

FIG. 8 is a sectional view taken generally on the line 8—8 of FIG. 2;

U.S. PATENT DOCUMENTS

D268,856 S	*	5/1983	Fisher	D21/749
D279,022 S	*	5/1985	Worster et al.	D21/749
D314,803 S	*	2/1991	Antonious	D21/749
D387,113 S		12/1997	Burrows		
D392,356 S		3/1998	Burrows		
D401,652 S		11/1998	Burrows		
D406,294 S		3/1999	Burrows		
D411,272 S		6/1999	Burrows		
D418,887 S	*	1/2000	Williams, Jr.	D21/749

FIG. 9 is a perspective view showing the rear, top and toe end sides of an alternative form of the new design, the front, right and left side elevational views and the top plan view being identical to the embodiment of FIGS. 1-8;

FIG. 10 is a rear elevational view the embodiment of FIG. 9; and,

FIG. 11 is a sectional view taken on the line 11—11 of FIG. 10.

* cited by examiner

The dotted line depiction of a faceplate groove pattern is for illustrative purposes only and forms no part of the claimed design.

Primary Examiner—Mitchell Siegel

(74) *Attorney, Agent, or Firm*—Kelly Bauersfeld Lowry & Kelley, LLP

1 Claim, 4 Drawing Sheets

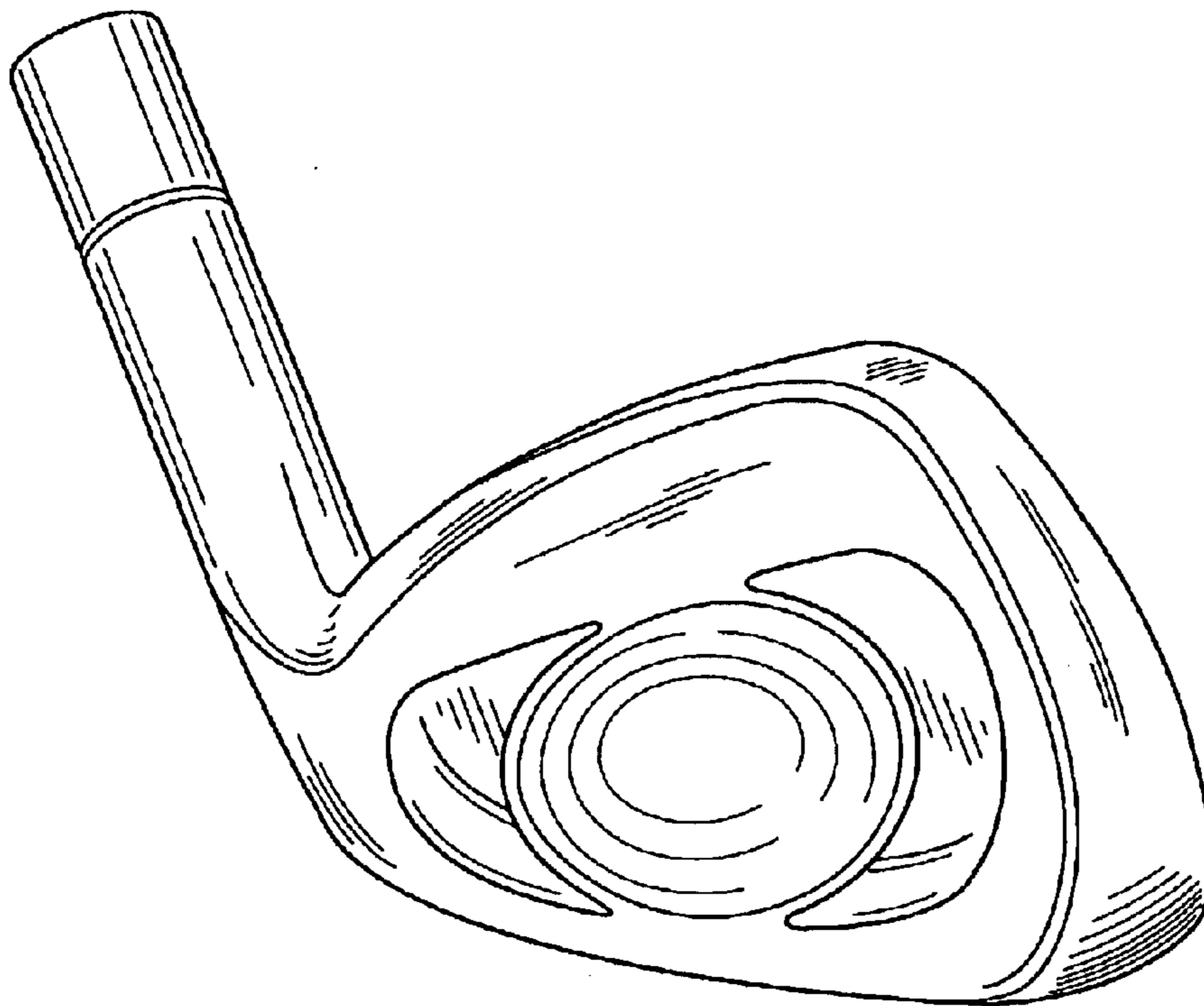

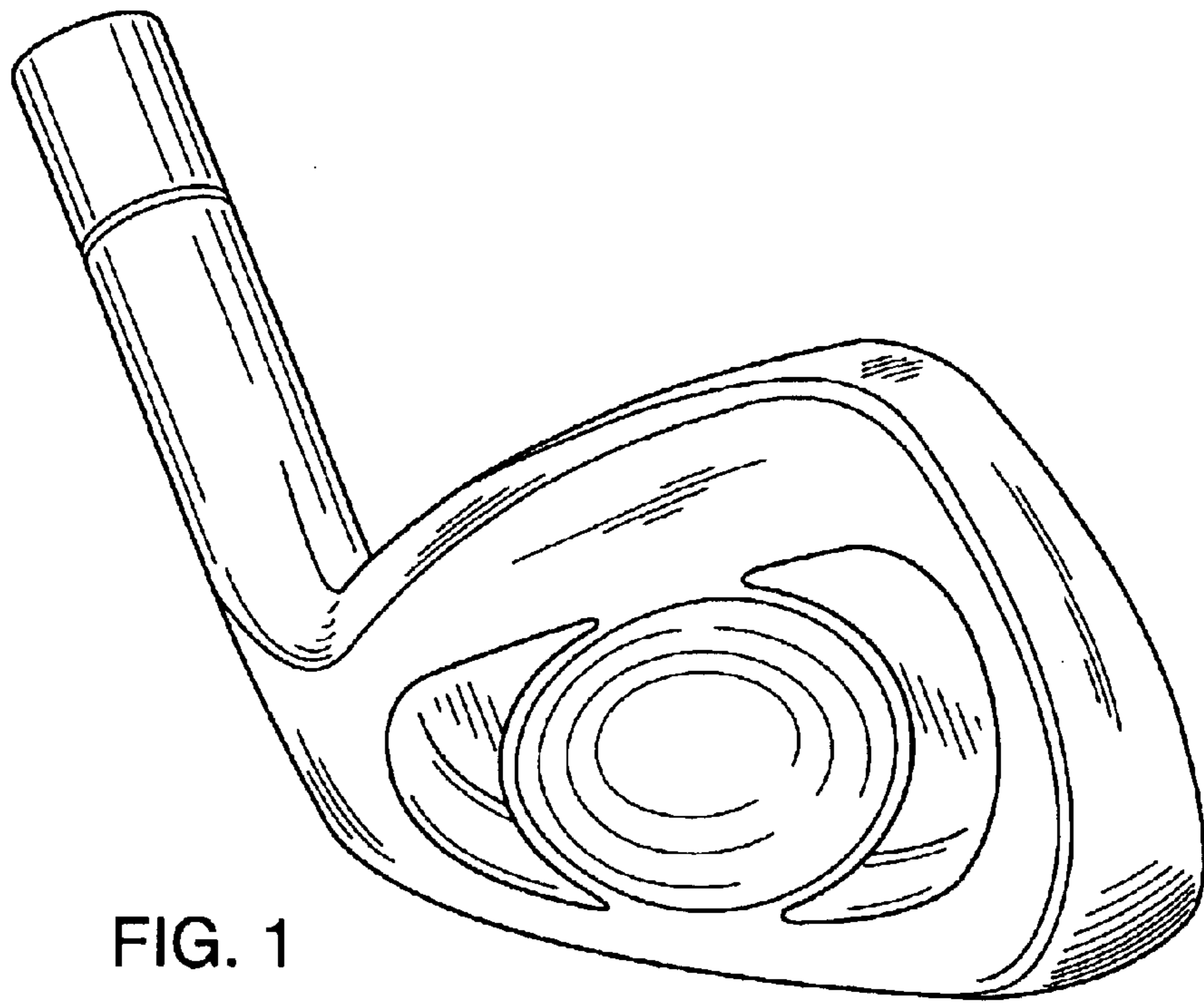

FIG. 1

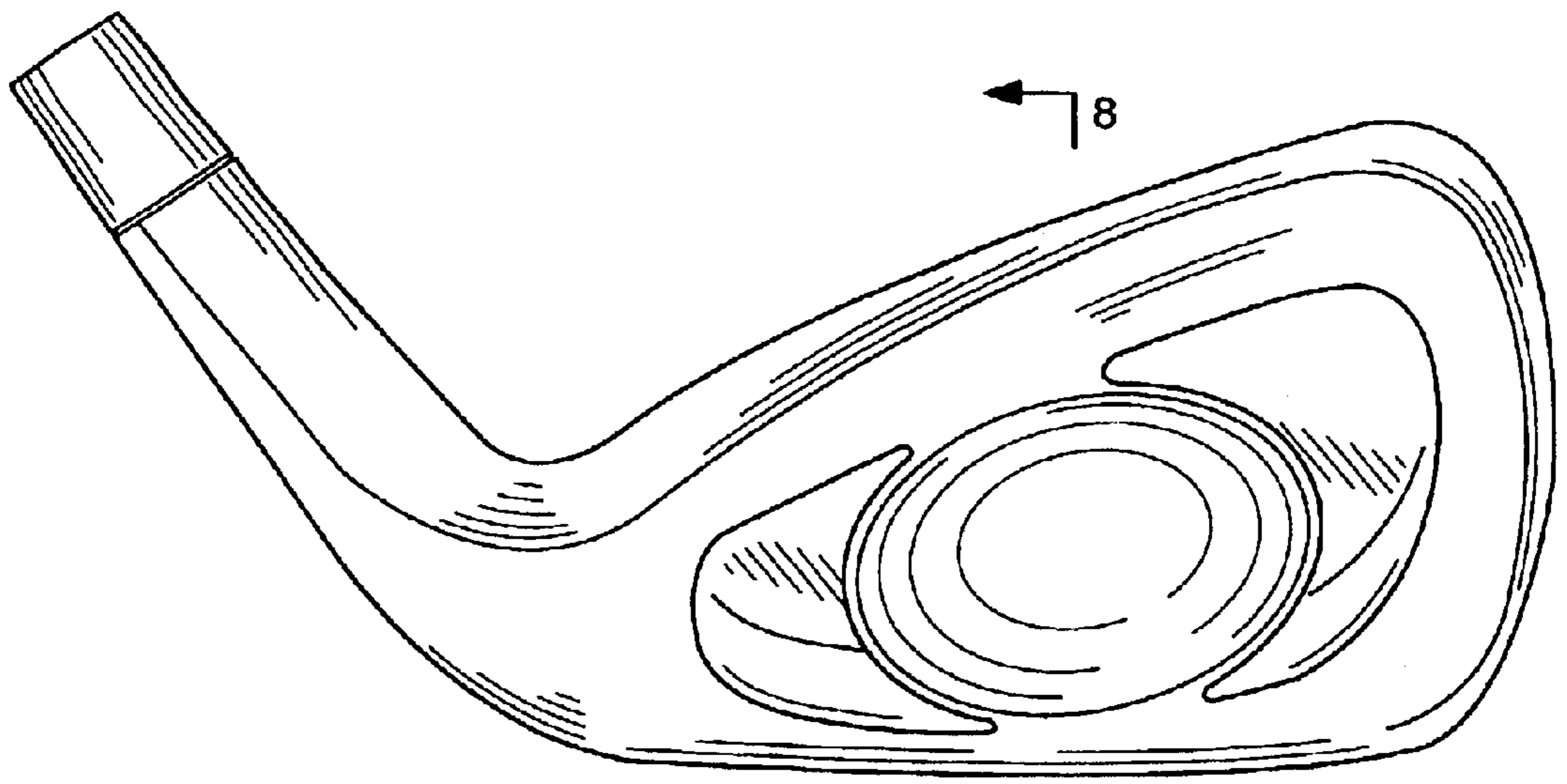

FIG. 2

FIG. 3

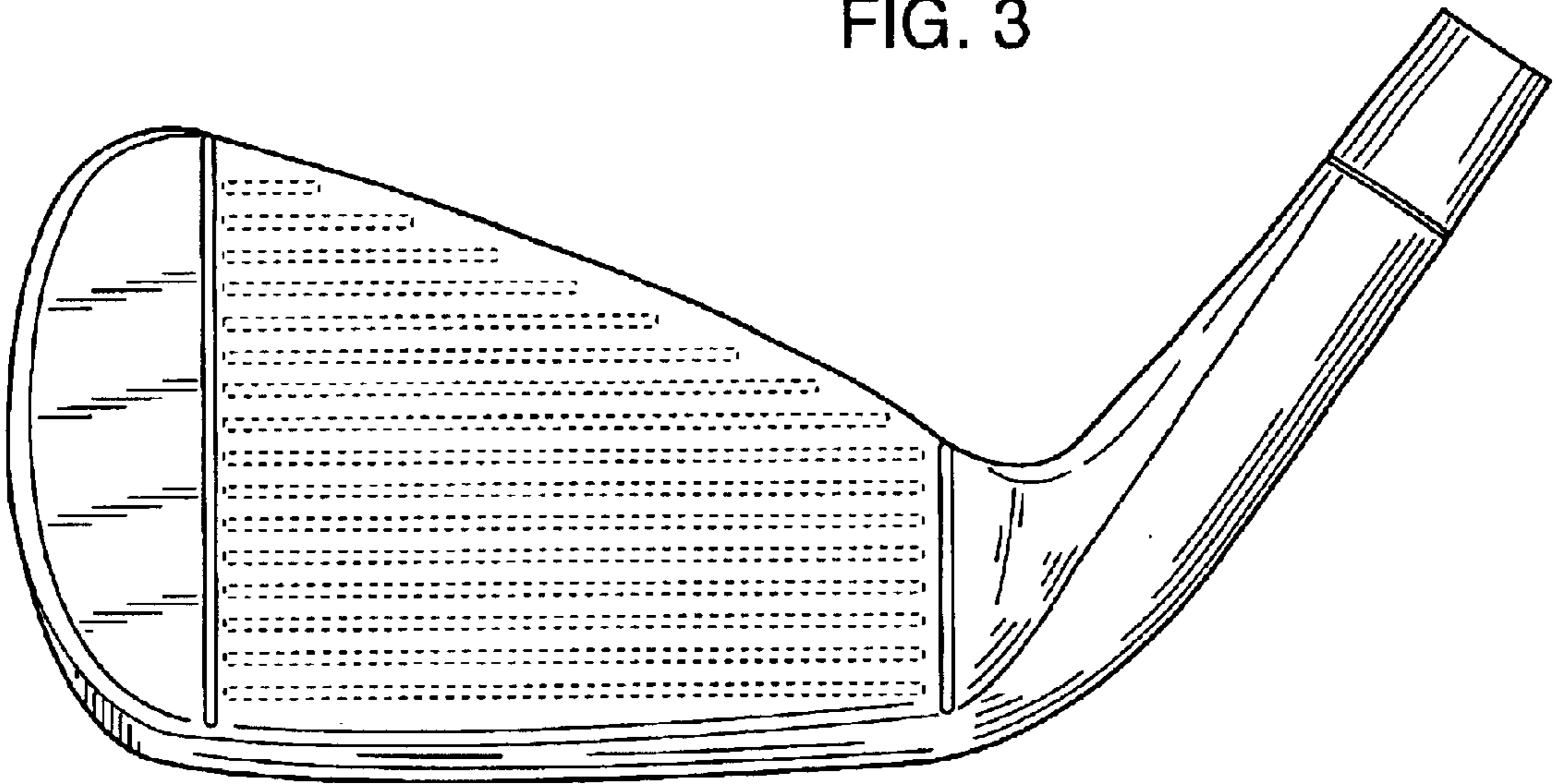

FIG. 4

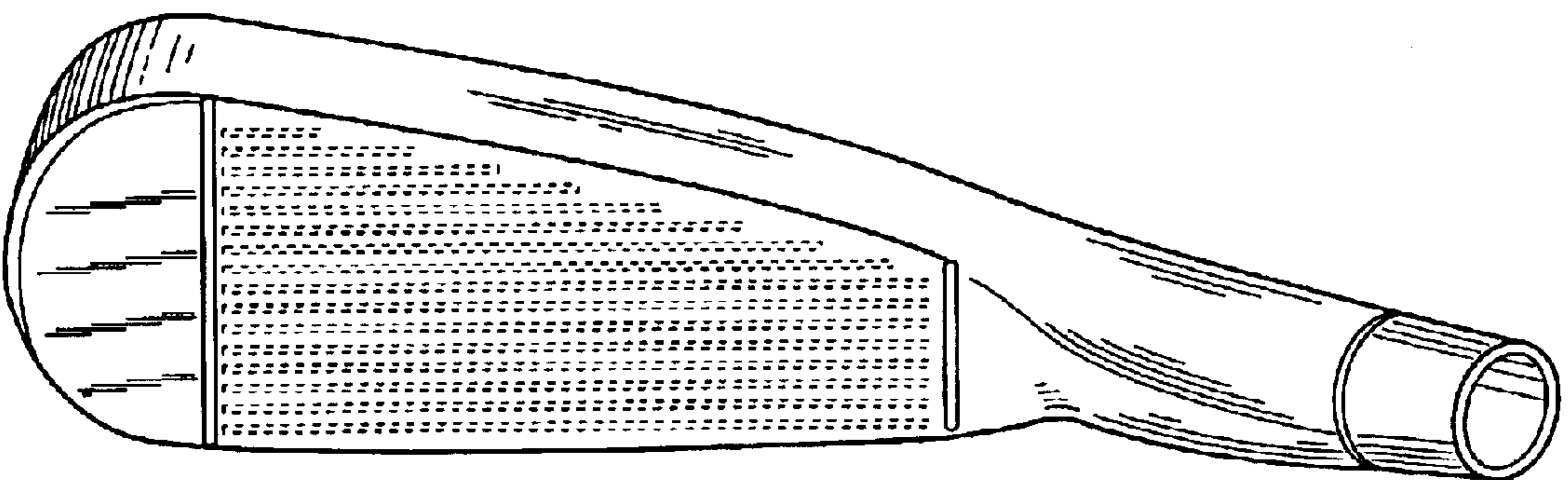

FIG. 5

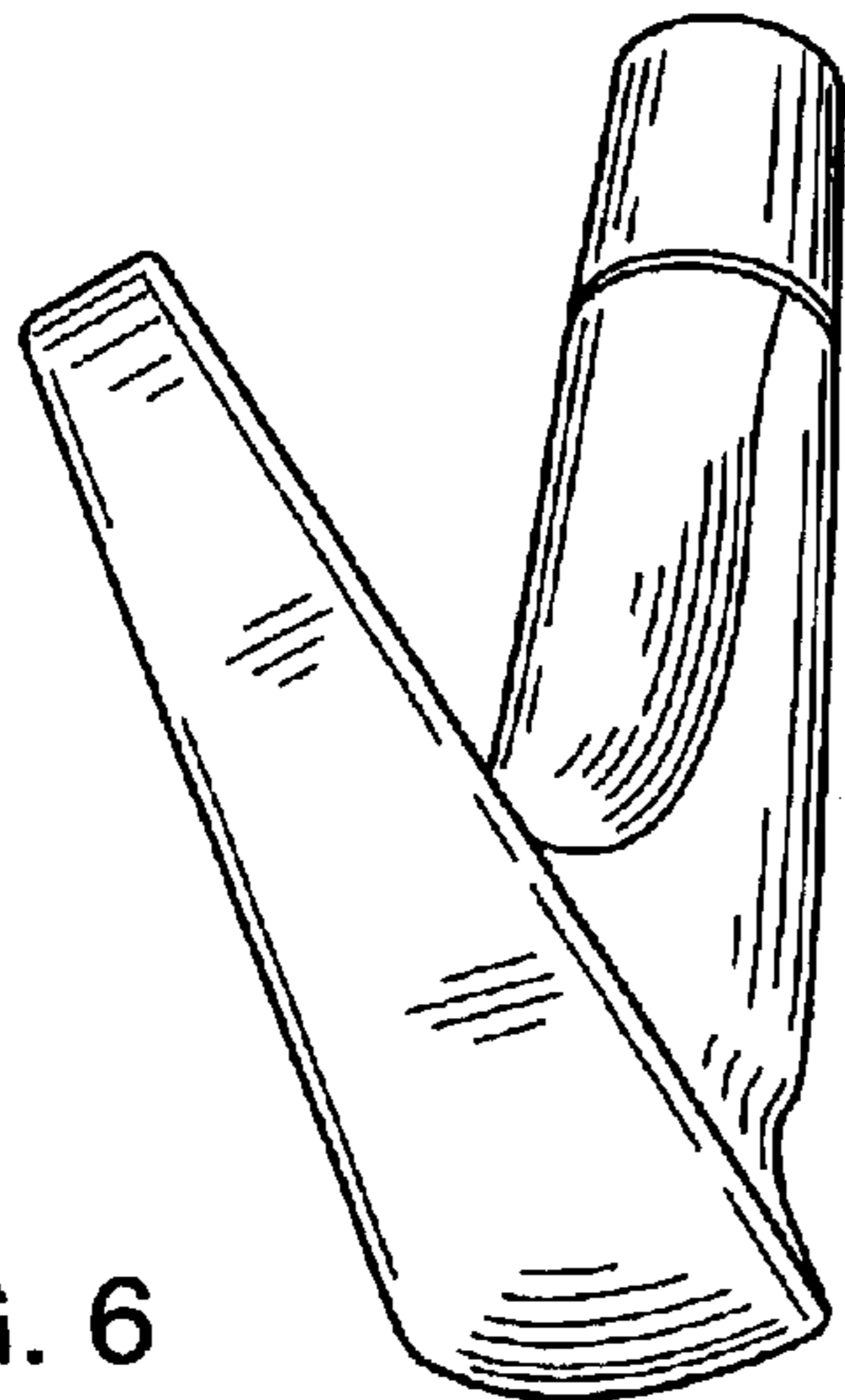
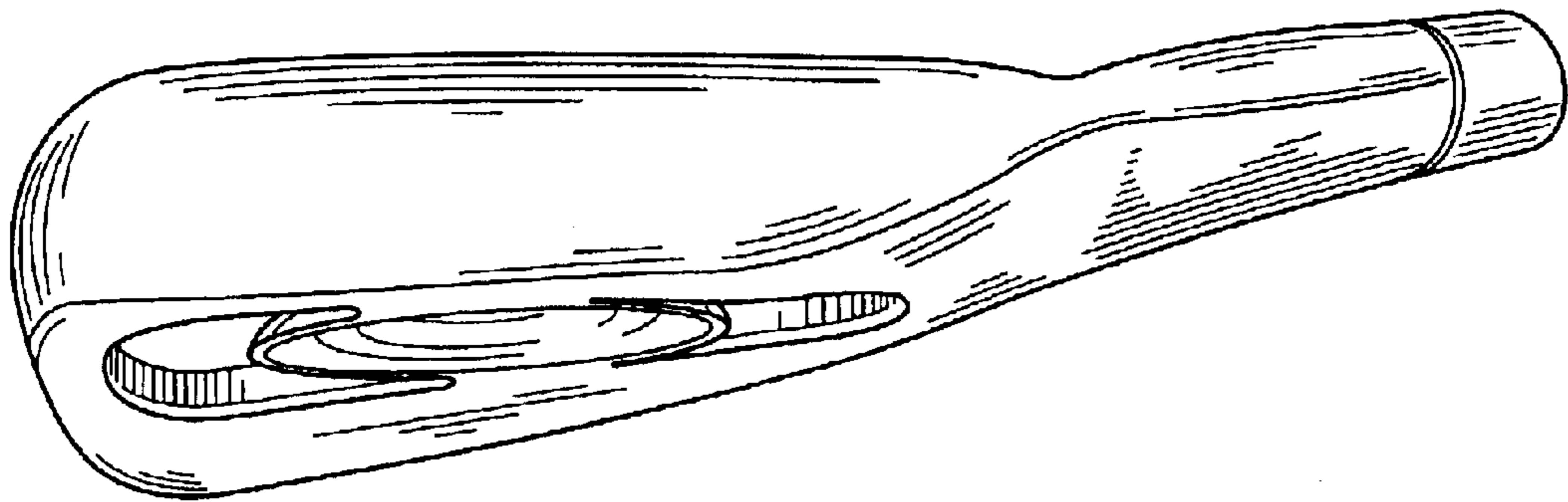

FIG. 6

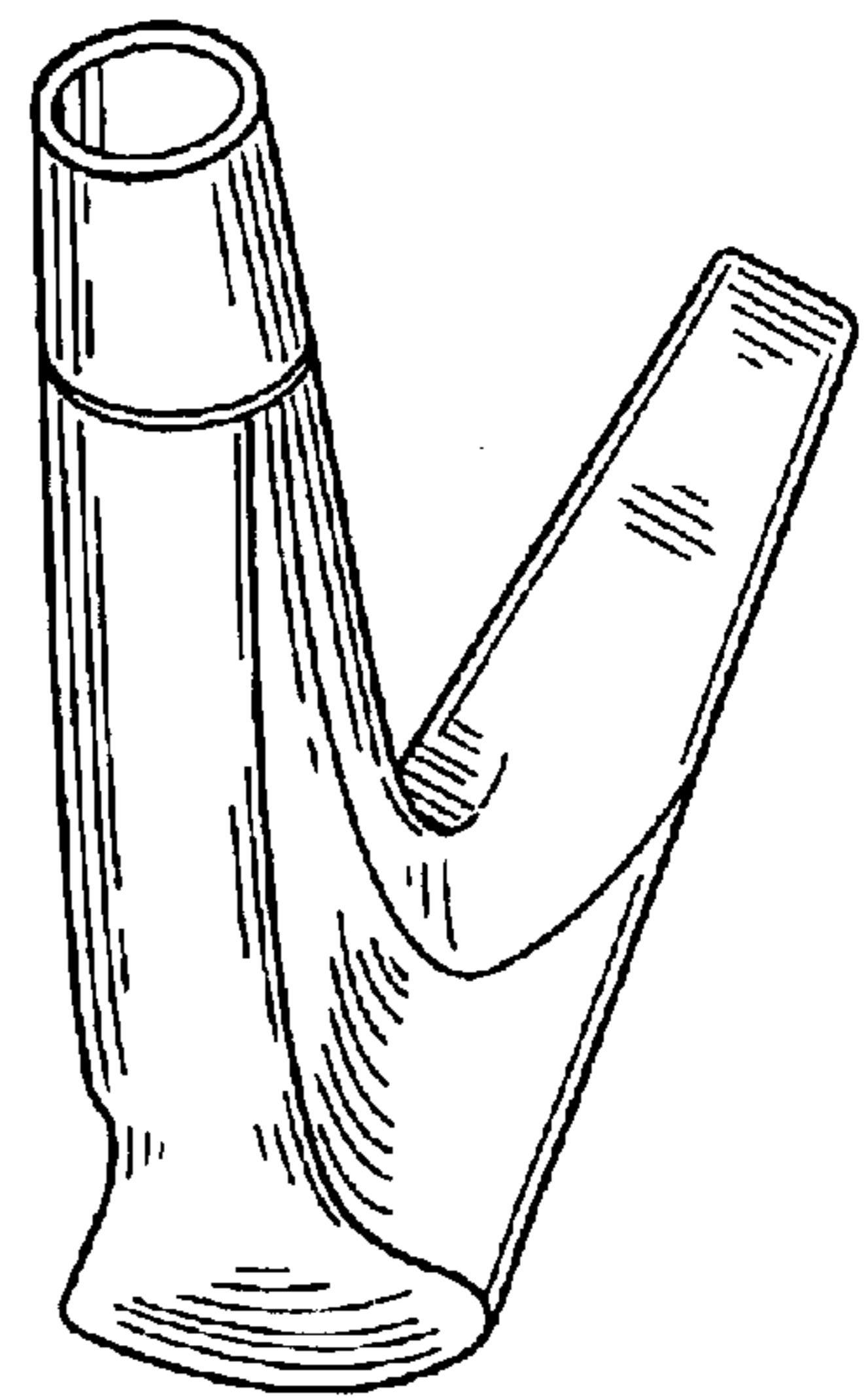

FIG. 7

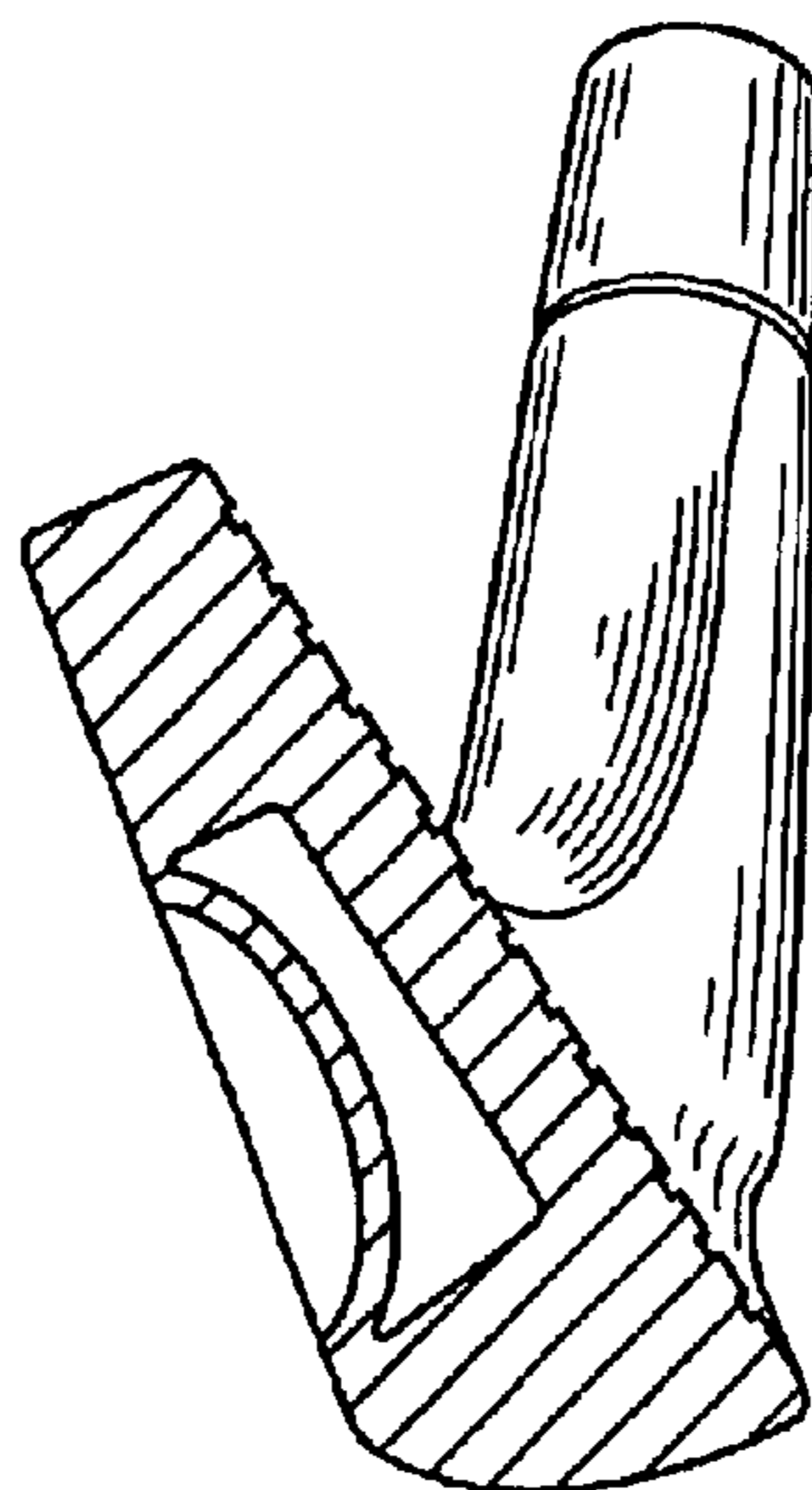

FIG. 8

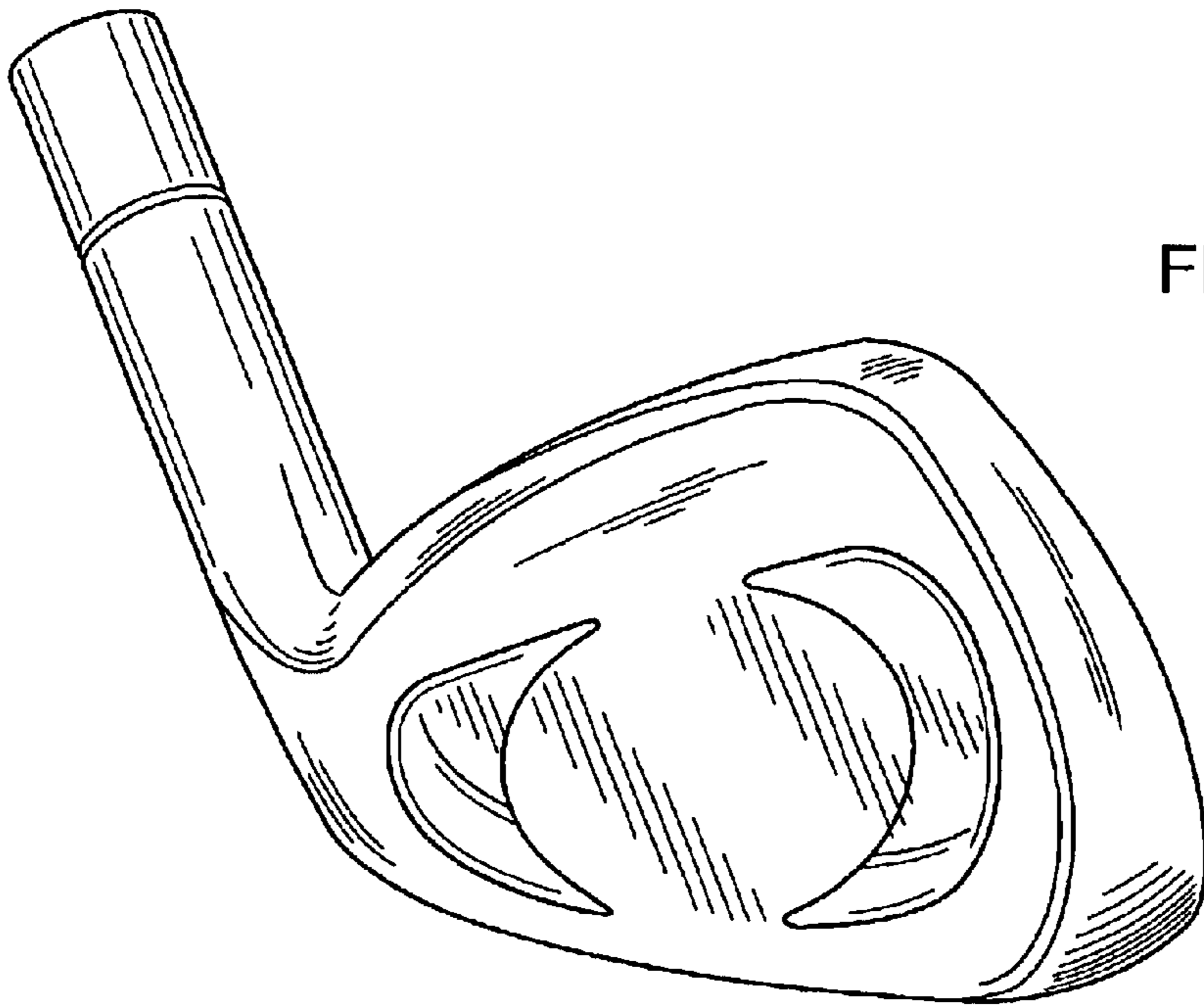

FIG. 9

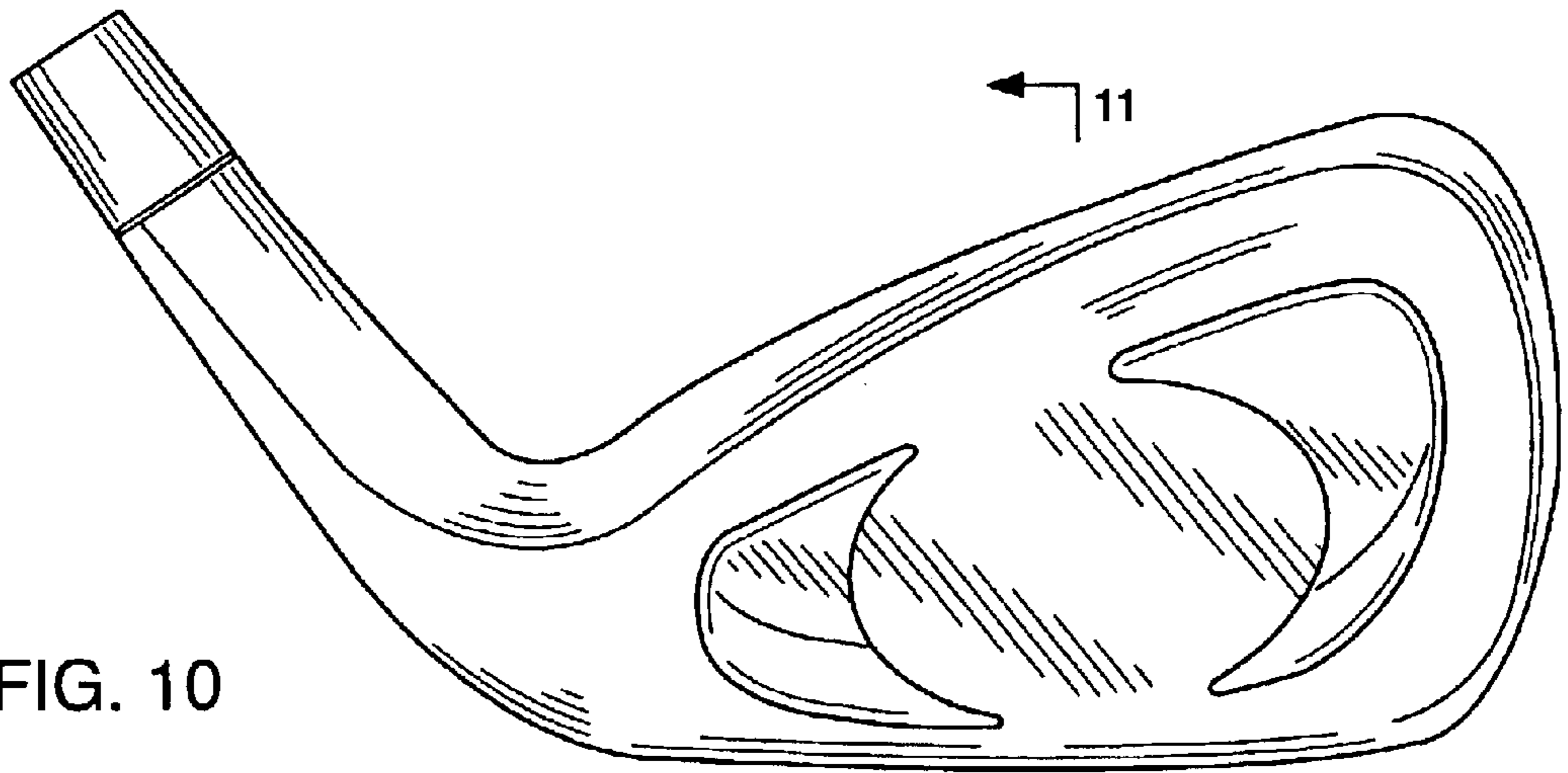

FIG. 10

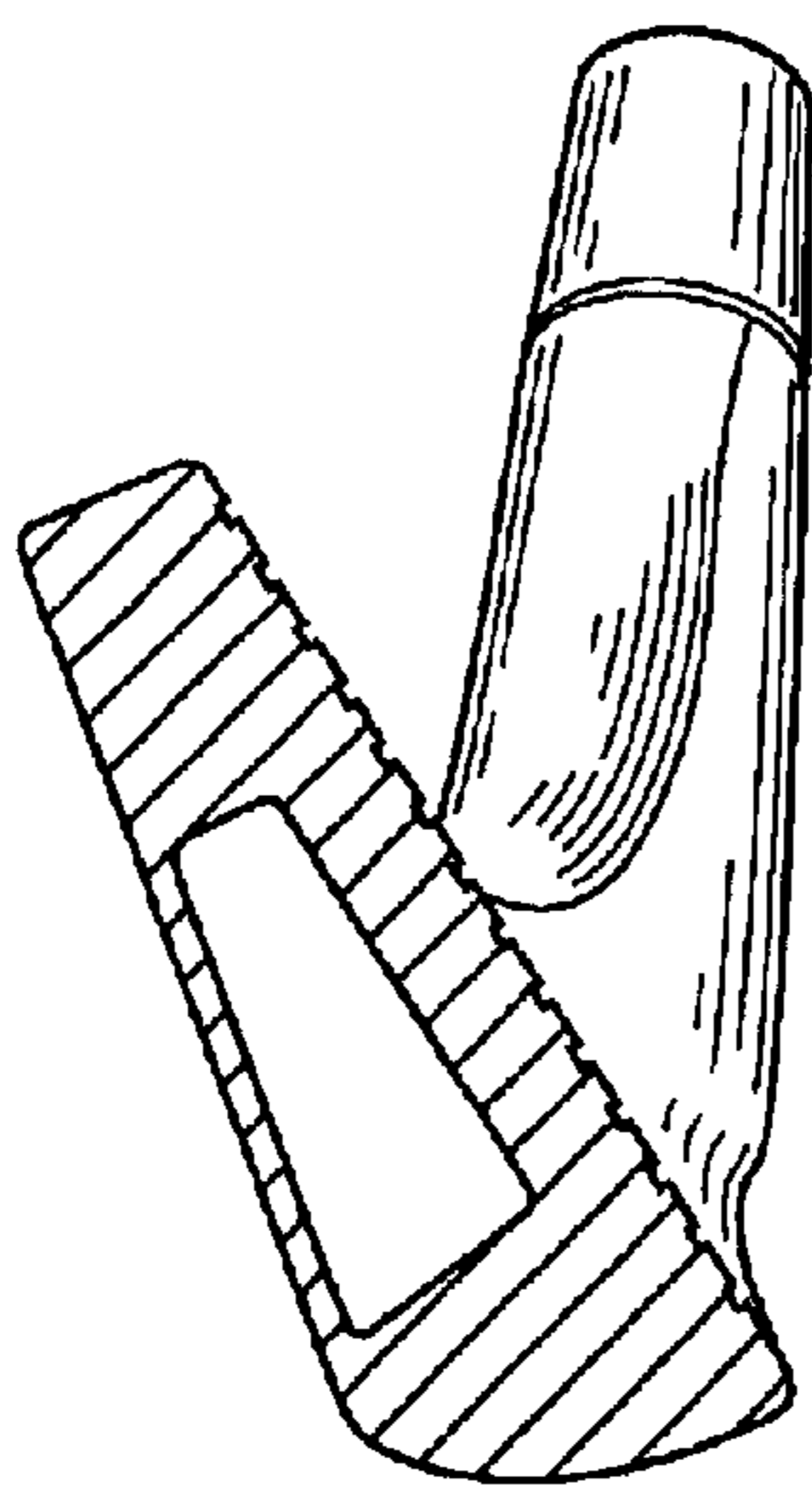

FIG. 11