



US00D489752S

(12) **United States Design Patent**
Yamaguchi et al.

(10) **Patent No.:** **US D489,752 S**

(45) **Date of Patent:** **** May 11, 2004**

(54) **IMAGE FORMING APPARATUS**

5,930,563 A * 7/1999 Reichl et al. 399/119
D478,615 S * 8/2003 Karakama et al. D18/40

(75) Inventors: **Koji Yamaguchi**, Numazu (JP);
Kazuhiko Kanno, Odawara (JP);
Tomio Noguchi, Sunto-gun (JP); **Yumi Fujiwara**, Sunto-gun (JP)

* cited by examiner

(73) Assignee: **Canon Kabushiki Kaisha**, Tokyo (JP)

Primary Examiner—Caron D. Veynar
(74) *Attorney, Agent, or Firm*—Fitzpatrick, Cella, Harper & Scinto

(**) Term: **14 Years**

(57) **CLAIM**

(21) Appl. No.: **29/171,910**

The ornamental design for an image forming apparatus, as shown and described.

(22) Filed: **Dec. 3, 2002**

(30) **Foreign Application Priority Data**

Jun. 5, 2002 (JP) 2002-015057

DESCRIPTION

(51) **LOC (7) Cl.** **16-03**

FIG. 1 is a front view of an image forming apparatus showing our new design;

(52) **U.S. Cl.** **D18/40**

FIG. 2 is a rear view thereof;

(58) **Field of Search** D18/12, 40, 43,
D18/56; 347/49, 86, 87, 101, 214; 399/106,
110, 111, 114, 119, 120, 259, 262

FIG. 3 is a top plan view thereof;

FIG. 4 is a bottom plan view thereof;

FIG. 5 is a left side view thereof;

FIG. 6 is a right side view thereof; and,

FIG. 7 is a perspective view thereof.

(56) **References Cited**

U.S. PATENT DOCUMENTS

D378,830 S * 4/1997 Kim D18/43

1 Claim, 7 Drawing Sheets

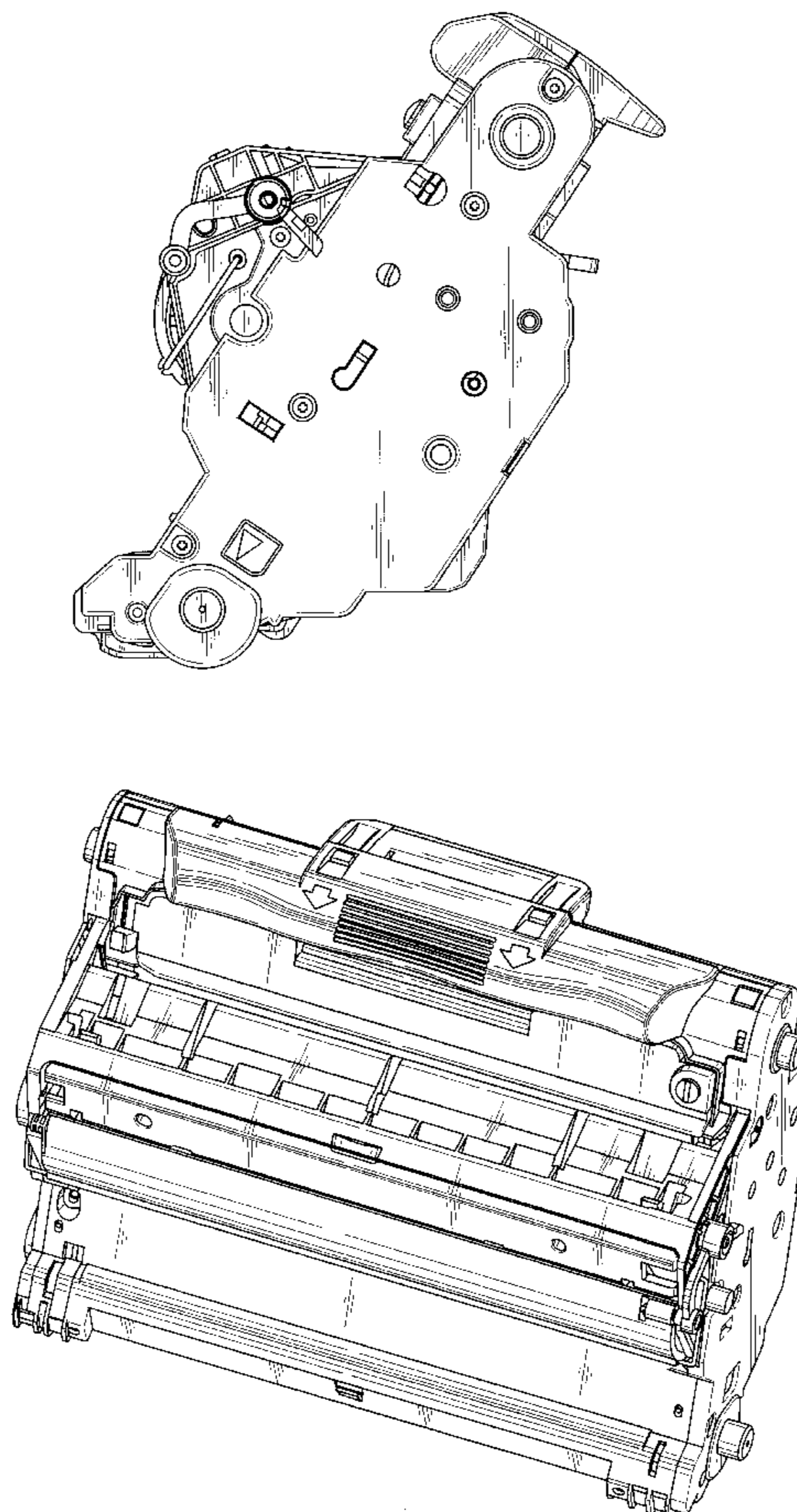

FIG. 1

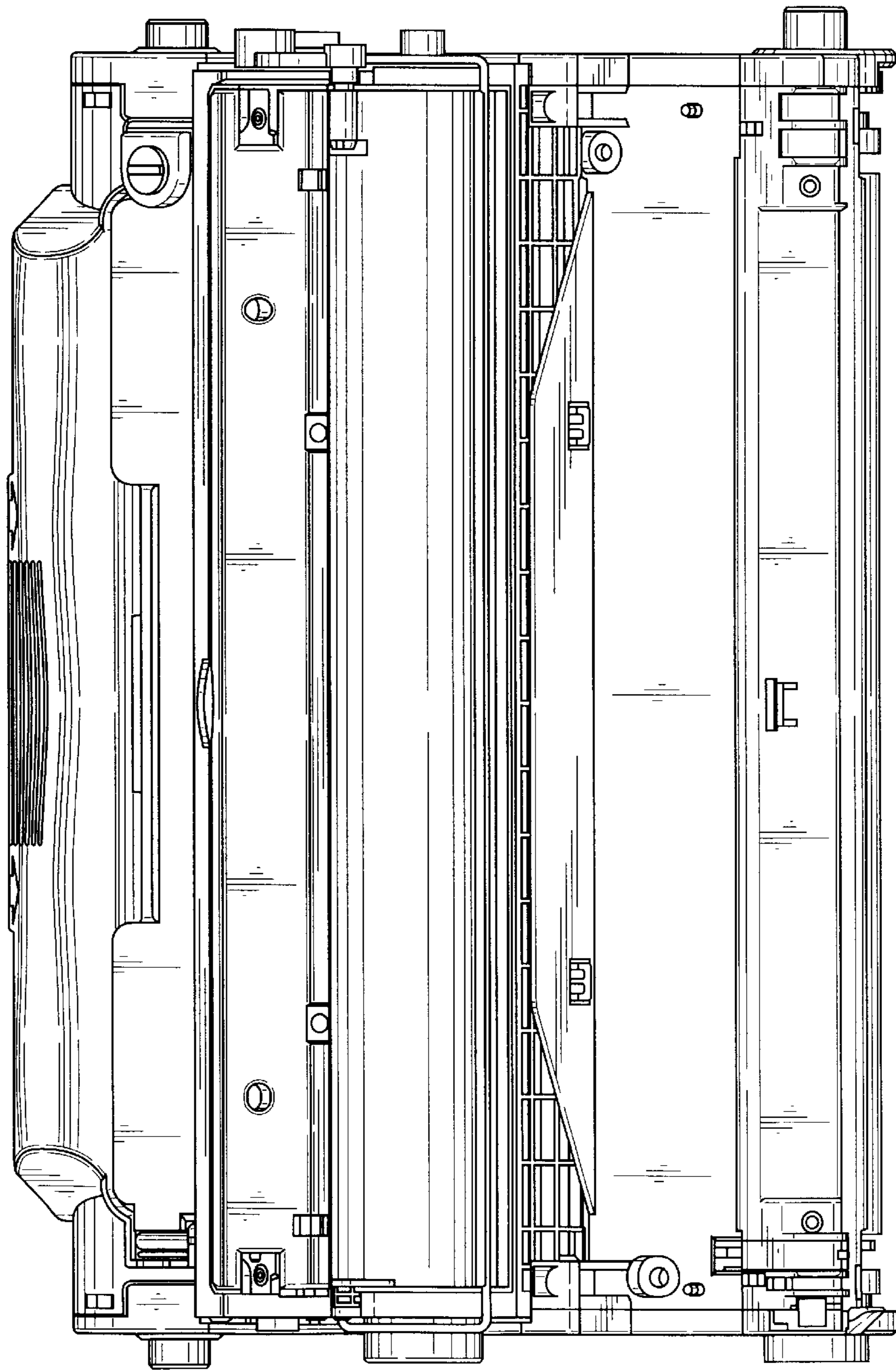

FIG. 2

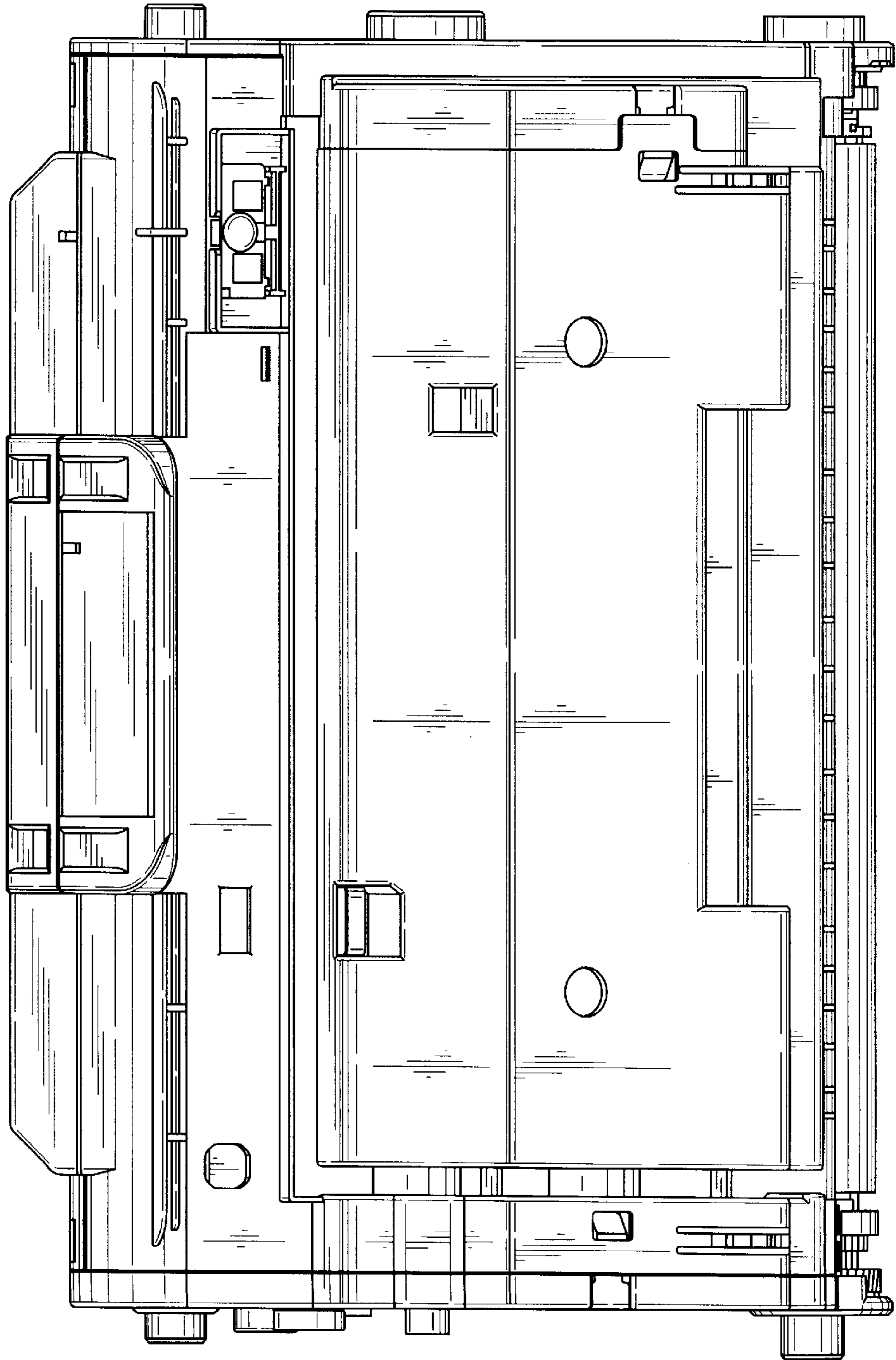

FIG. 3

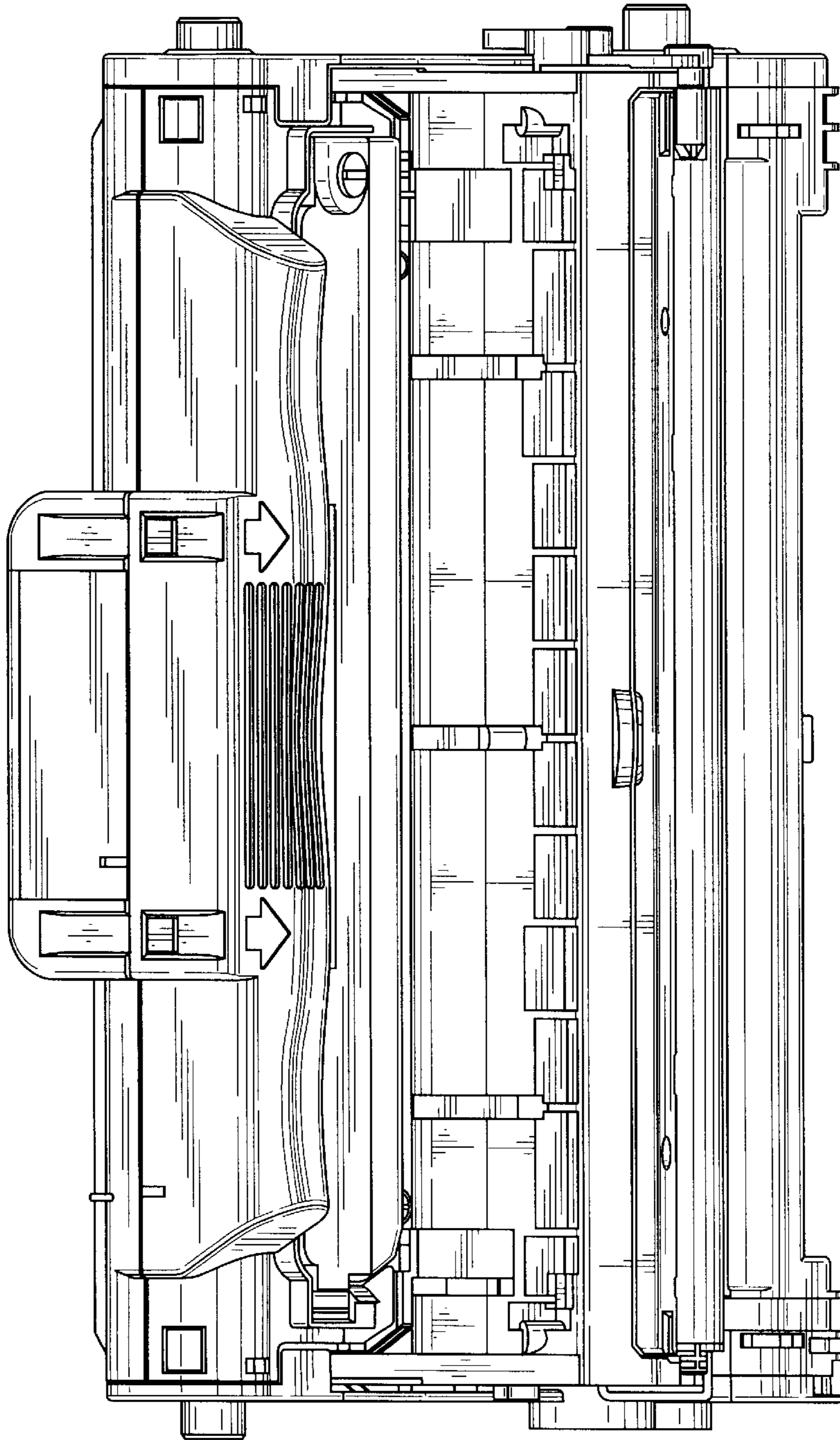

FIG. 4

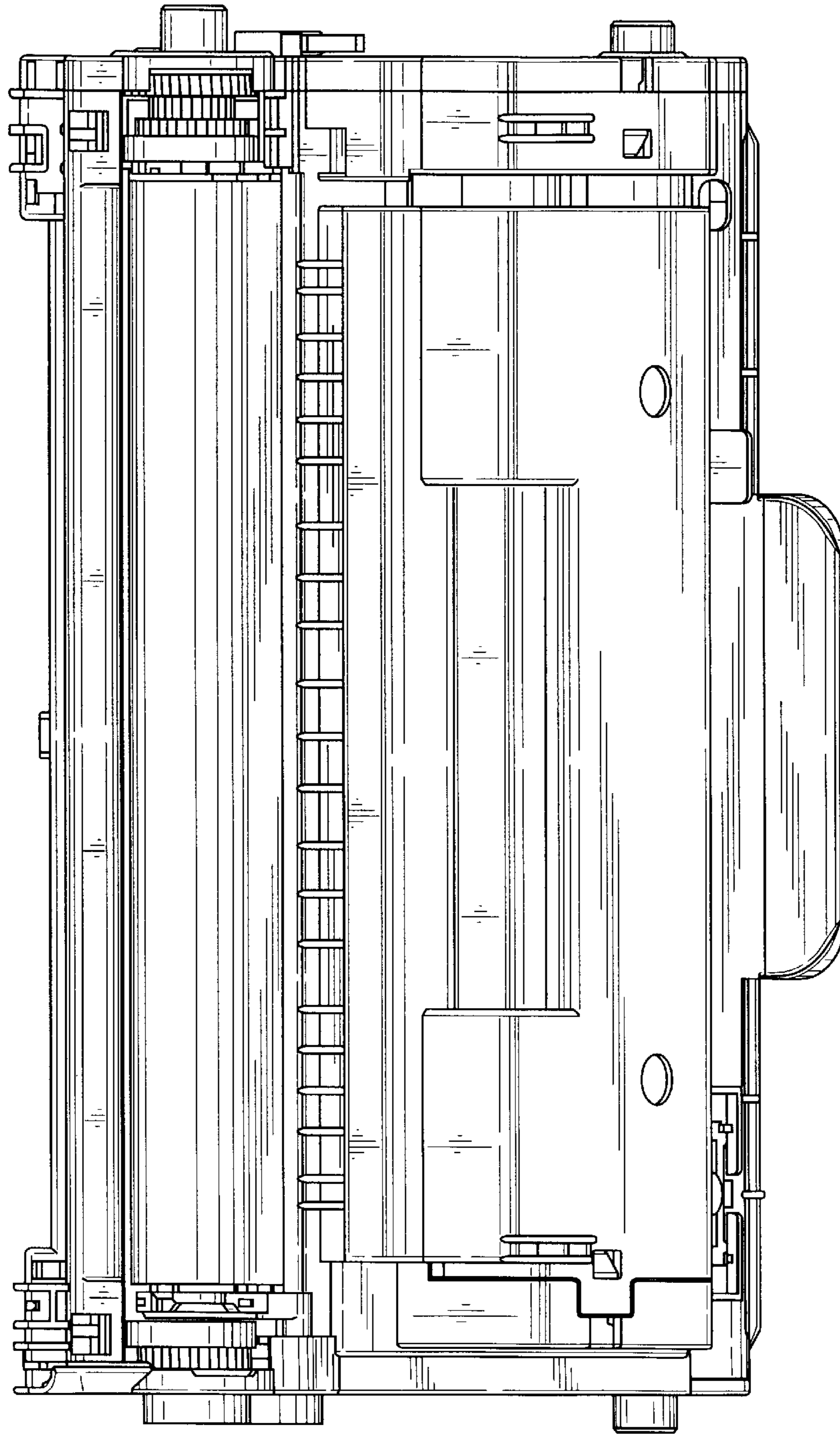

FIG. 5

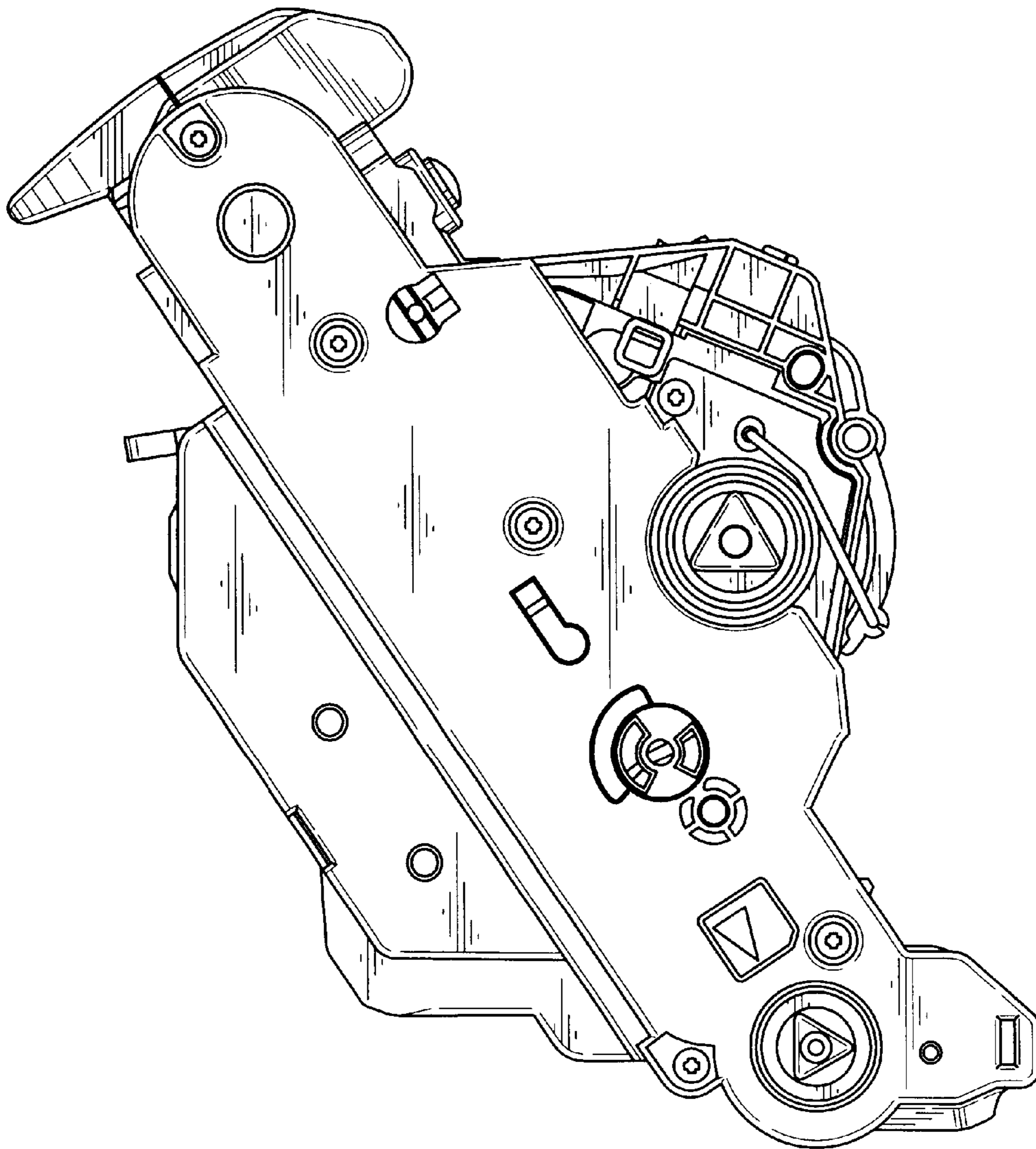

FIG. 6

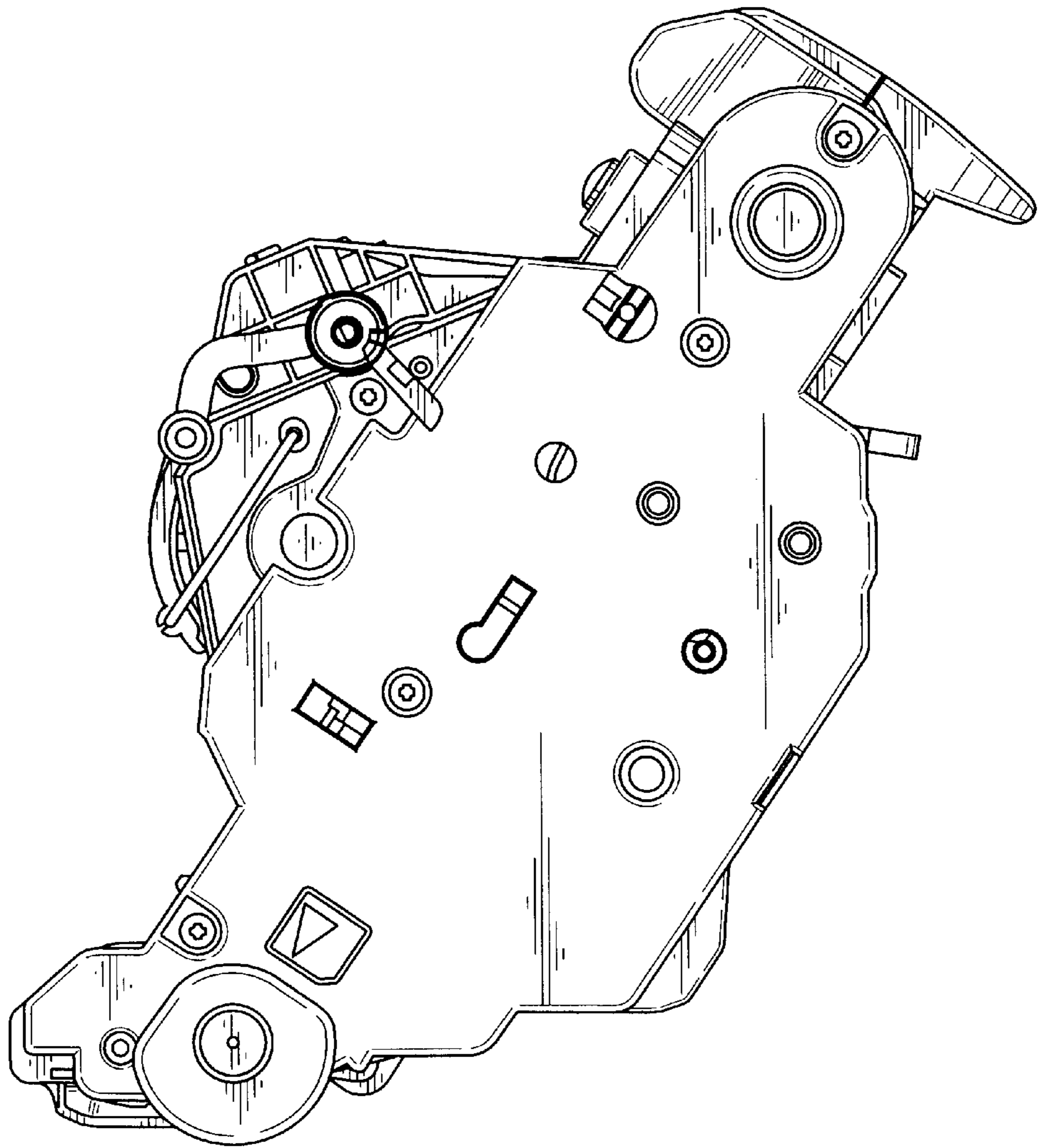

FIG. 7

