



US00D489729S

(12) **United States Design Patent**
Xu et al.

(10) **Patent No.:** **US D489,729 S**

(45) **Date of Patent:** **** May 11, 2004**

(54) **COMPUTER FRONT BEZEL**

D468,137 S * 1/2003 Chien et al. D14/444

(75) Inventors: **Yundong Xu**, Shenzhen (CN); **Perry Chih Wei**, Taipei (TW)

* cited by examiner

(73) Assignee: **Hon Hai Precision Ind. Co., Ltd.**, Taipei Hsien (TW)

Primary Examiner—Freda Nunn
(74) *Attorney, Agent, or Firm*—Wei Te Chung

(**) Term: **14 Years**

(57) **CLAIM**

The ornamental design for a computer front bezel, as shown and described.

(21) Appl. No.: **29/181,199**

(22) Filed: **May 5, 2003**

DESCRIPTION

(51) **LOC (7) Cl.** **14-02**

(52) **U.S. Cl.** **D14/444**

(58) **Field of Search** D14/441-446;
D13/162, 184, 199; 312/223.2; 361/690-696

FIG. 1 is a perspective view of a computer front bezel of our new design;
FIG. 2 is a front elevational view thereof;
FIG. 3 is a rear elevational view thereof;
FIG. 4 is a left side elevational view thereof;
FIG. 5 is a right side elevational view thereof;
FIG. 6 is a top plan view thereof;
FIG. 7 is a bottom plan view thereof; and,
FIG. 8 is a perspective view thereof being mounted to a computer case which is shown in broken lines for illustrative purposes only and forms no part of the claimed design.

(56) **References Cited**

U.S. PATENT DOCUMENTS

5,169,218	A	*	12/1992	Chu	312/223.2
6,000,769	A	*	12/1999	Chen	312/223.2
D425,078	S	*	5/2000	Jean et al.	D14/441
D431,825	S	*	10/2000	Jean et al.	D14/444
D439,254	S	*	3/2001	Zhao	D14/441

1 Claim, 6 Drawing Sheets

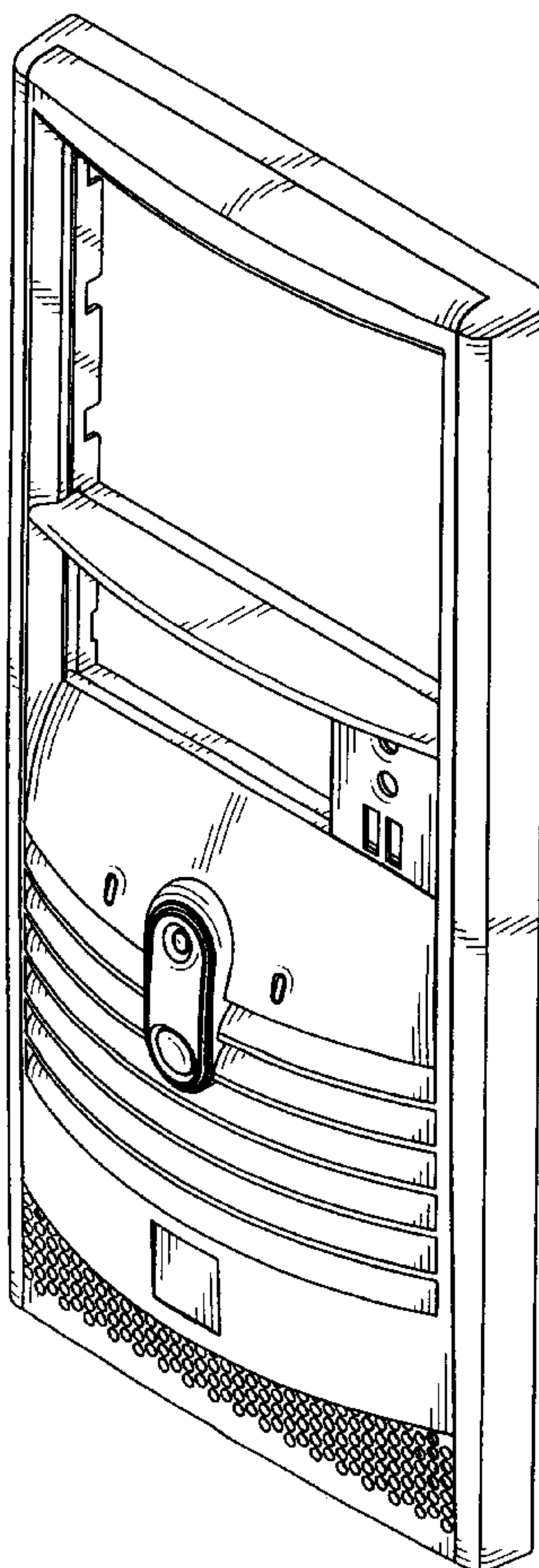

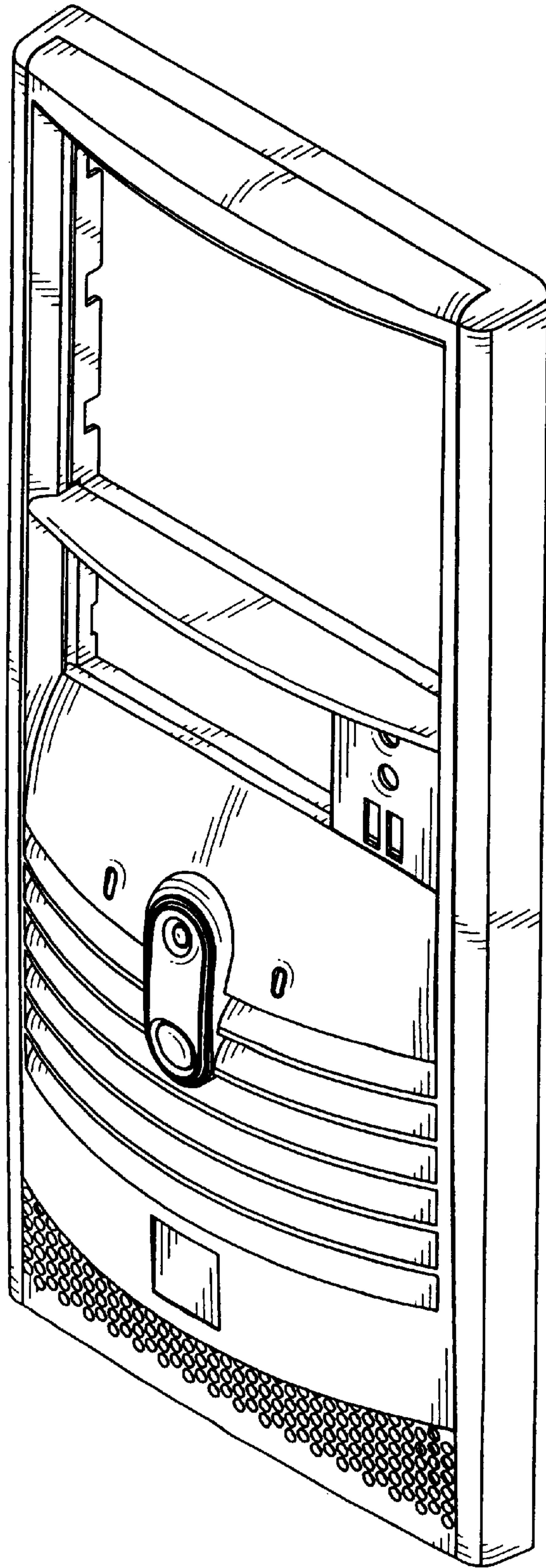

FIG. 1

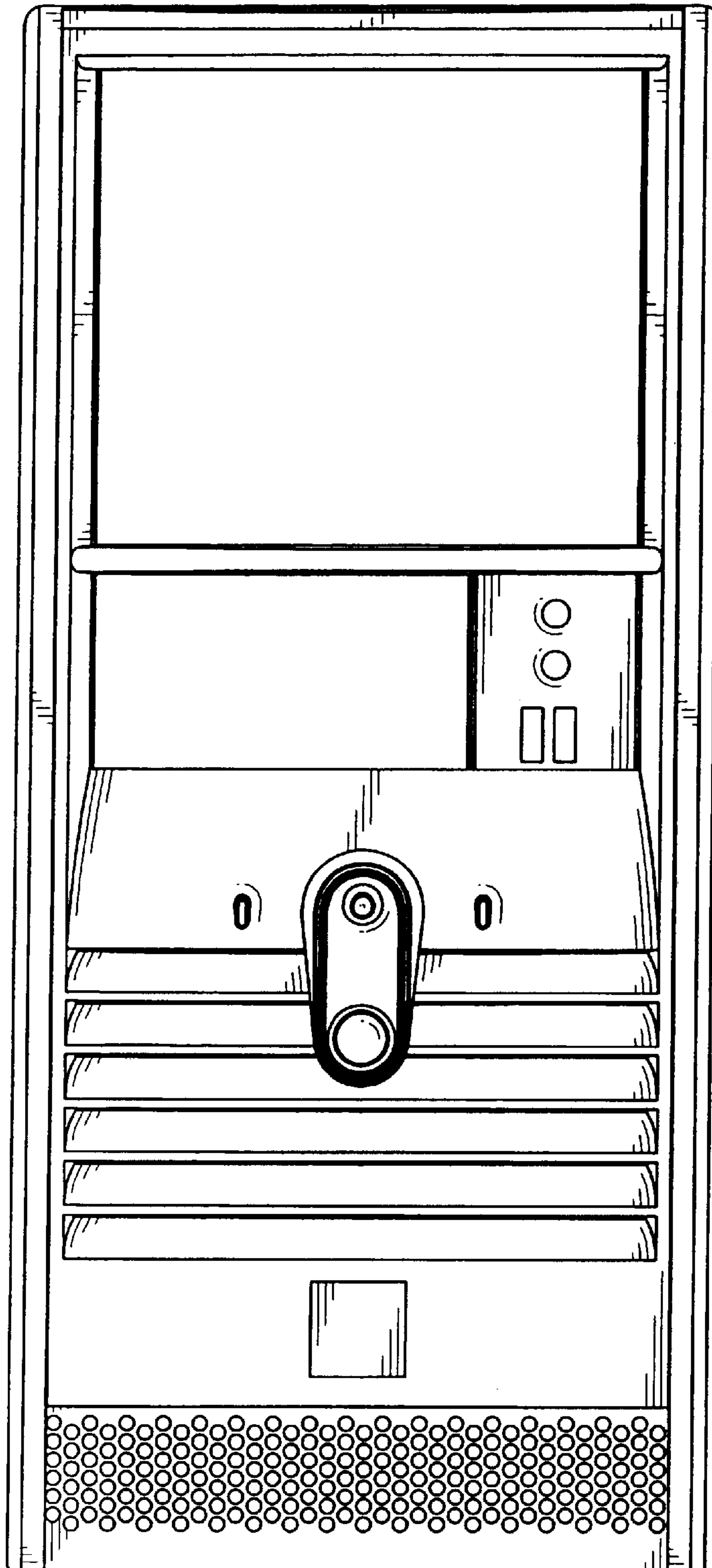

FIG. 2

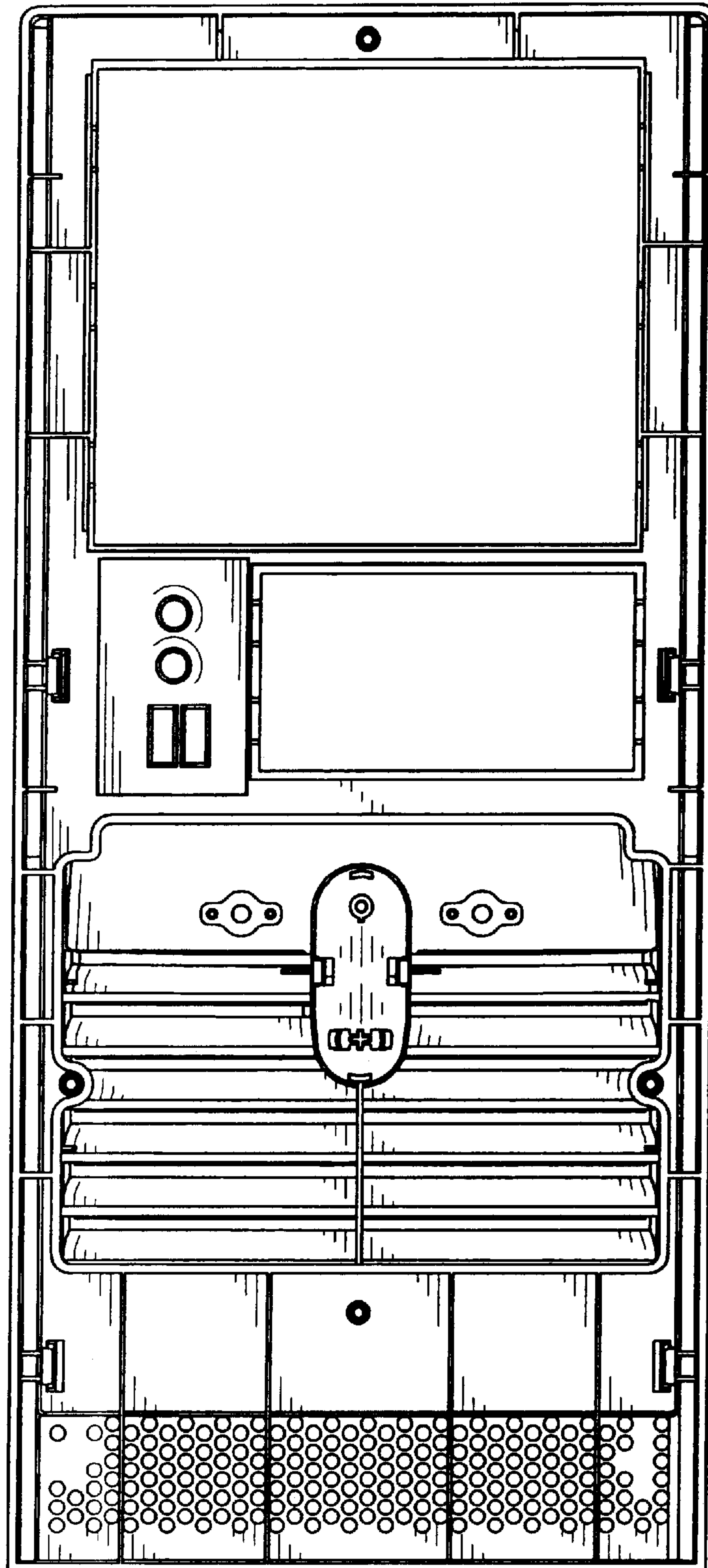

FIG. 3

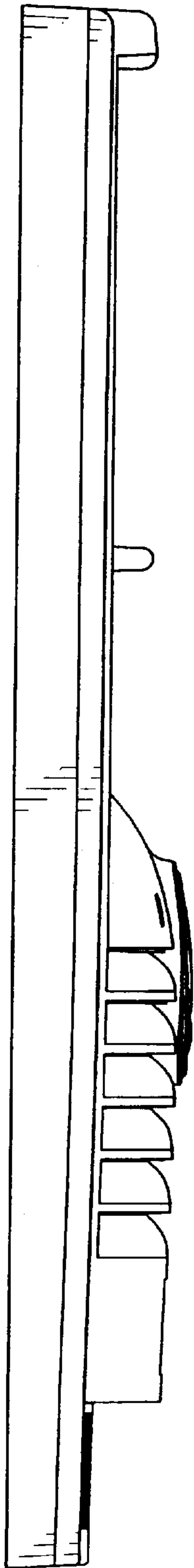

FIG. 4

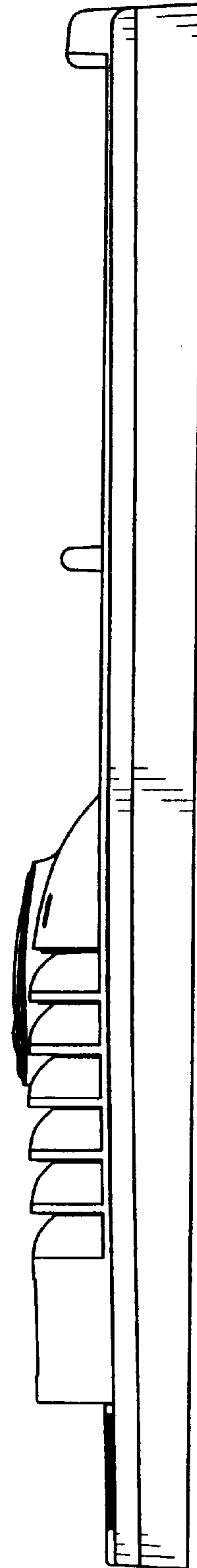

FIG. 5

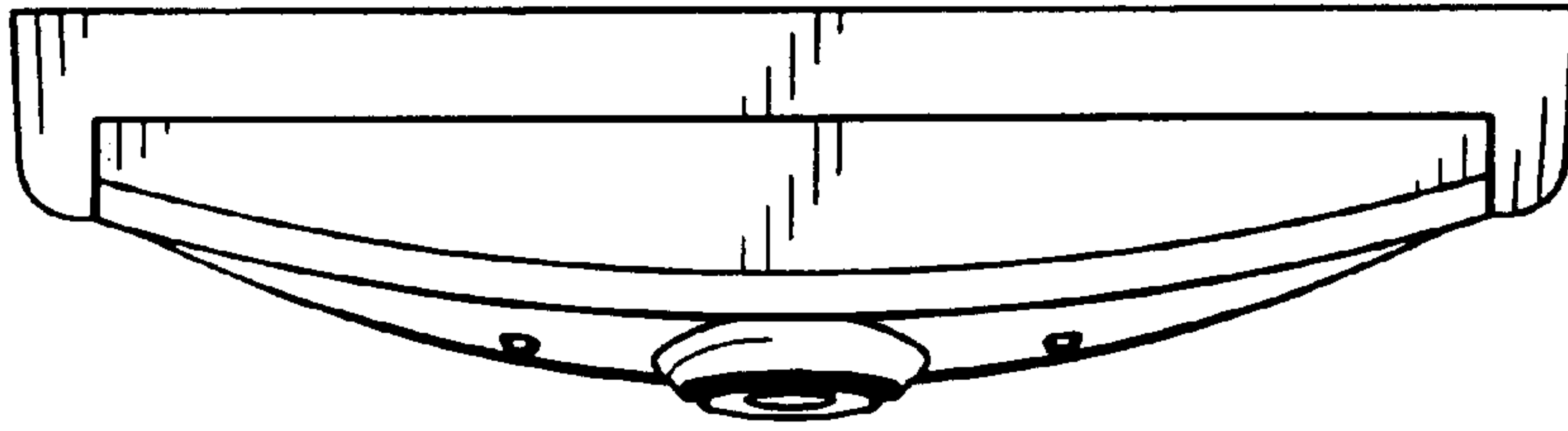

FIG. 6

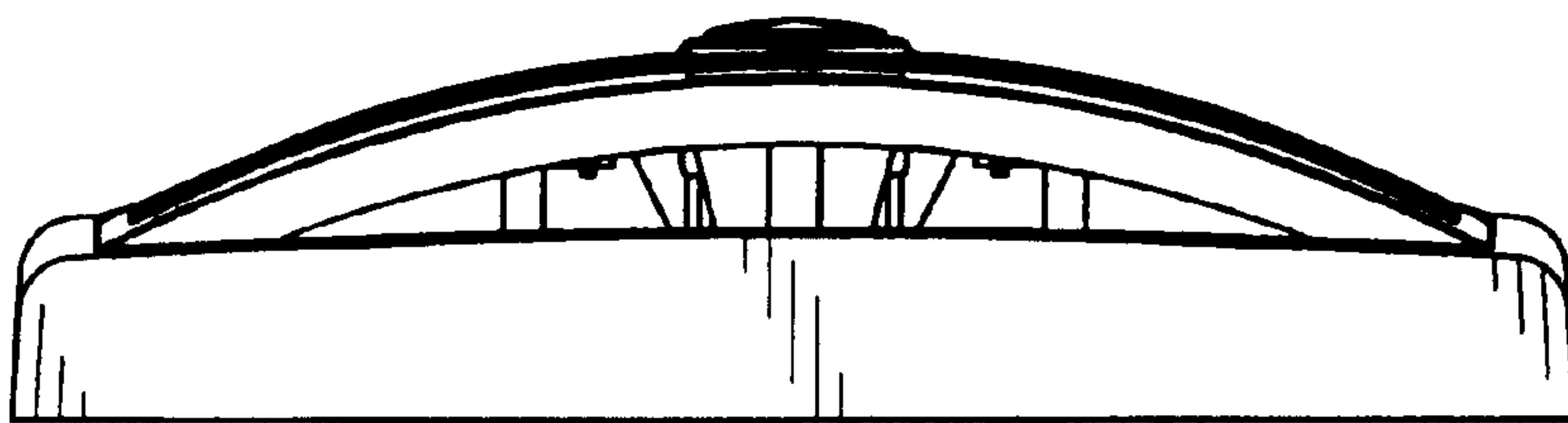

FIG. 7

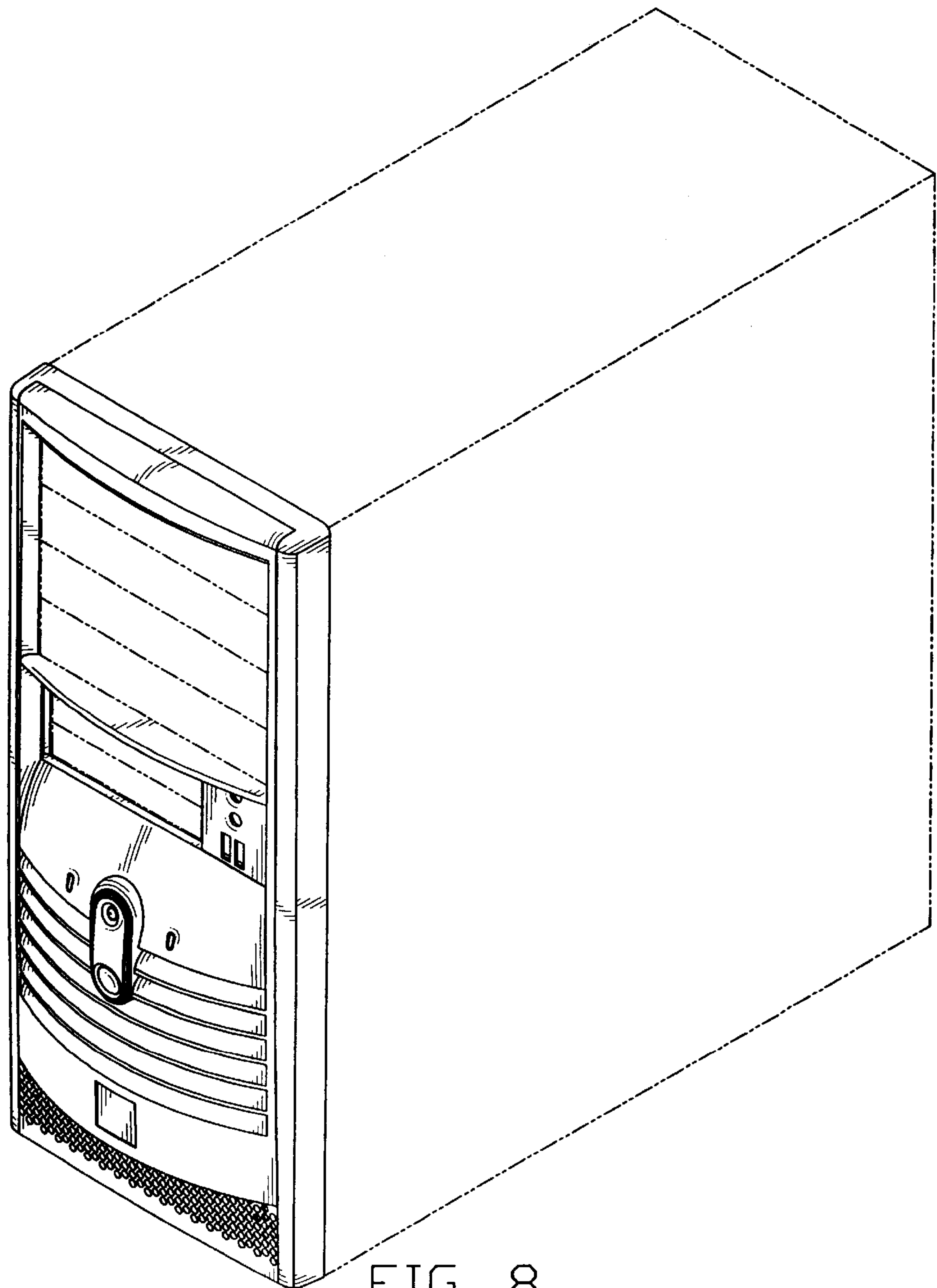

FIG. 8