



US00D489716S

(12) **United States Design Patent**  
**Kim**

(10) **Patent No.:** **US D489,716 S**

(45) **Date of Patent:** **\*\* May 11, 2004**

(54) **MULTIMEDIA COMPUTER**

D455,745 S \* 4/2002 Kim ..... D14/337

(75) Inventor: **Yong-Nam Kim**, Seongnam (KR)

\* cited by examiner

(73) Assignee: **UM Digital, Inc.**, Seoul (KR)

*Primary Examiner*—Freda Nunn

(\*\*) Term: **14 Years**

(74) *Attorney, Agent, or Firm*—Gifford, Krass, Groh, Sprinkle, Anderson & Citkowski, P.C.

(21) Appl. No.: **29/174,599**

(57) **CLAIM**

(22) Filed: **Jan. 21, 2003**

The ornamental design for the multimedia computer, as shown and described.

(30) **Foreign Application Priority Data**

**DESCRIPTION**

Oct. 7, 2002 (KR) ..... 30-2002-0028422

(51) **LOC (7) Cl.** ..... **14-02**

(52) **U.S. Cl.** ..... **D14/336**

(58) **Field of Search** ..... D14/336, 337,  
D14/371, 373, 125–129; 345/104, 156,  
168, 173, 901–905; 348/180, 184, 325,  
739; 341/12; 349/1, 2, 11, 62; 248/122.1

FIG. 1 is a front elevational view of the design for a multimedia computer;

FIG. 2 is a rear elevational view of the design of FIG. 1;

FIG. 3 is a left side elevational view of the design of FIG. 1;

FIG. 4 is a right side elevational view of the design of FIG. 1;

FIG. 5 is a top plan view of the design of FIG. 1;

FIG. 6 is a bottom plan view of the design of FIG. 1; and,

FIG. 7 is a top, front, right side perspective view of the design of FIG. 1.

The surface(s) or portion(s) of the article not shown in the drawing or described in the specification form(s) no part of the claimed design.

(56) **References Cited**

**U.S. PATENT DOCUMENTS**

- D273,867 S \* 5/1984 Sanders et al. .... D14/336
- 5,687,939 A \* 11/1997 Moscovitch ..... 248/122.1
- D448,024 S \* 9/2001 Kim ..... D14/337
- D448,370 S \* 9/2001 Kim ..... D14/337
- D448,371 S \* 9/2001 Kim ..... D14/337

**1 Claim, 4 Drawing Sheets**

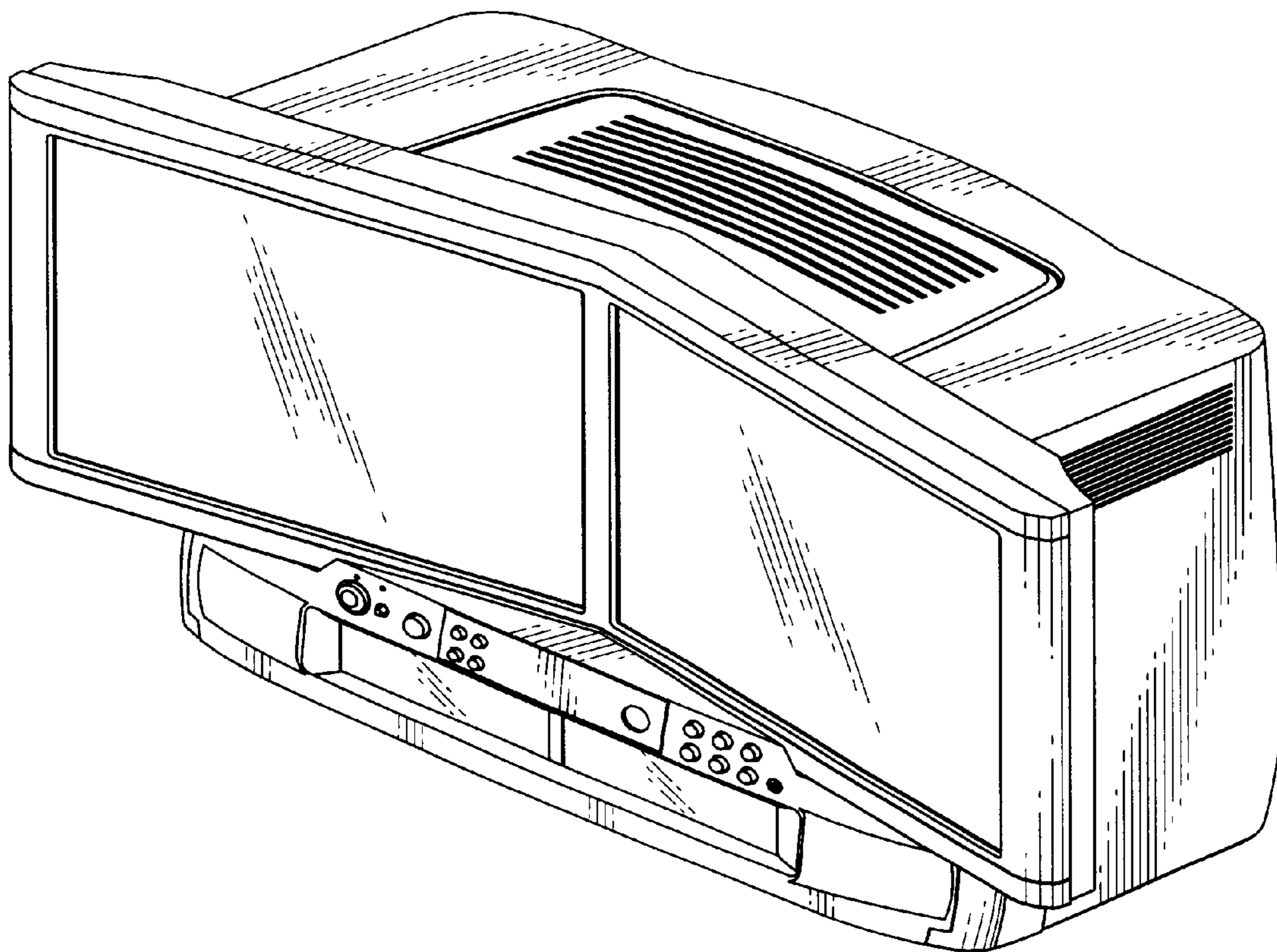

Fig.1

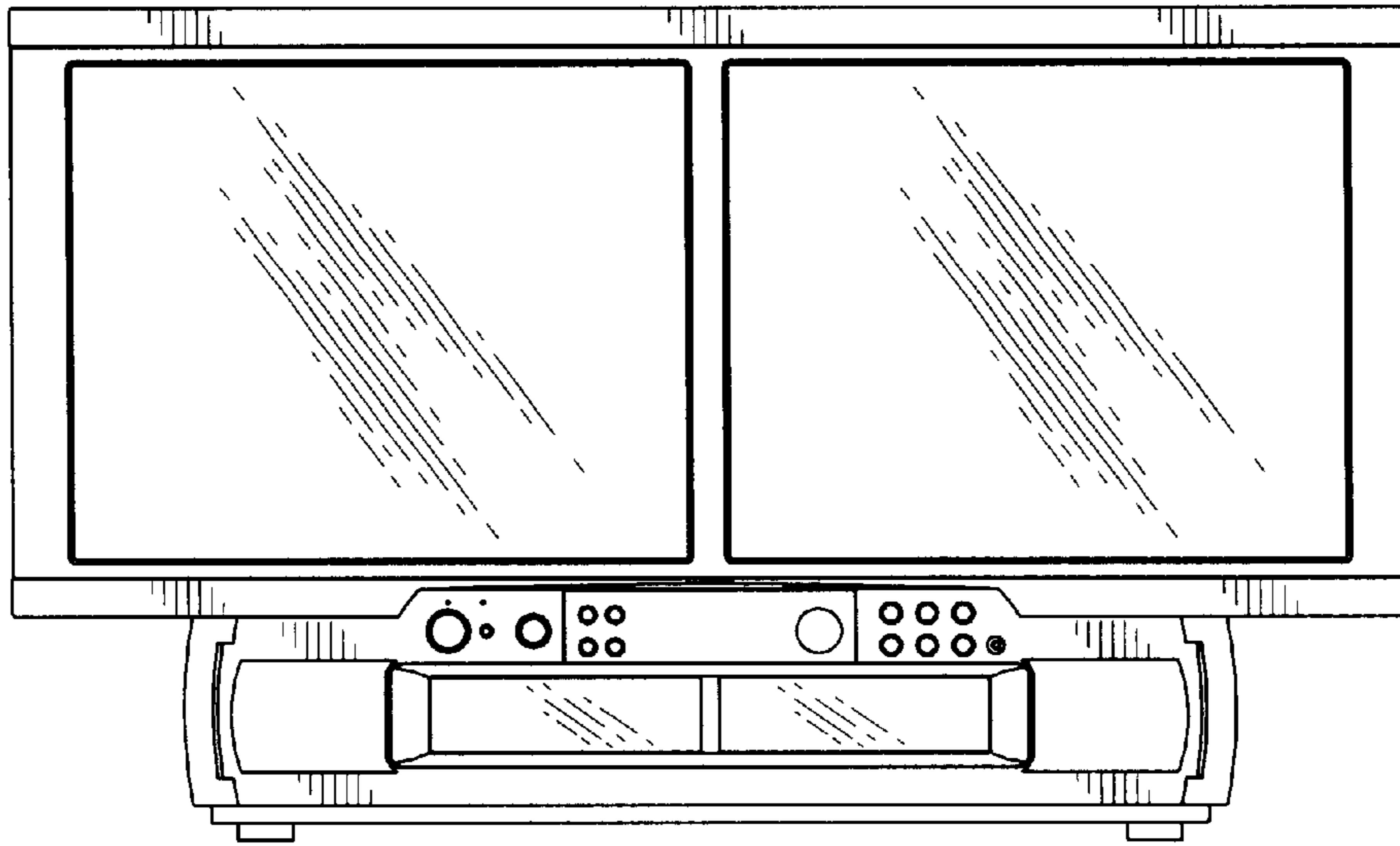

Fig.2

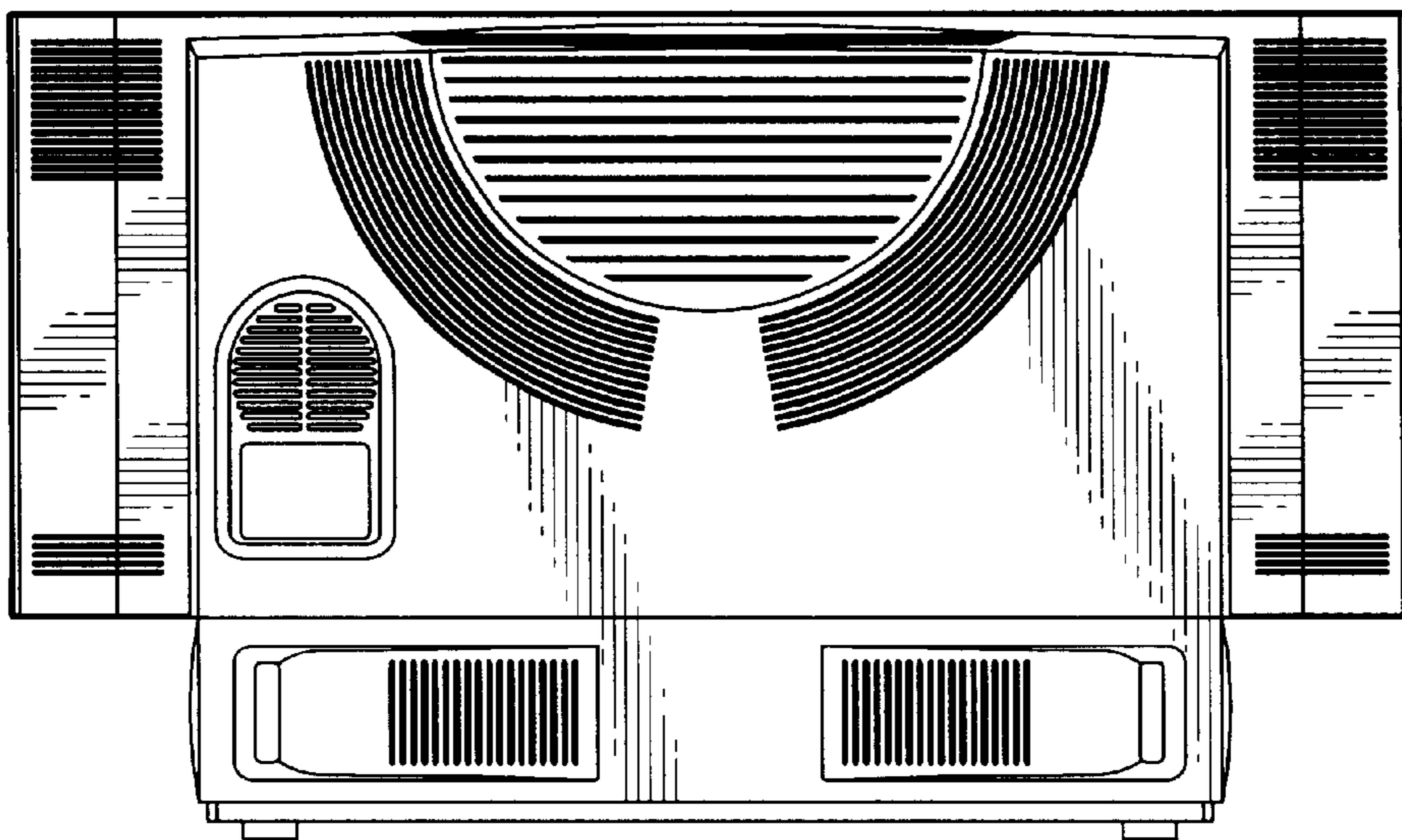

Fig.3

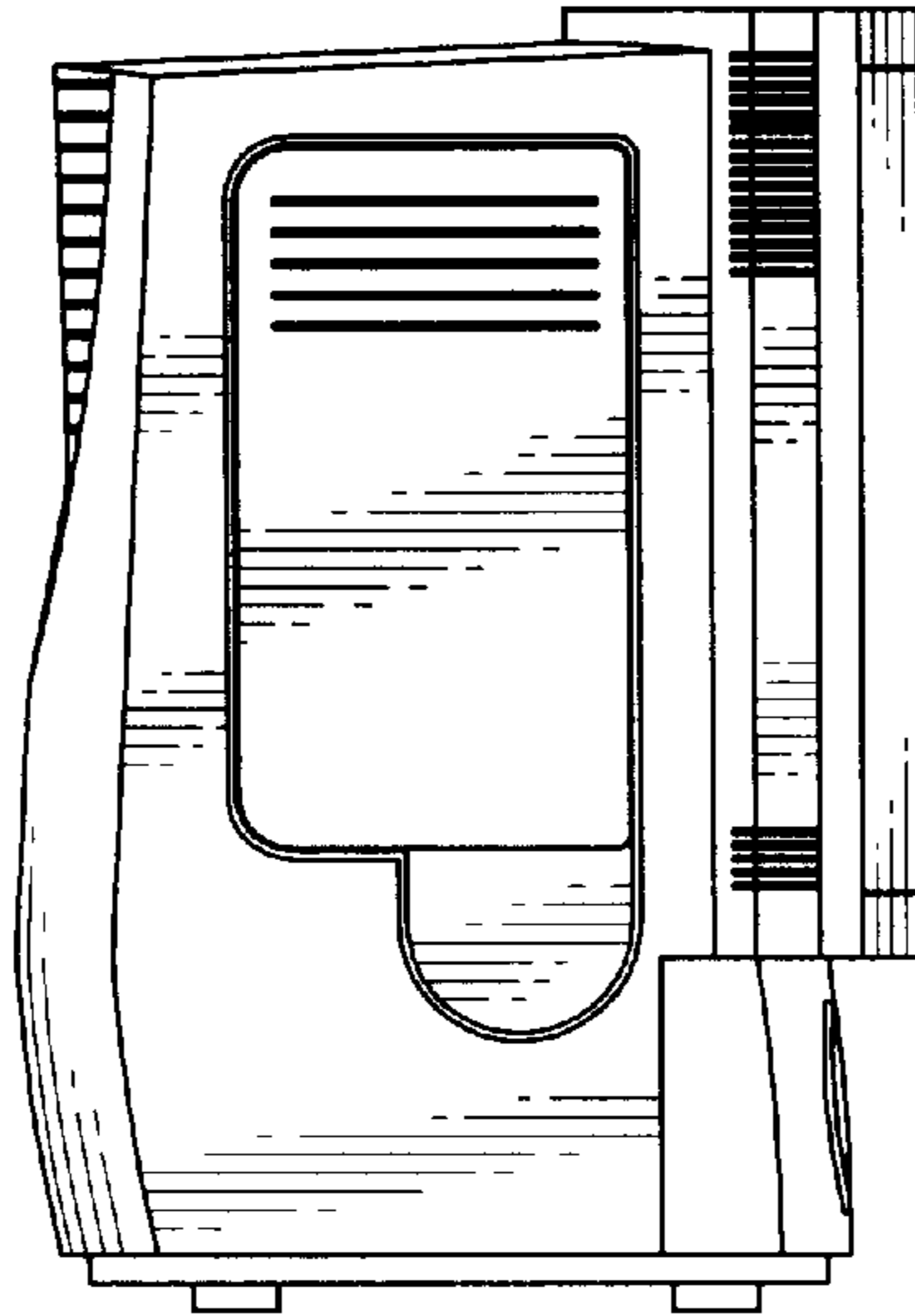

Fig.4

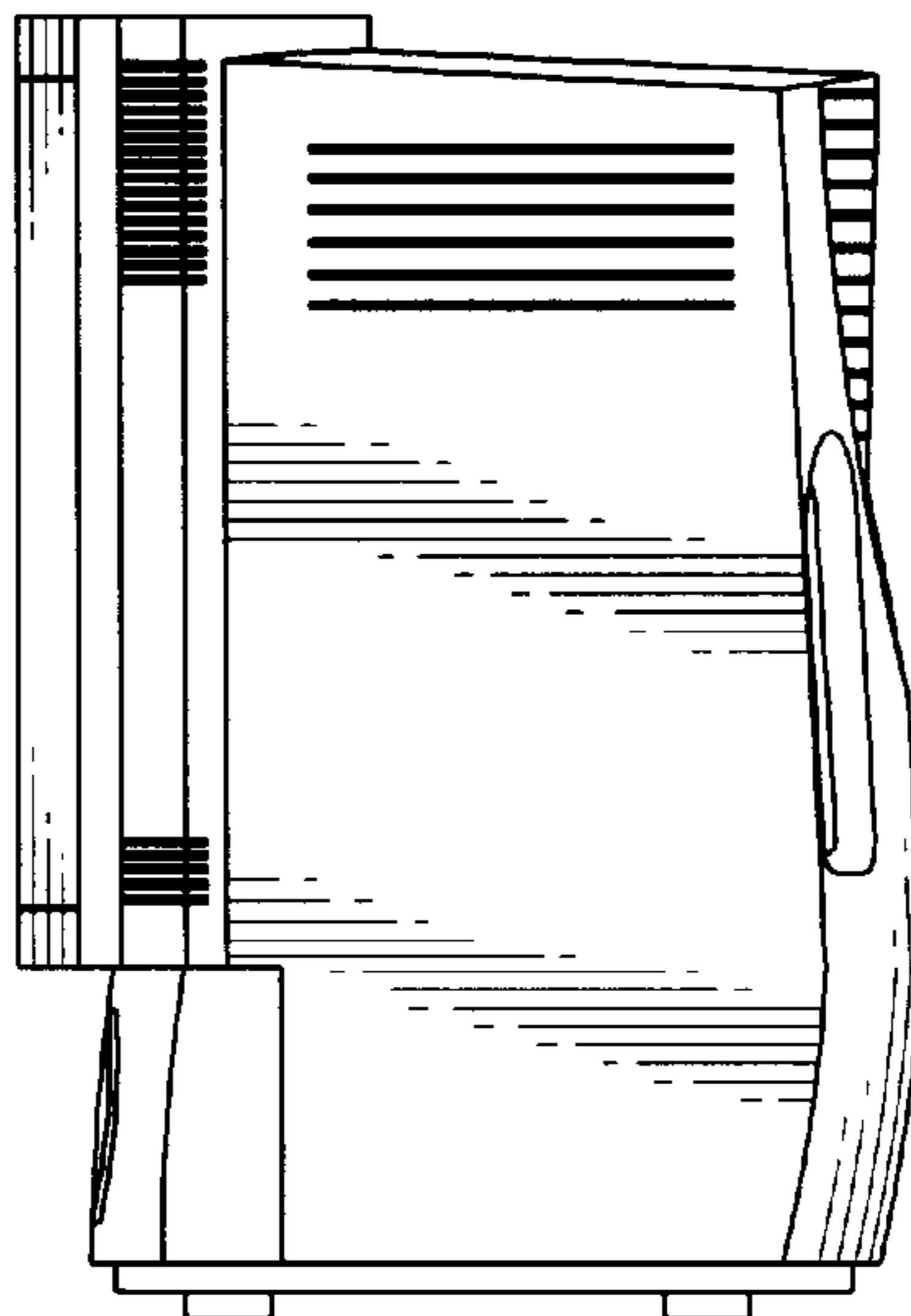

Fig.5

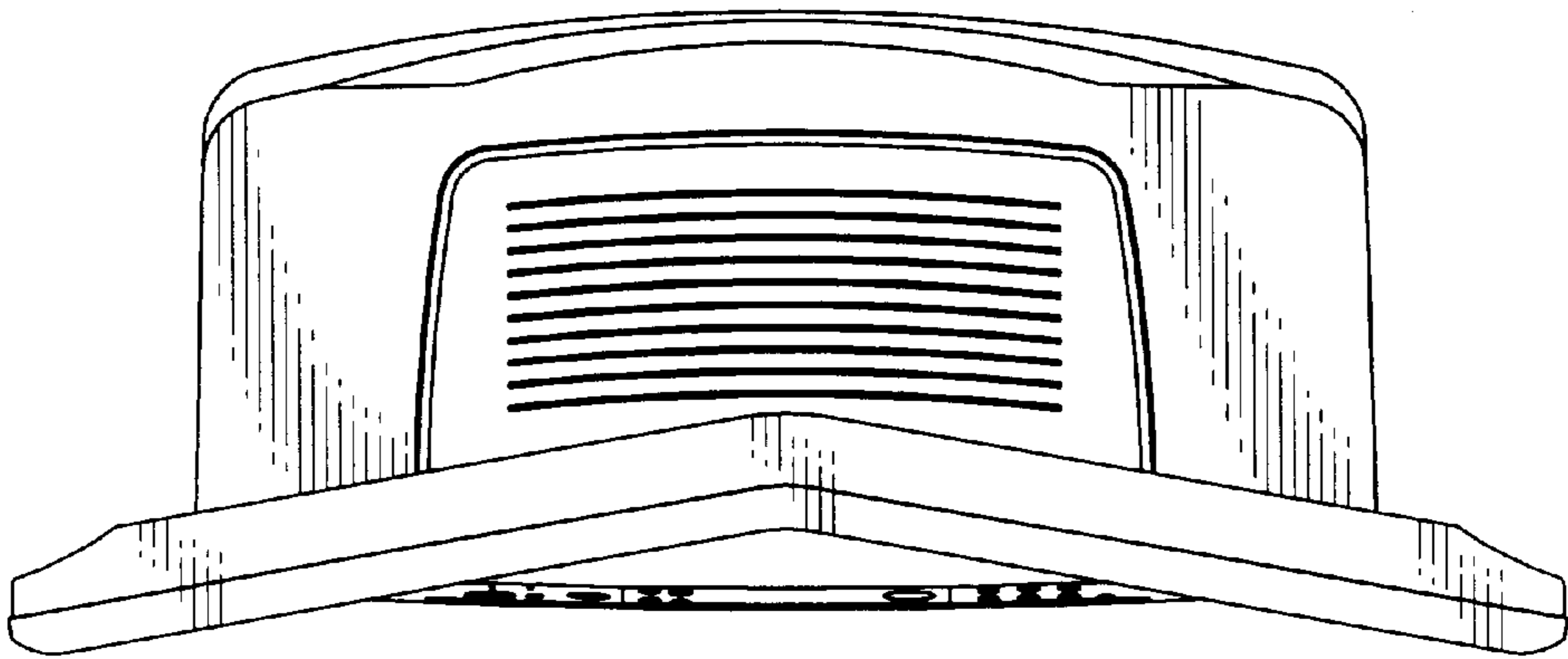

Fig.6

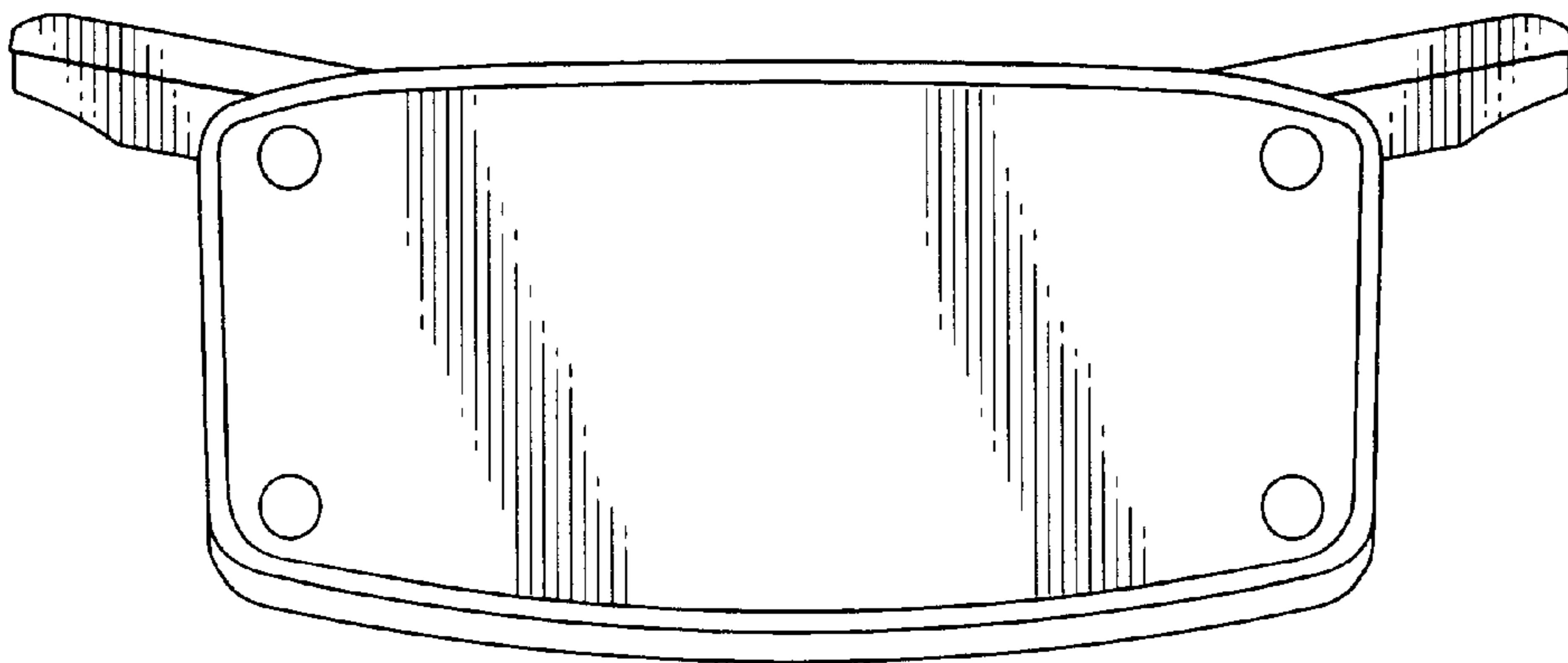

Fig.7

