



US00D489680S

(12) **United States Design Patent**
Stobart

(10) **Patent No.:** **US D489,680 S**

(45) **Date of Patent:** **** May 11, 2004**

(54) **BATTERY CHARGER**

(75) Inventor: **Jonathan Stobart**, Oxon (GB)

(73) Assignee: **Smart Solar Limited**, Banbury (GB)

(**) Term: **14 Years**

(21) Appl. No.: **29/185,680**

(22) Filed: **Jun. 27, 2003**

(51) **LOC (7) Cl.** **13-02**

(52) **U.S. Cl.** **D13/107; D13/102**

(58) **Field of Search** **D13/107, 108, D13/102; D14/253; 320/107-115, 101**

(56) **References Cited**

U.S. PATENT DOCUMENTS

D278,703 S	*	5/1985	Chiodo et al.	D13/107
D348,427 S	*	7/1994	Ohmaki et al.	D13/107
D370,202 S	*	5/1996	Youens	D13/107
5,522,943 A	*	6/1996	Spencer et al.	D13/102
D373,992 S	*	9/1996	Rosen et al.	D13/107
D375,934 S	*	11/1996	Rosen et al.	D13/107
D395,279 S	*	6/1998	Peress et al.	D13/107
D400,162 S	*	10/1998	Lam	D13/107
D412,487 S	*	8/1999	Nagele et al.	D13/108
6,476,311 B1	*	11/2002	Lee et al.	320/101

D479,191 S * 9/2003 Peress et al. D13/102
6,650,085 B2 * 11/2003 Lau et al. 320/101

* cited by examiner

Primary Examiner—Joel Sincavage

(57) **CLAIM**

The ornamental design for a battery charger, as shown.

DESCRIPTION

FIG. 1 is a front elevational view of a battery charger showing my new design;
 FIG. 2 is a rear elevational view thereof;
 FIG. 3 is a left side elevational view thereof;
 FIG. 4 is a right side elevational view thereof;
 FIG. 5 is a top plan view thereof;
 FIG. 6 is a bottom plan view thereof;
 FIG. 7 is a front view thereof with cover being opened;
 FIG. 8 is a left side view thereof with cover being opened;
 FIG. 9 is a right side view thereof with cover being opened;
 FIG. 10 is a rear view thereof with cover being opened;
 FIG. 11 is a top plan view thereof with cover being opened;
 and,
 FIG. 12 is a bottom plan view thereof with cover being opened.

1 Claim, 4 Drawing Sheets

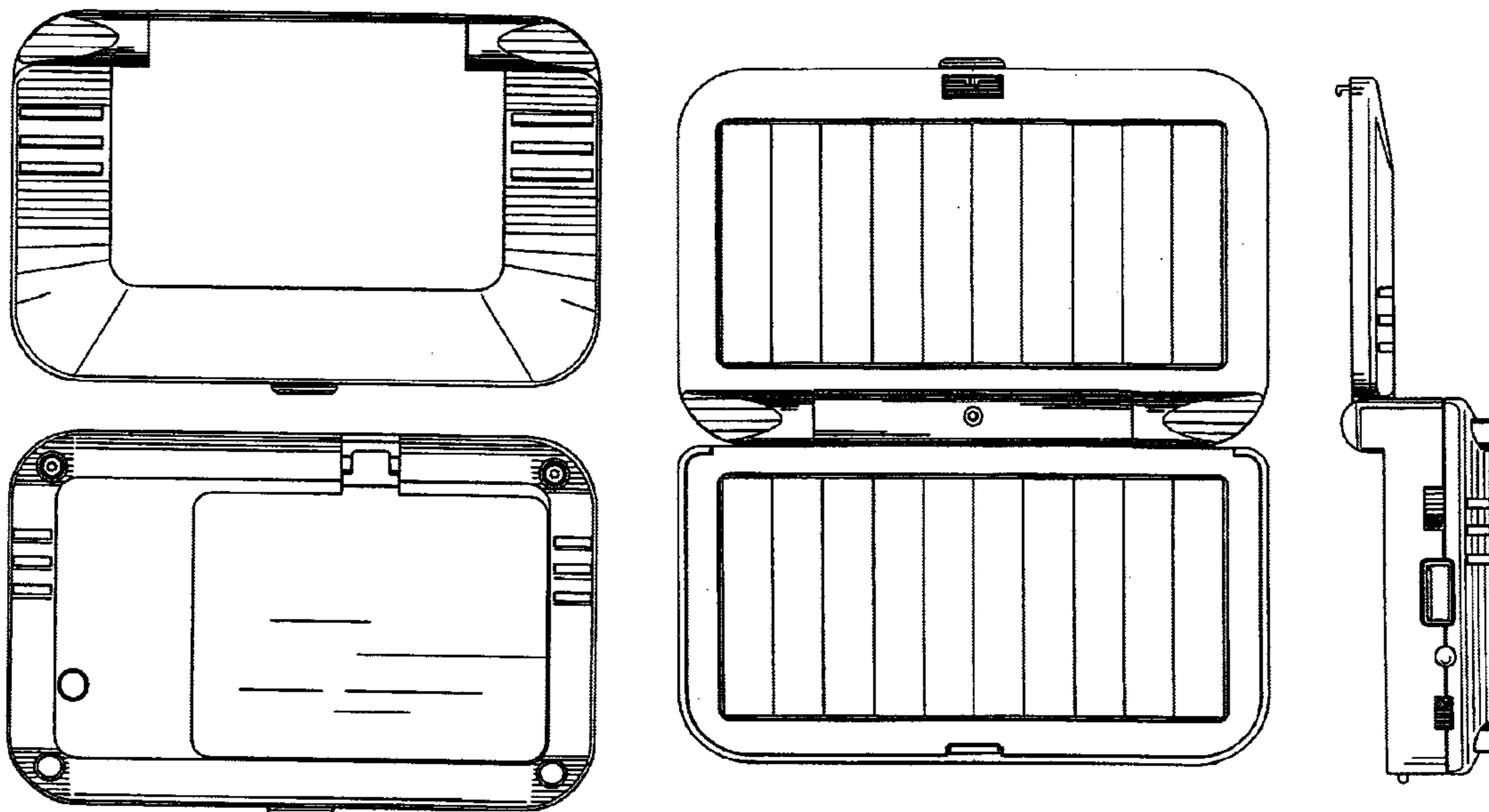

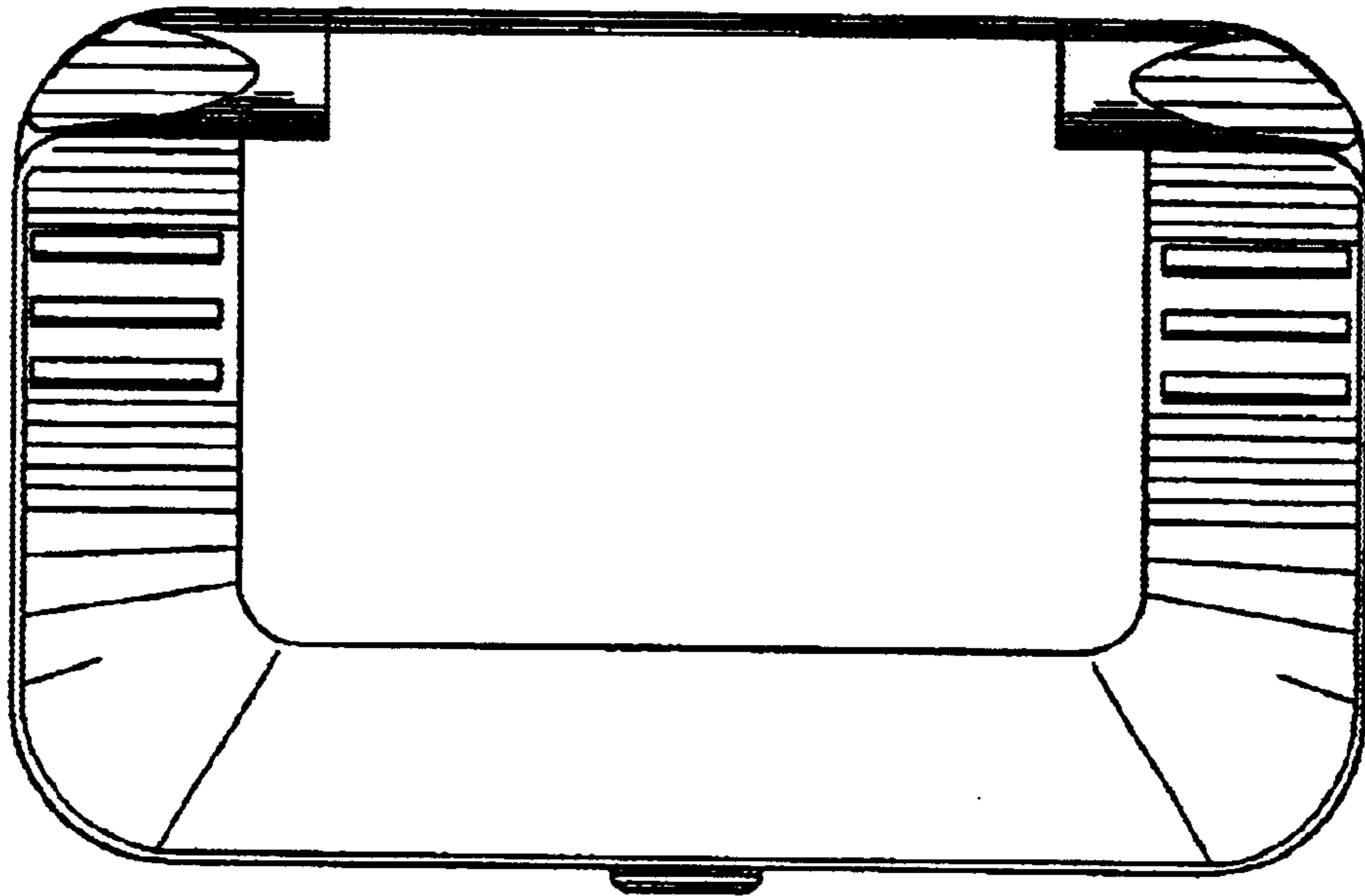

FIG. 1

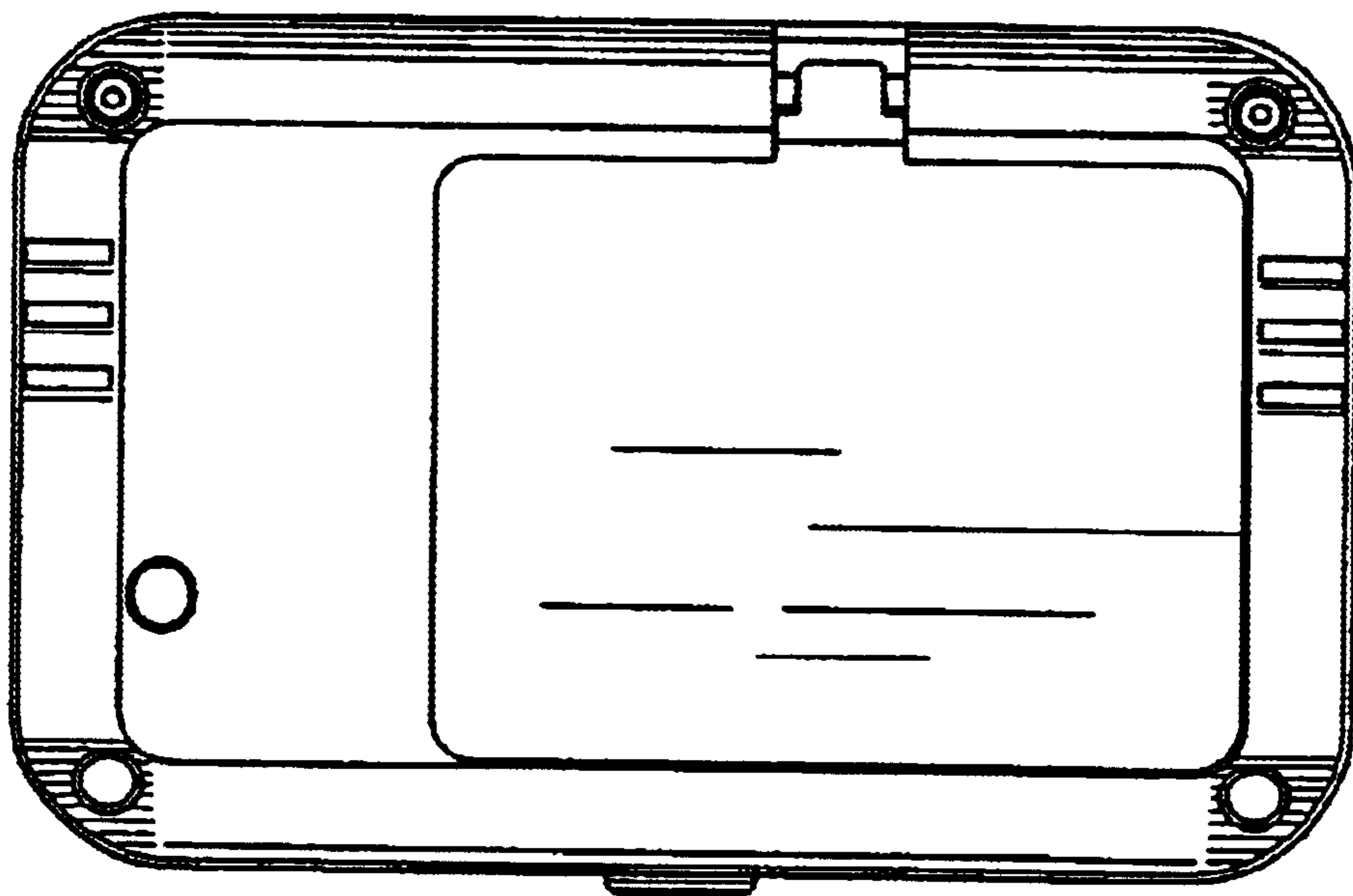

FIG. 2

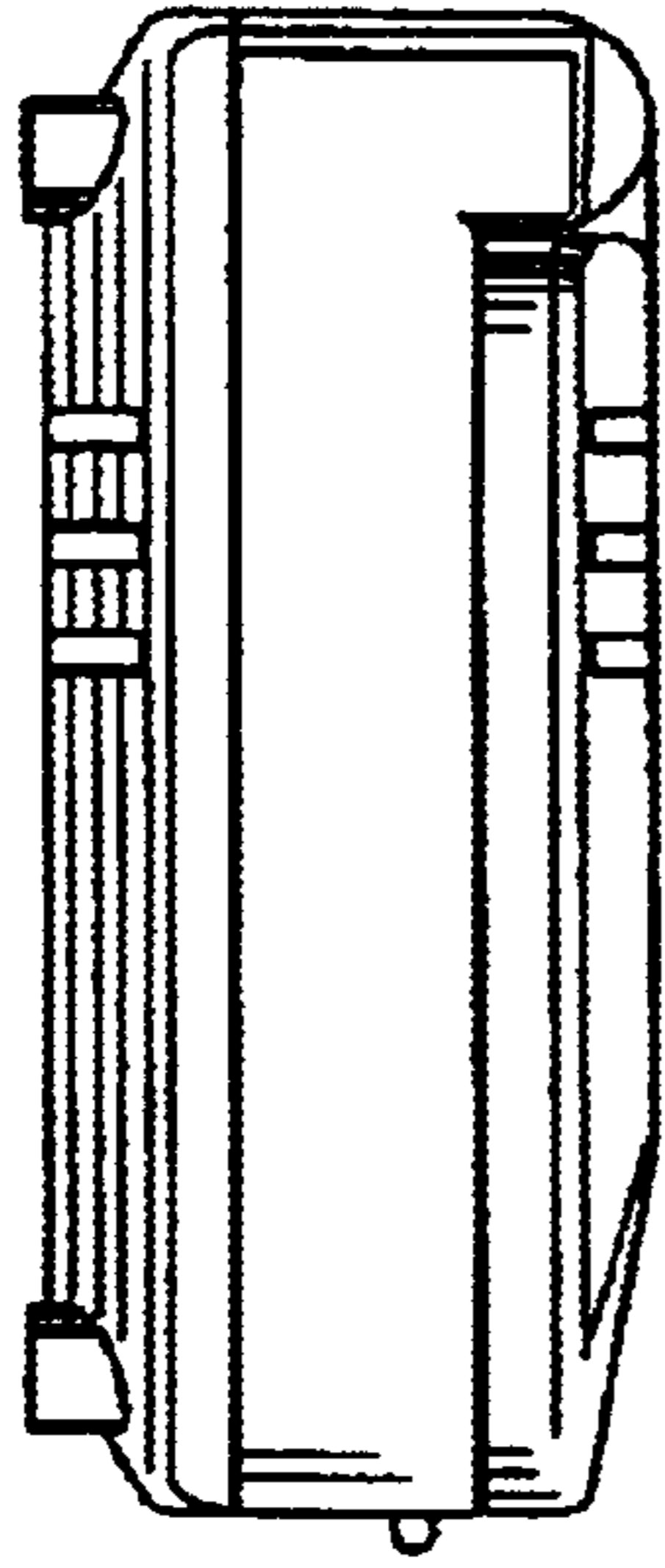

FIG. 3

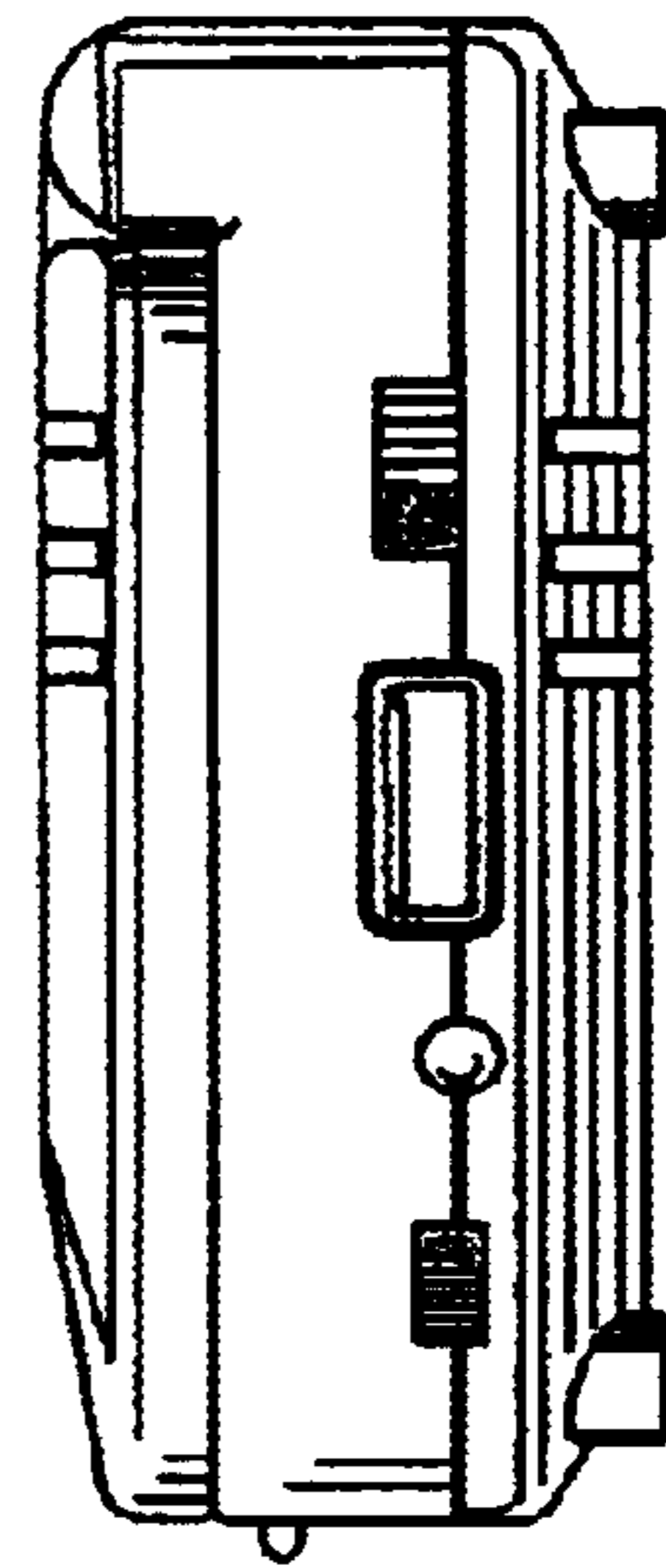

FIG. 4

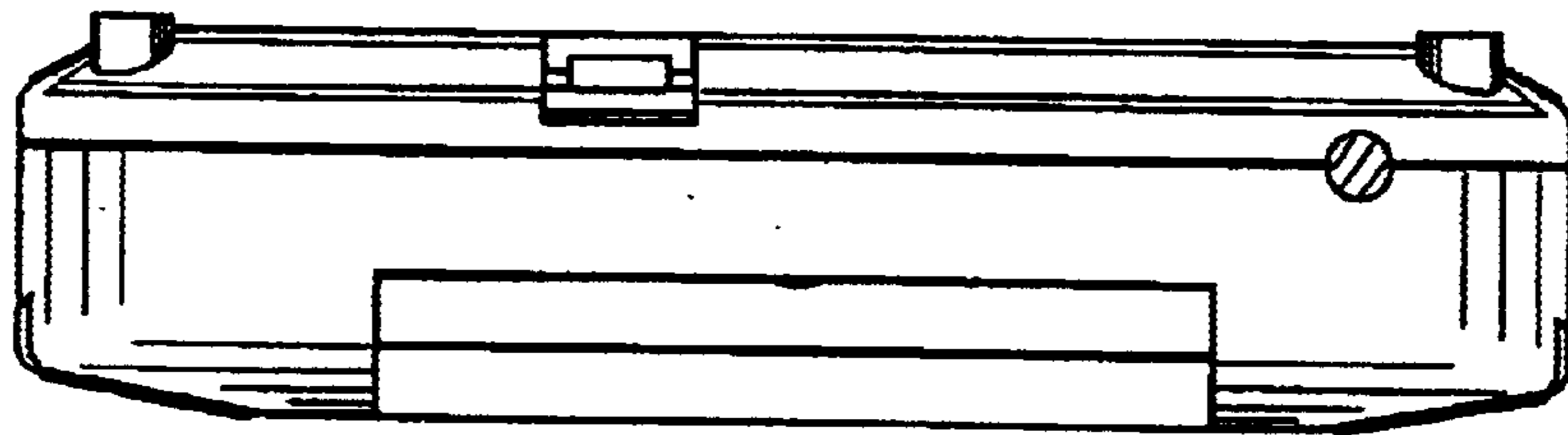

FIG. 5

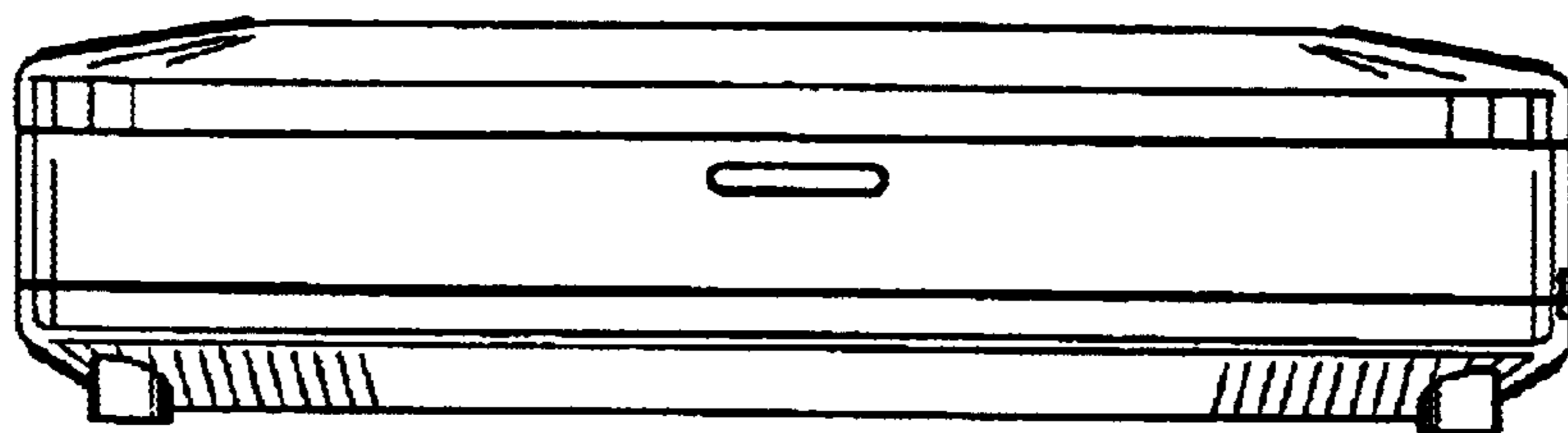

FIG. 6

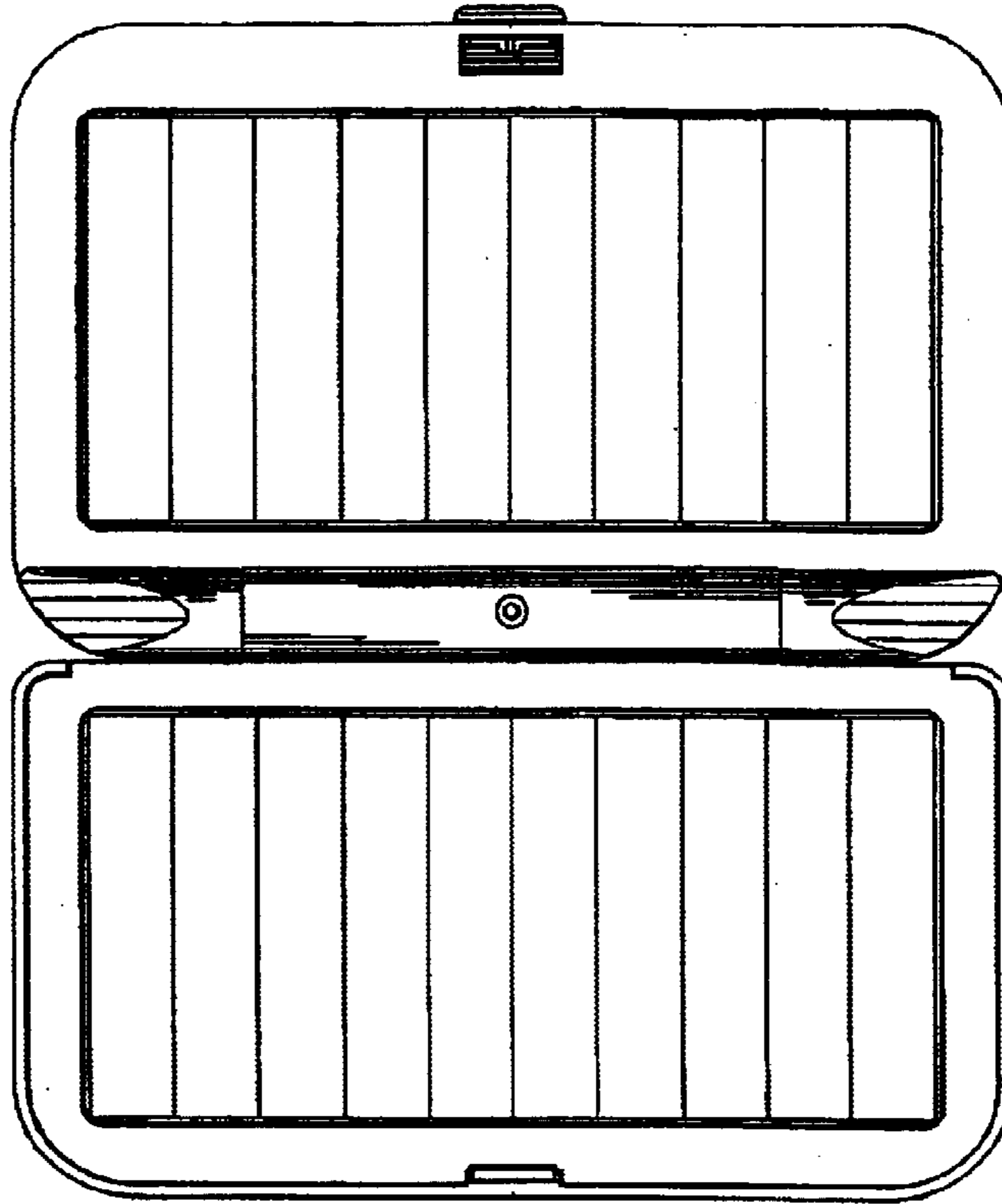

FIG. 7

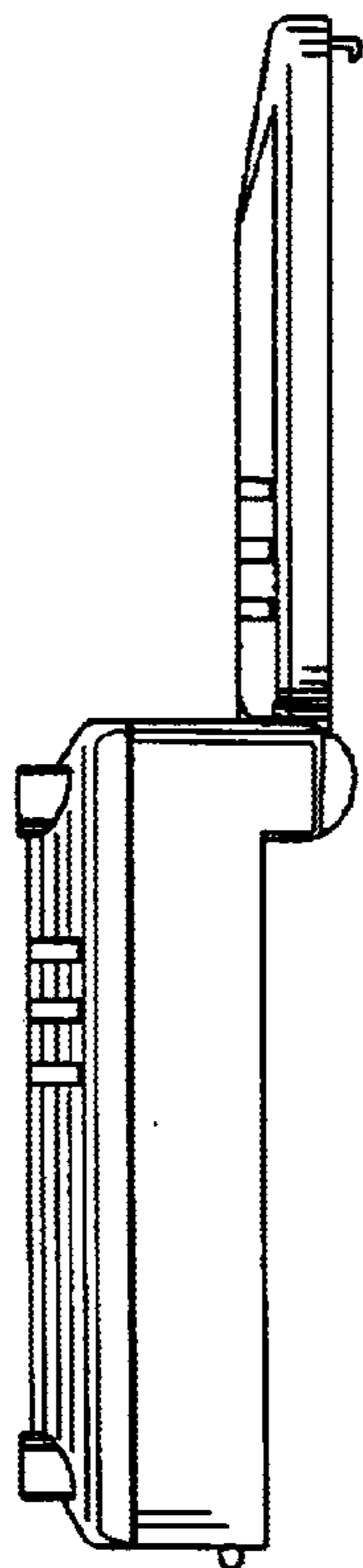

FIG. 8

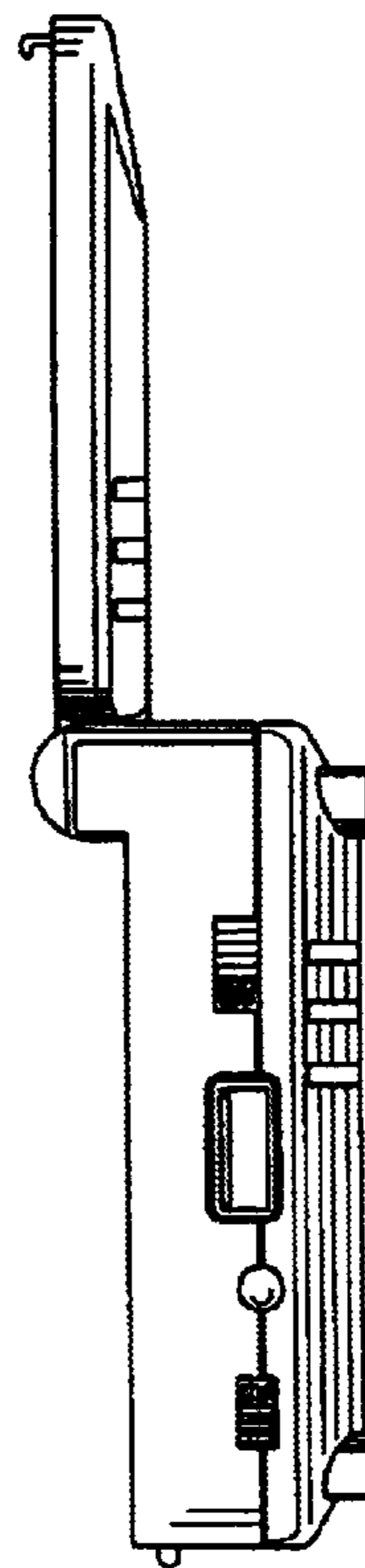

FIG. 9

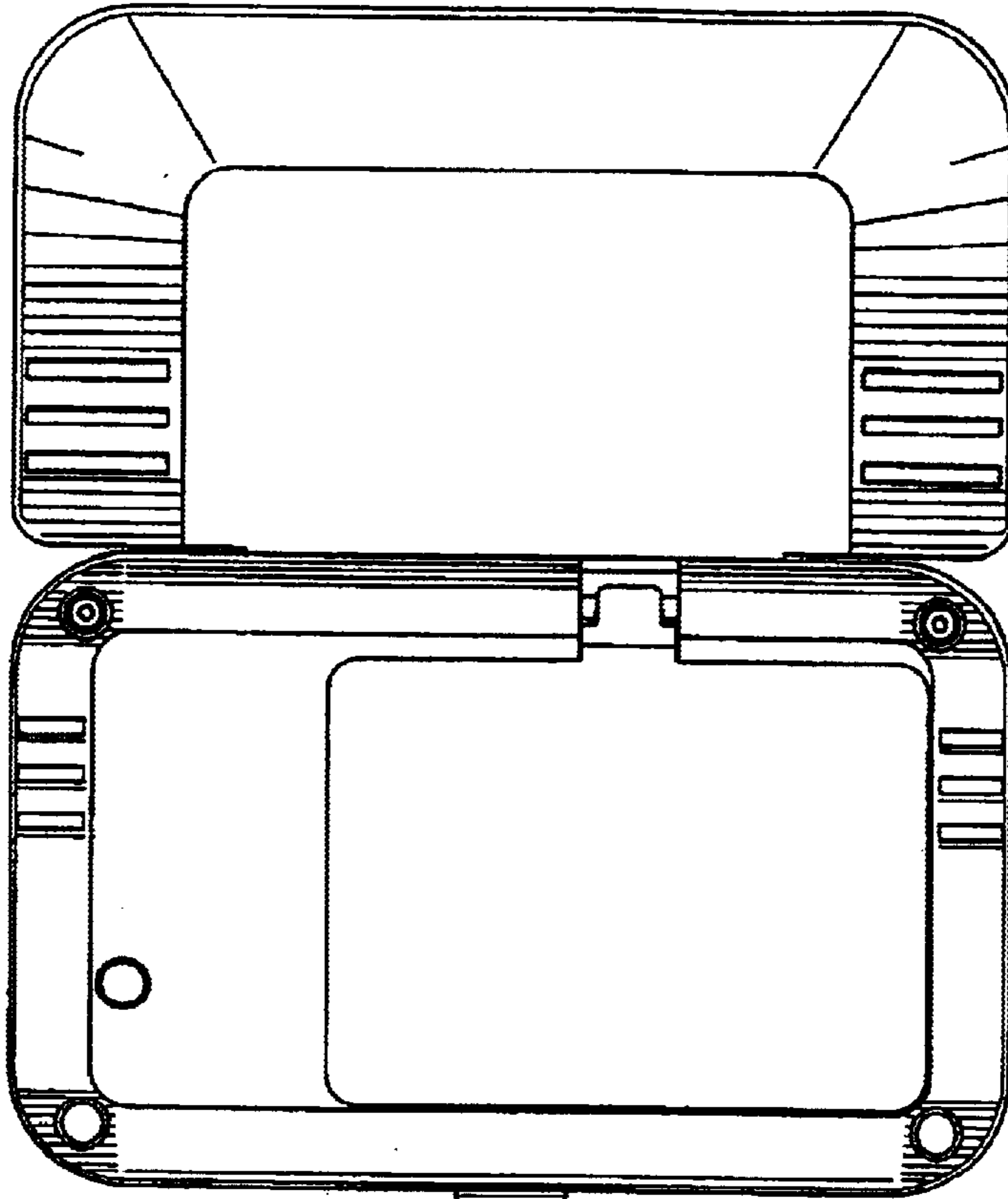

FIG. 10

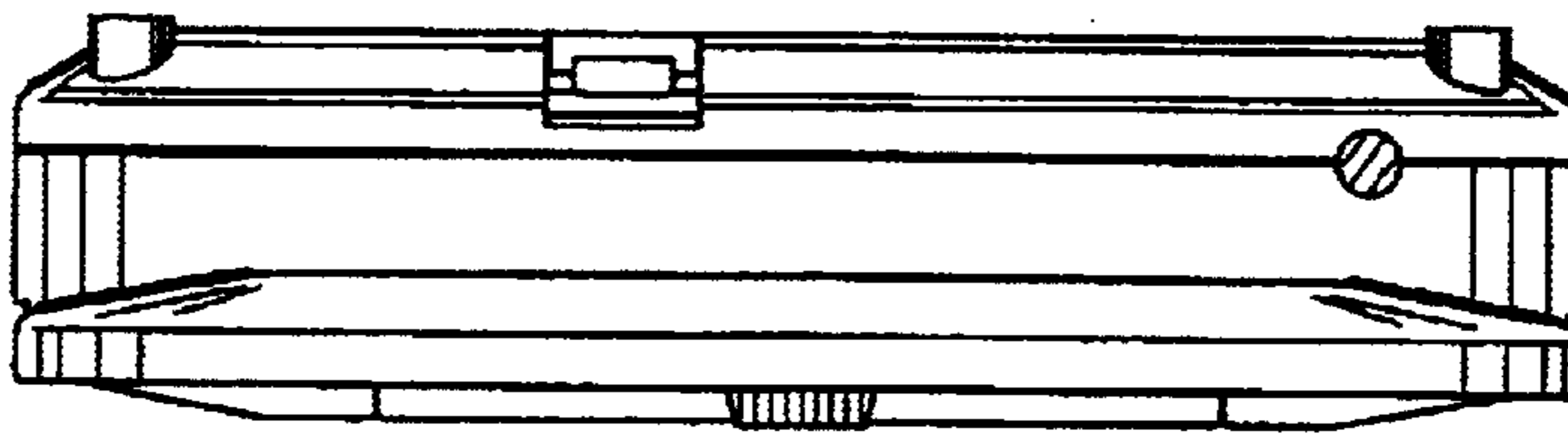

FIG. 11

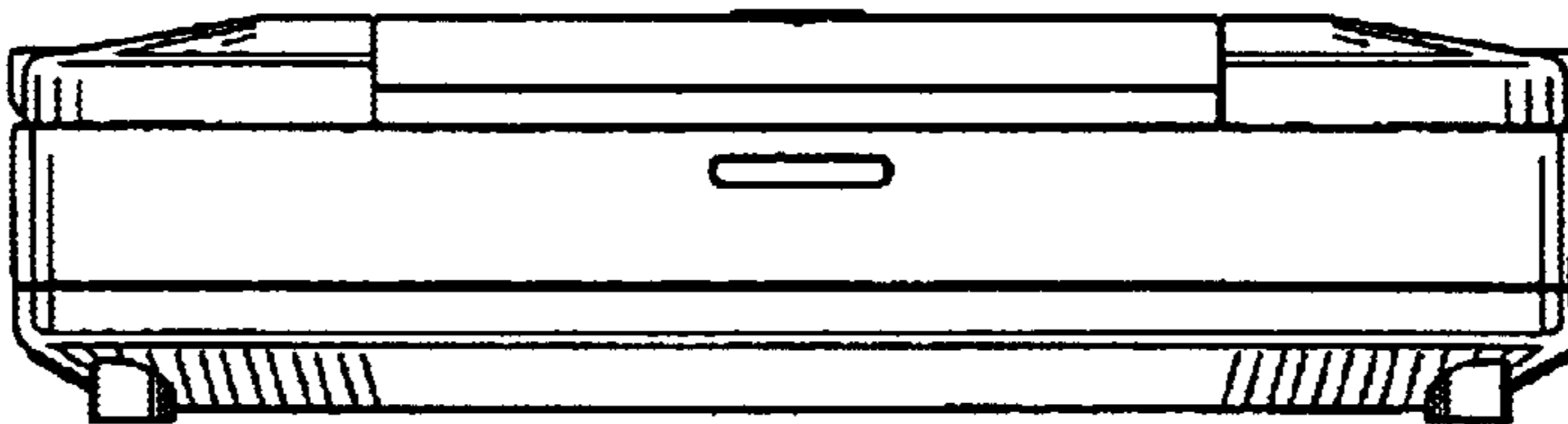

FIG. 12