



US00D489570S

(12) **United States Design Patent**
Feil

(10) **Patent No.:** **US D489,570 S**

(45) **Date of Patent:** **** May 11, 2004**

(54) **BLENDER BASE**

(75) **Inventor:** **Rolf Feil, Günzburg (DE)**

(73) **Assignee:** **BSH Bosch und Siemens Hausgerate GmbH, Munich (DE)**

(**) **Term:** **14 Years**

(21) **Appl. No.:** **29/187,424**

(22) **Filed:** **Jul. 28, 2003**

(30) **Foreign Application Priority Data**

Jan. 31, 2003 (DE) 4 03 00 895

(51) **LOC (7) Cl.** **31-00**

(52) **U.S. Cl.** **D7/386**

(58) **Field of Search** D7/376-386; 241/30,
241/33, 101.01-101.2, 274, 277, 285.1-285.3;
366/64-67, 129, 130, 197-207, 219-221,
241-254, 341

(56) **References Cited**

U.S. PATENT DOCUMENTS

- D181,541 S * 11/1957 Madl et al. D7/378
- D191,344 S * 9/1961 Leman et al. D7/378
- D213,938 S * 4/1969 Morris D7/378

- D216,237 S * 12/1969 Levin D7/386
- D272,120 S * 1/1984 Sawada et al. D7/384
- D339,715 S * 9/1993 Barrault D7/378
- D374,375 S * 10/1996 Breur et al. D7/386
- D389,696 S * 1/1998 Feil D7/386
- D404,606 S * 1/1999 Huang D7/378

* cited by examiner

Primary Examiner—Caron D. Veynar

(74) *Attorney, Agent, or Firm*—Laurence A. Greenberg;
Werner H. Stemer; Gregory L. Mayback

(57) **CLAIM**

The ornamental design for a blender base, as shown and described.

DESCRIPTION

FIG. 1 is a top front perspective view of the blender base;
FIG. 2 is a rear bottom perspective view thereof;
FIG. 3 is a front side view thereof;
FIG. 4 is a rear side view thereof;
FIG. 5 is a top side view thereof;
FIG. 6 is a bottom side view thereof;
FIG. 7 is a left side view thereof; and,
FIG. 8 is right side view thereof.

1 Claim, 4 Drawing Sheets

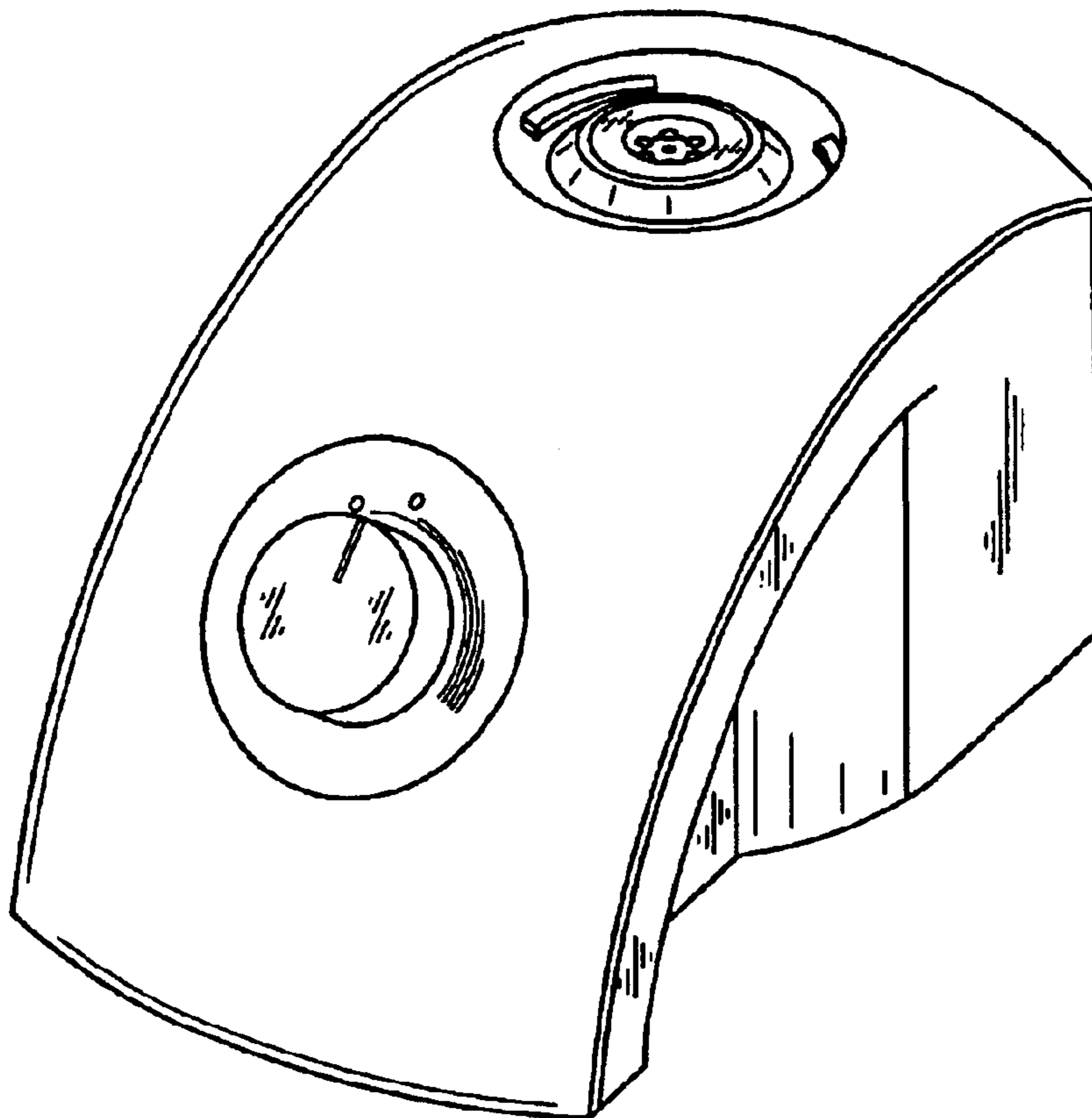

Fig. 1

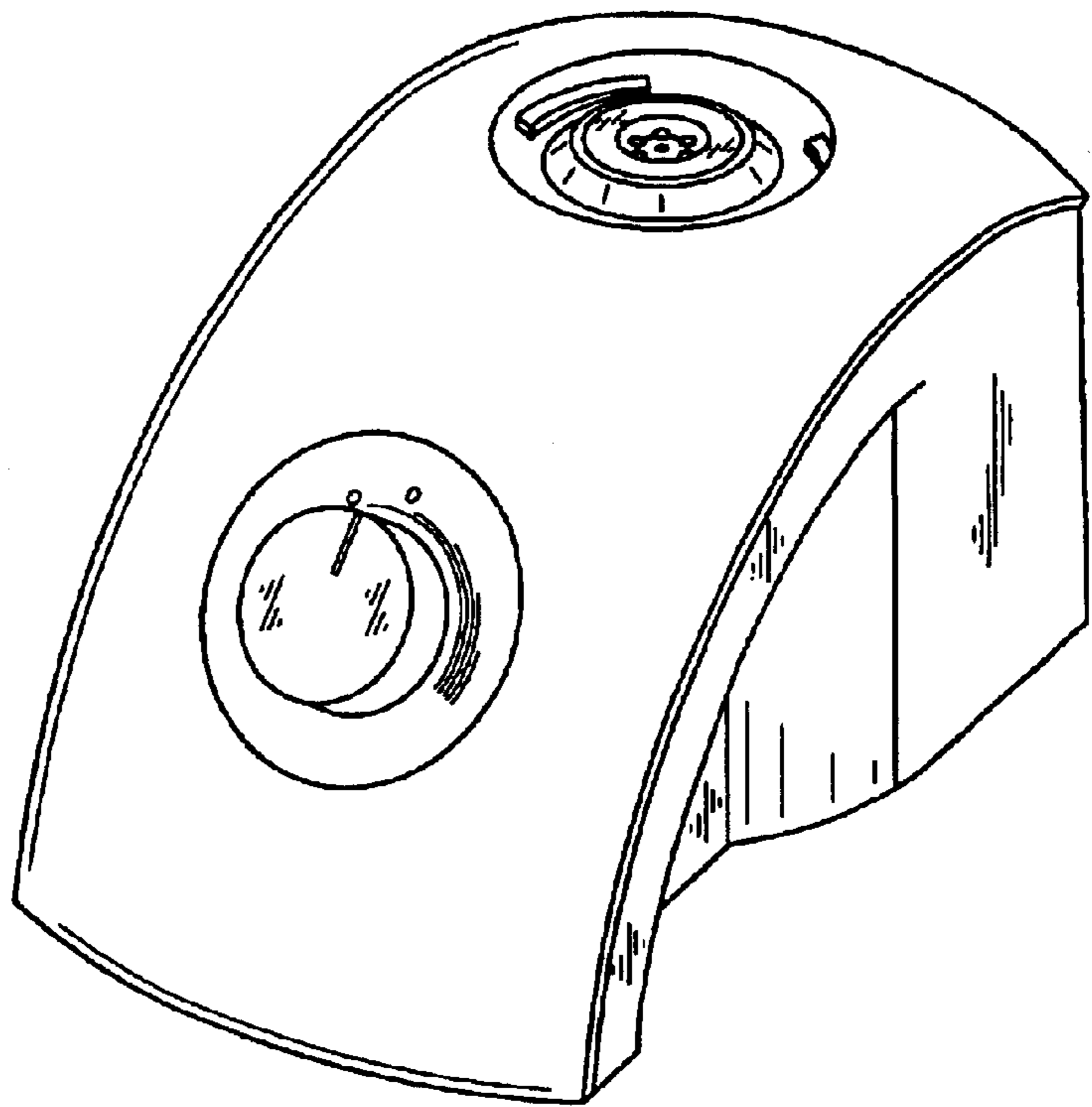
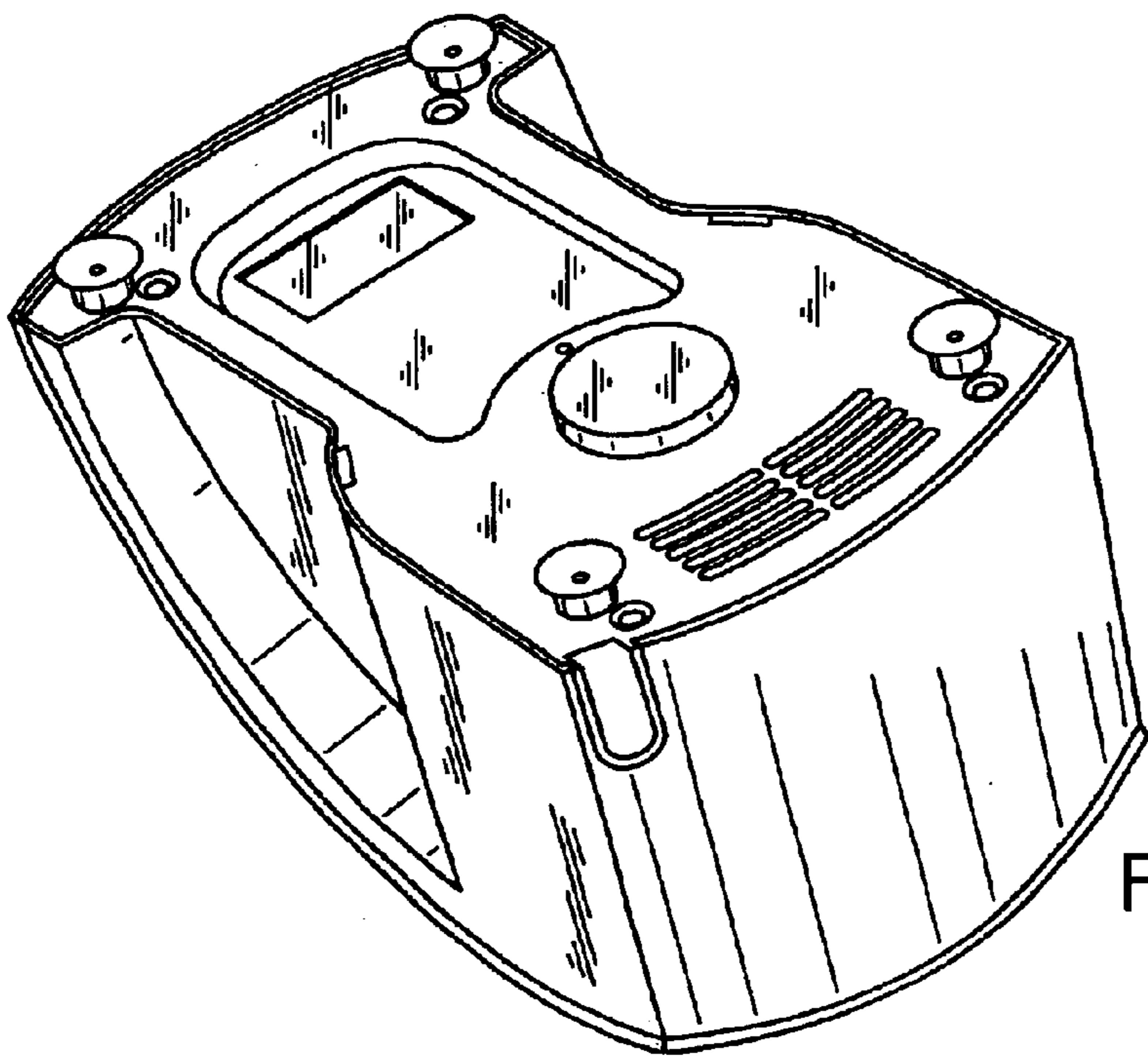

Fig. 2



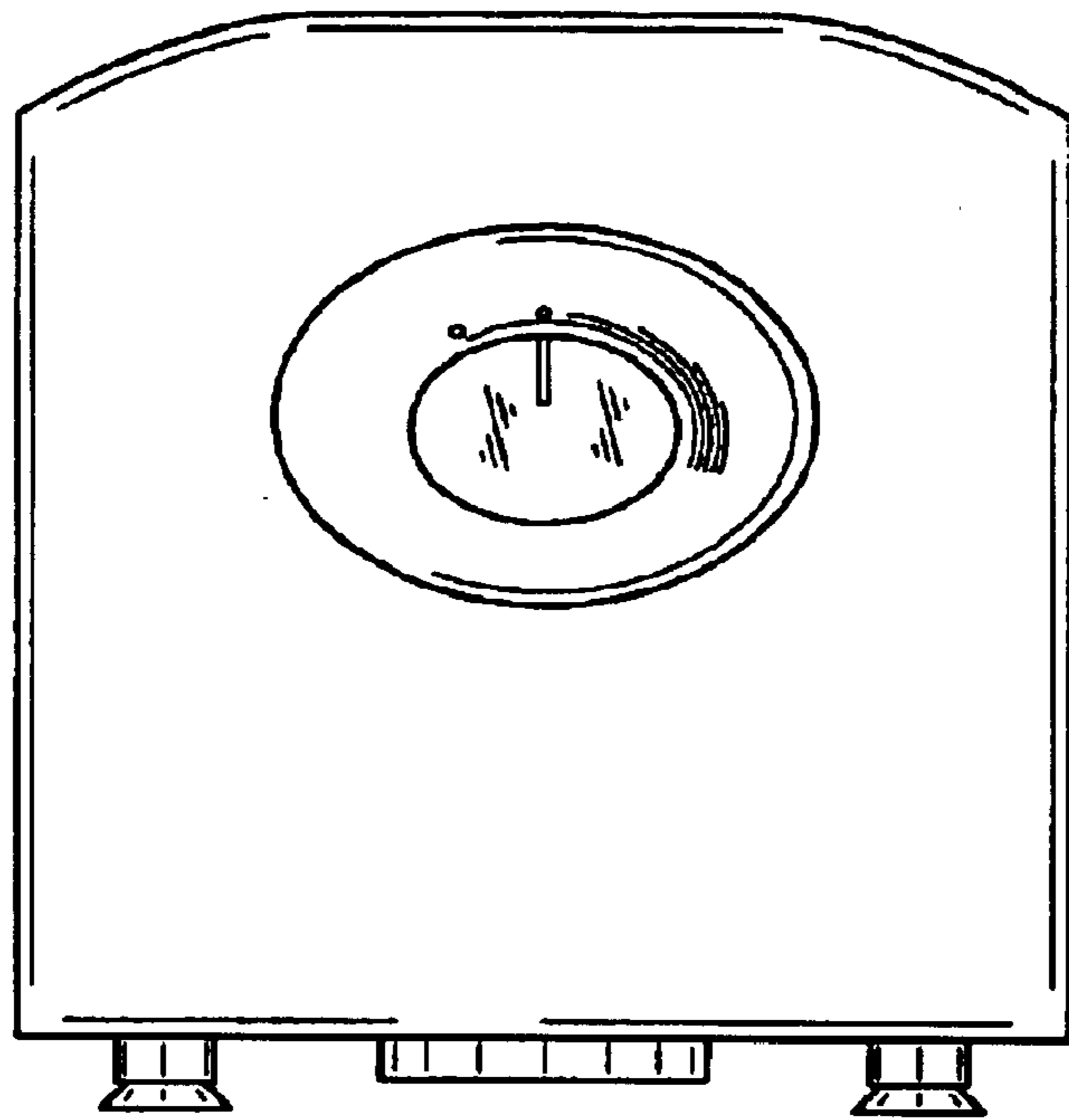

Fig. 3

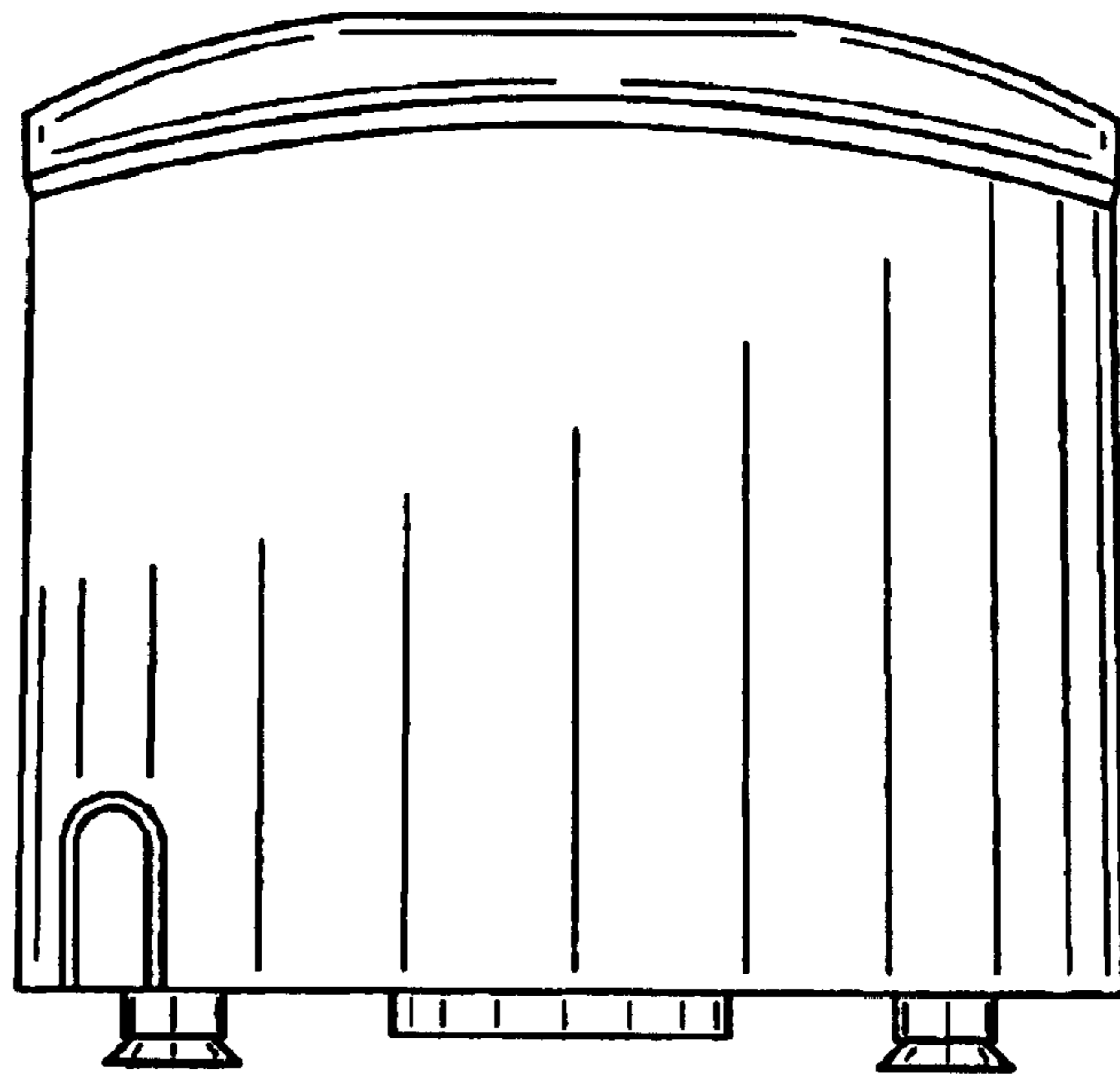

Fig. 4

Fig. 5

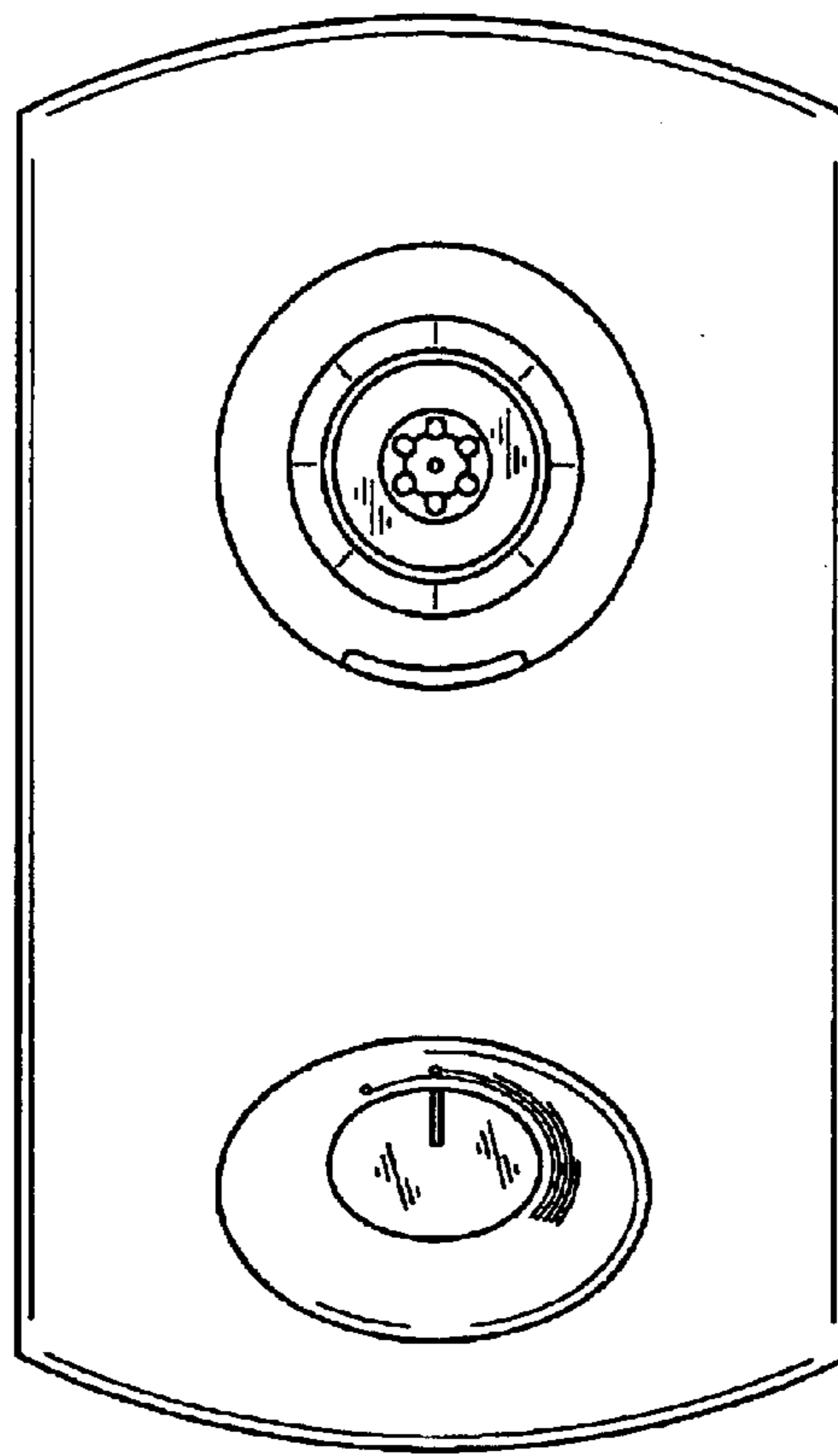
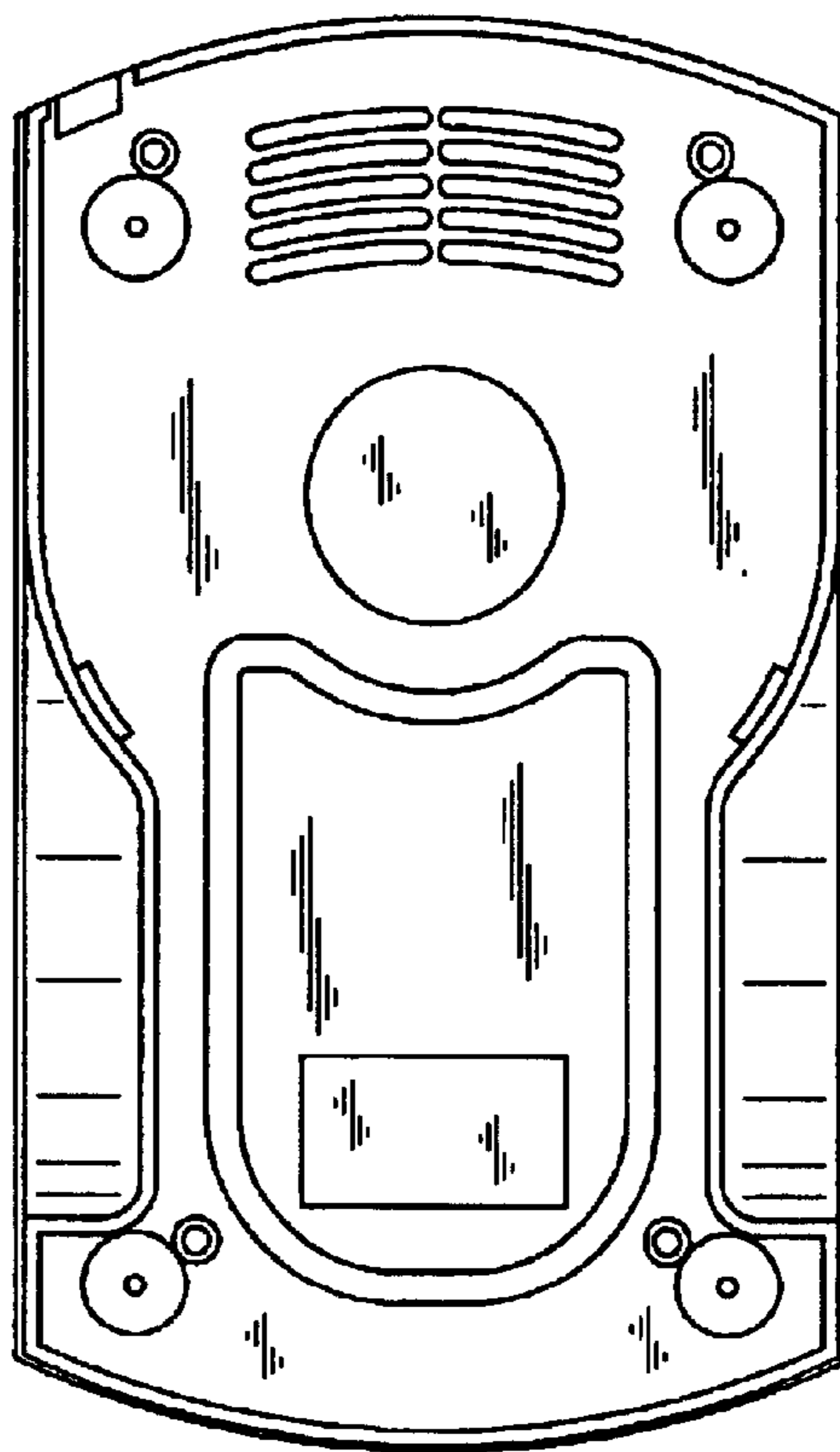

Fig. 6



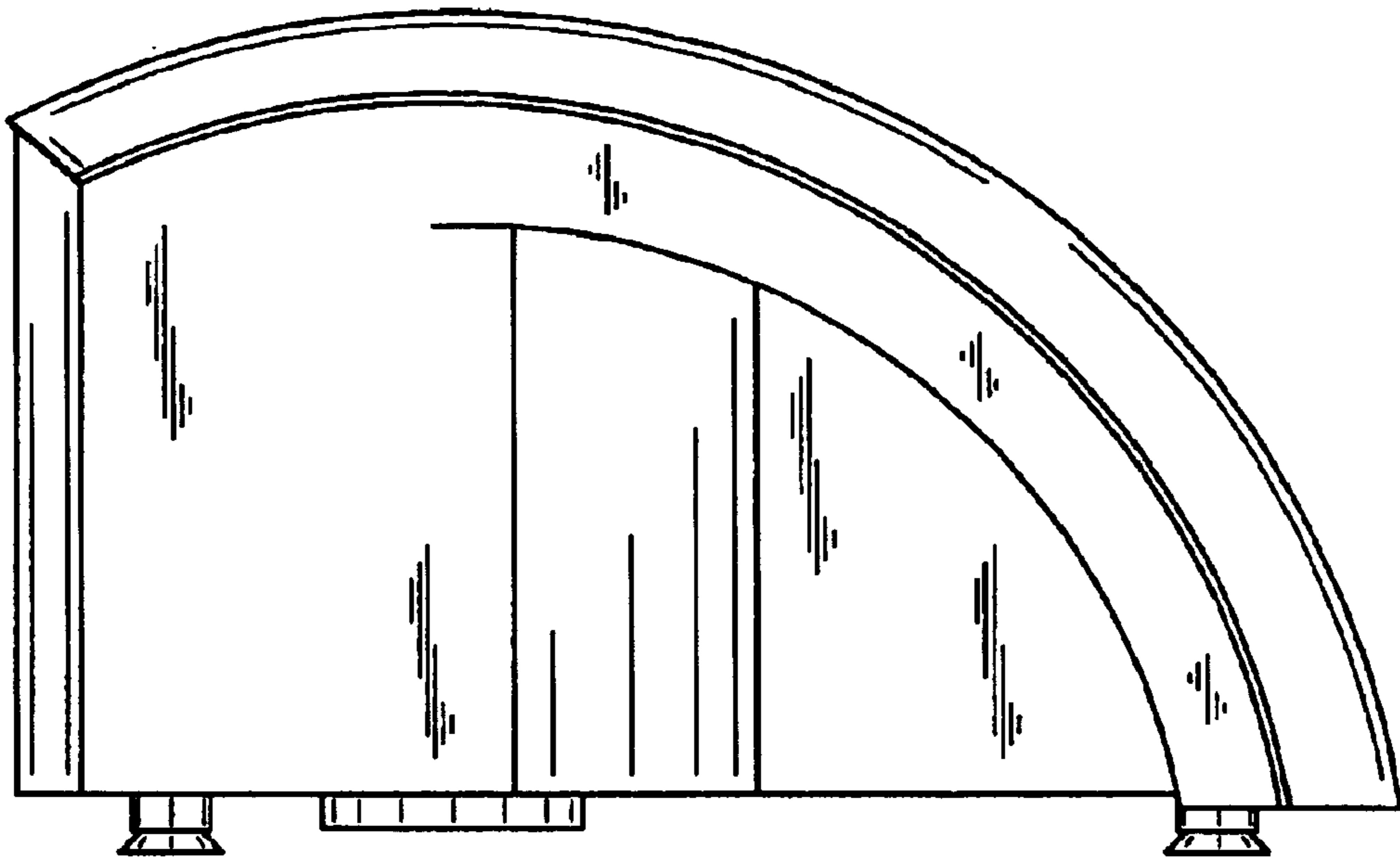

Fig. 7

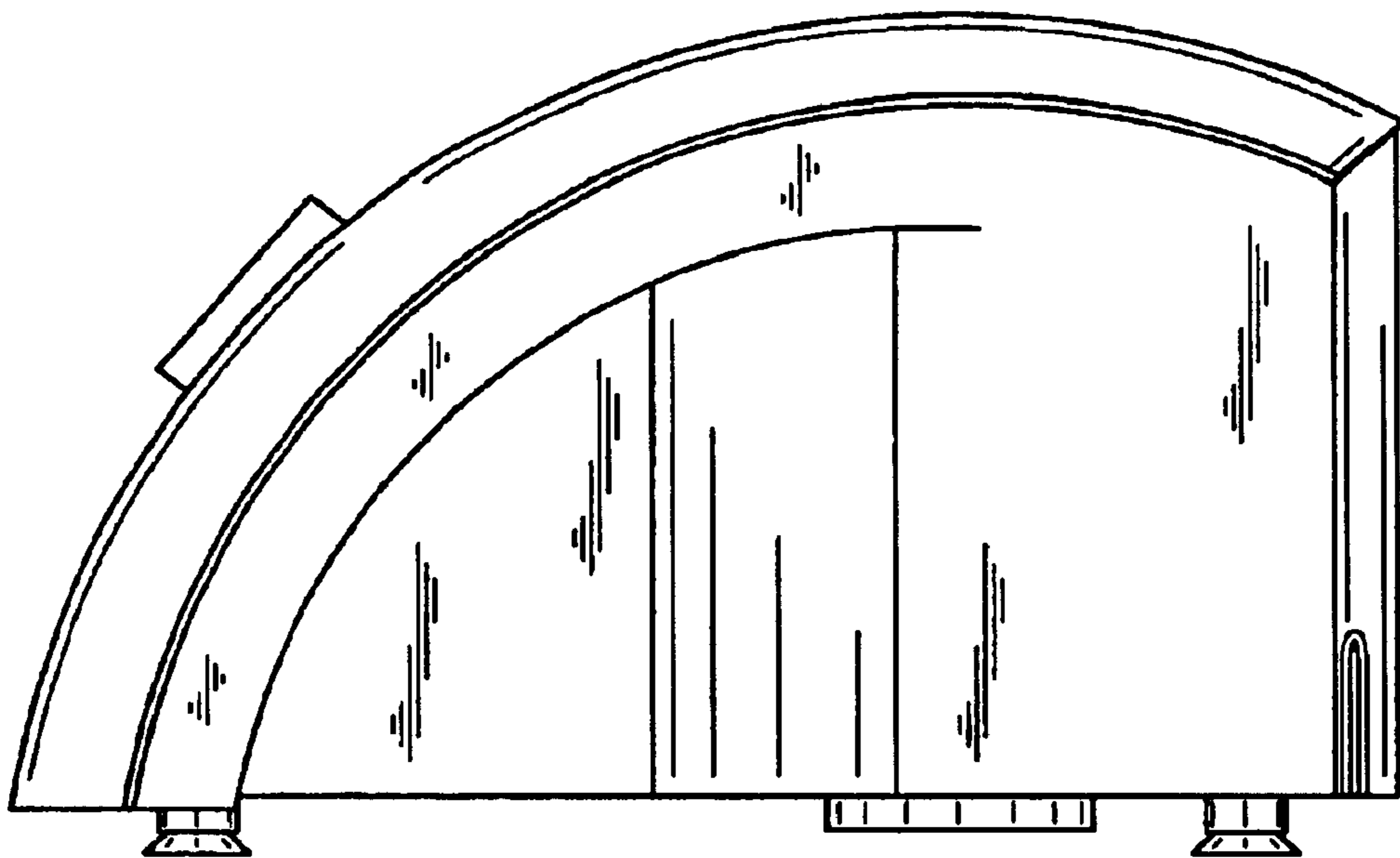

Fig. 8