



US00D489554S

(12) **United States Design Patent**  
**Lemmeyer et al.**

(10) **Patent No.:** **US D489,554 S**

(45) **Date of Patent:** **\*\* May 11, 2004**

(54) **CHAIR BACK**

(75) Inventors: **Gary R. Lemmeyer**, Brecksville, OH (US); **Shelby J. Buell**, Lakewood, OH (US)

(73) Assignee: **Cosco Management, Inc.**, Wilmington, DE (US)

(\*\*) Term: **14 Years**

(21) Appl. No.: **29/179,755**

(22) Filed: **Apr. 15, 2003**

(51) **LOC (7) Cl.** ..... **06-01**

(52) **U.S. Cl.** ..... **D6/500; D6/368**

(58) **Field of Search** ..... D6/334-336, 368, D6/374, 376, 380, 500-502, 379; 297/16.1, 40, 41, 55, 56, 58, 59, 239, 452.29, 440.2, 183.7, 452.1

4,597,604 A	7/1986	Singer	
5,029,942 A	7/1991	Rink	
5,529,380 A	6/1996	Blansett	
5,609,390 A	3/1997	Takafuji	
5,683,142 A	11/1997	Gunderson et al.	
5,820,221 A	10/1998	Greaves et al.	
5,954,391 A	9/1999	Gray	
5,997,096 A	12/1999	Chen	
6,014,783 A	1/2000	Collier et al.	
6,092,866 A	7/2000	Wu	
6,095,611 A	8/2000	Bar et al.	
6,149,240 A	11/2000	Pietrzak	
D436,457 S	* 1/2001	Ambasz	..... D6/368
6,193,307 B1	2/2001	Lin	
D443,429 S	* 6/2001	Mower et al.	..... D6/368
6,257,665 B1	7/2001	Nagamitsu et al.	
D446,661 S	* 8/2001	Ambasz	..... D6/368
6,305,747 B1	* 10/2001	Mei	..... 297/440.2
D465,665 S	* 11/2002	Ritchie et al.	..... D6/368
D465,940 S	* 11/2002	Nien	..... D6/368
6,543,842 B2	4/2003	Haney	
D481,232 S	* 10/2003	Turner et al.	..... D6/500

\* cited by examiner

(56) **References Cited**

**U.S. PATENT DOCUMENTS**

1,263,161 A	4/1918	Travers	
1,396,794 A	11/1921	Travers	
1,760,008 A	5/1930	Schermerhorn	
1,910,760 A	5/1933	Garrow	
1,919,746 A	7/1933	Rastetter	
1,948,216 A	2/1934	Gillette	
2,016,385 A	10/1935	Molling et al.	
2,509,107 A	5/1950	O'Connor	
2,524,624 A	10/1950	Cramer	
2,662,588 A	12/1953	Clark	
2,703,601 A	3/1955	Wood	
2,991,123 A	* 7/1961	Hamilton	..... 297/55
3,001,816 A	* 9/1961	Clarín	..... 297/56
D214,267 S	* 5/1969	Moore et al.	..... D6/368
D217,344 S	4/1970	Lindfors	
3,603,640 A	9/1971	Doerner	
3,695,687 A	* 10/1972	Uyeda	..... 297/56
3,989,297 A	11/1976	Kerstholt	
4,135,836 A	1/1979	Rensland et al.	
4,157,203 A	6/1979	Ambasz	
4,316,632 A	2/1982	Brauning	
4,400,032 A	8/1983	dePolo	
4,588,228 A	5/1986	Nemoto	

*Primary Examiner*—Doris V. Coles

*Assistant Examiner*—Mimosa De

(74) *Attorney, Agent, or Firm*—Barnes & Thornburg

(57) **CLAIM**

The ornamental design for a chair back, as shown and described.

**DESCRIPTION**

FIG. 1 is a perspective view of a chair back in accordance with our new design, with portions of a chair forming the environment of the chair back and being illustrated in broken lines, which broken lines are for illustrative purposes only and form no part of the claimed design;

FIG. 2 is a front elevational view of the chair back shown in FIG. 1;

FIG. 3 is a right-side elevational view thereof, the right and left sides of the chair back being a mirror image;

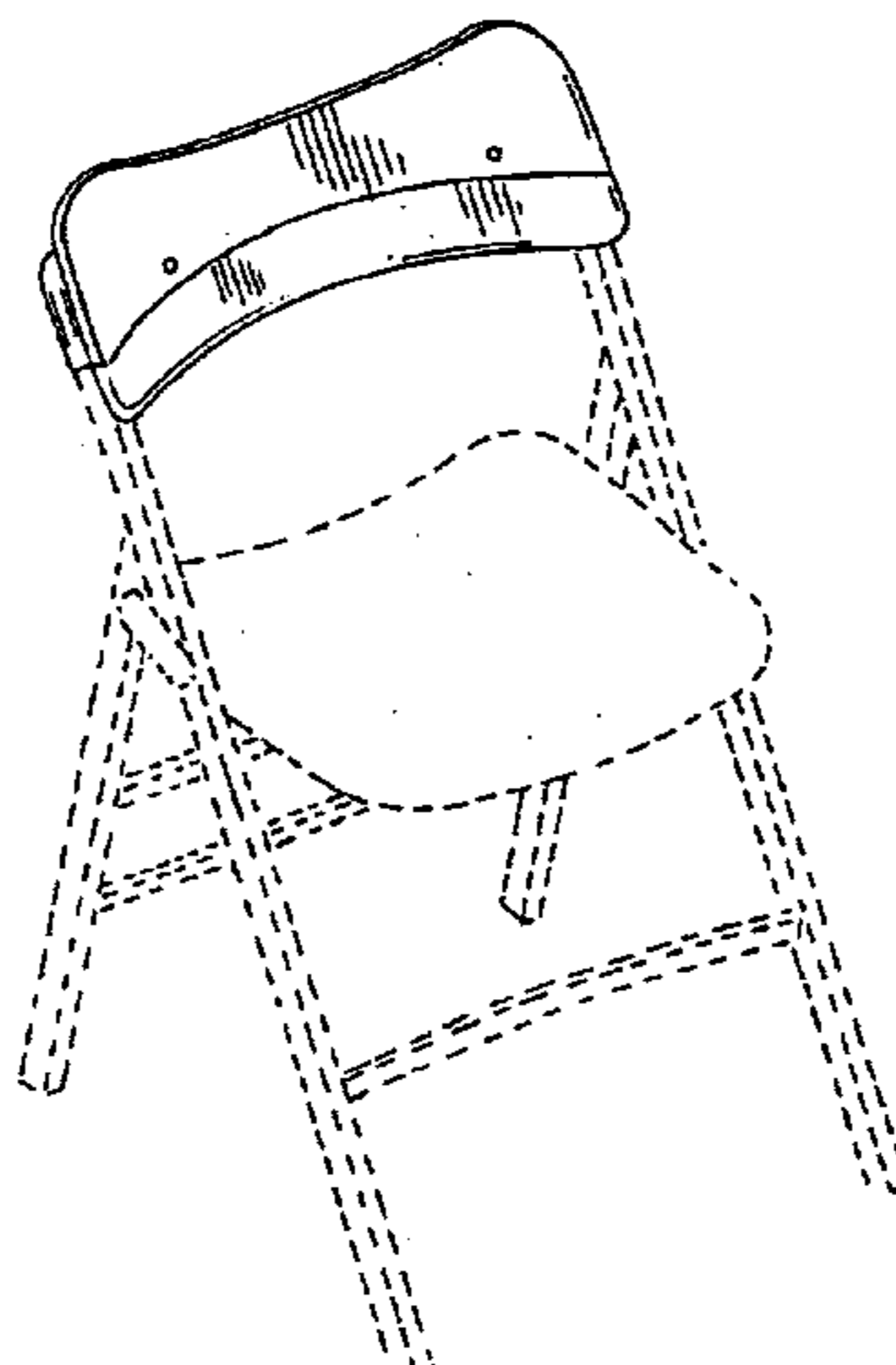
FIG. 4 is a front view of FIG. 1;

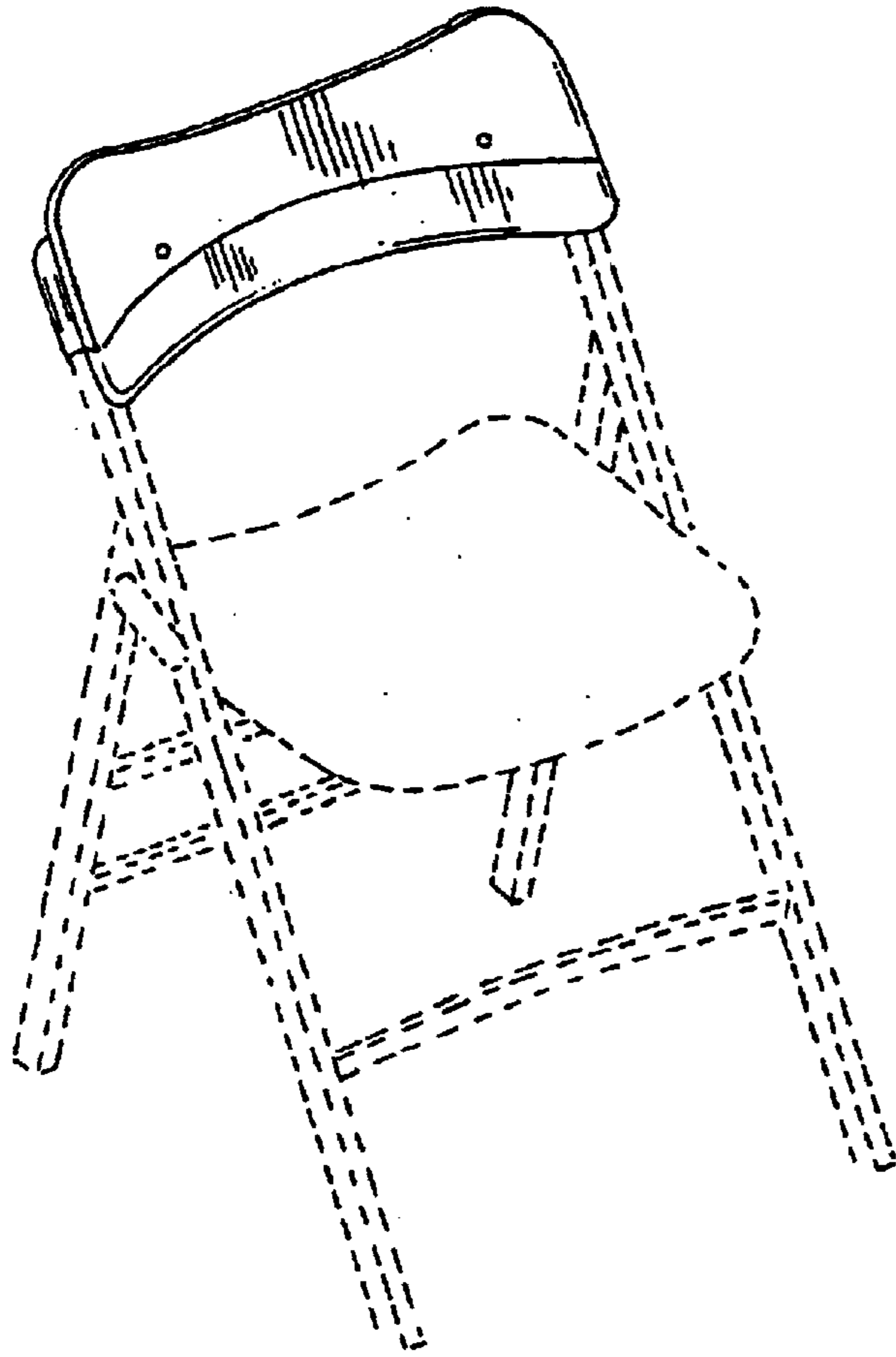
FIG. 5 is a top view;

FIG. 6 is a rear view; and,

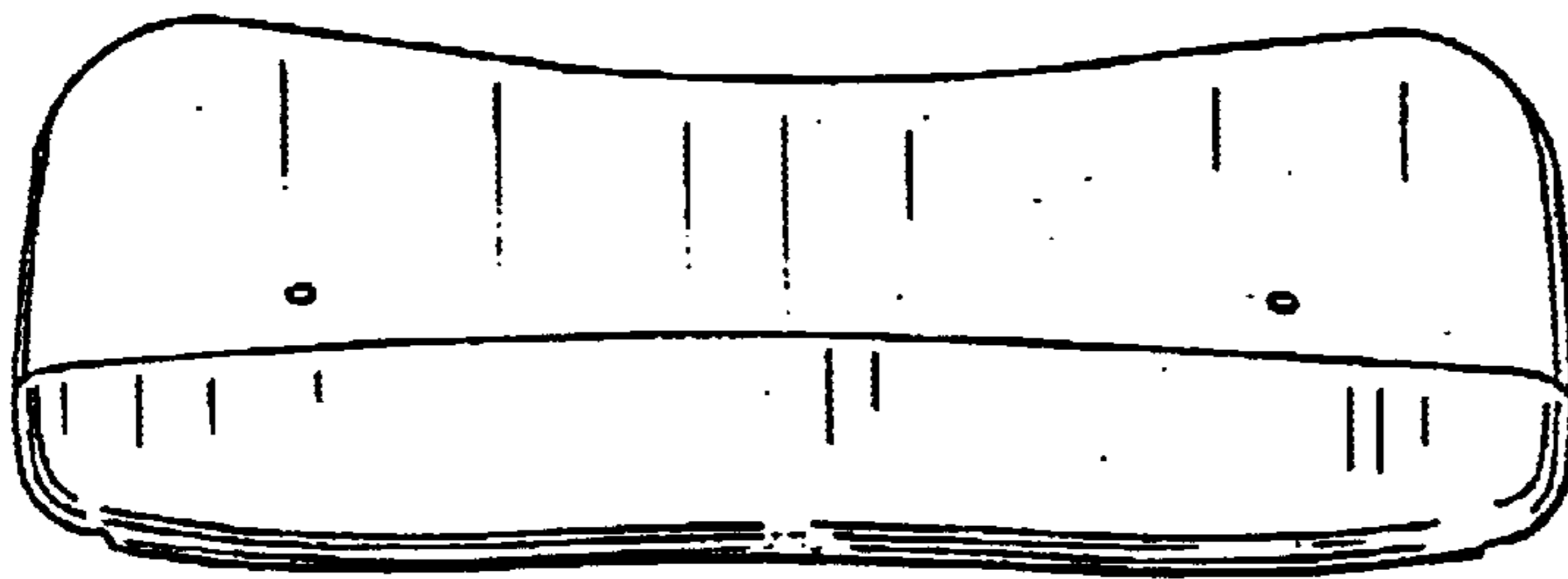
FIG. 7 is a bottom view.

**1 Claim, 2 Drawing Sheets**

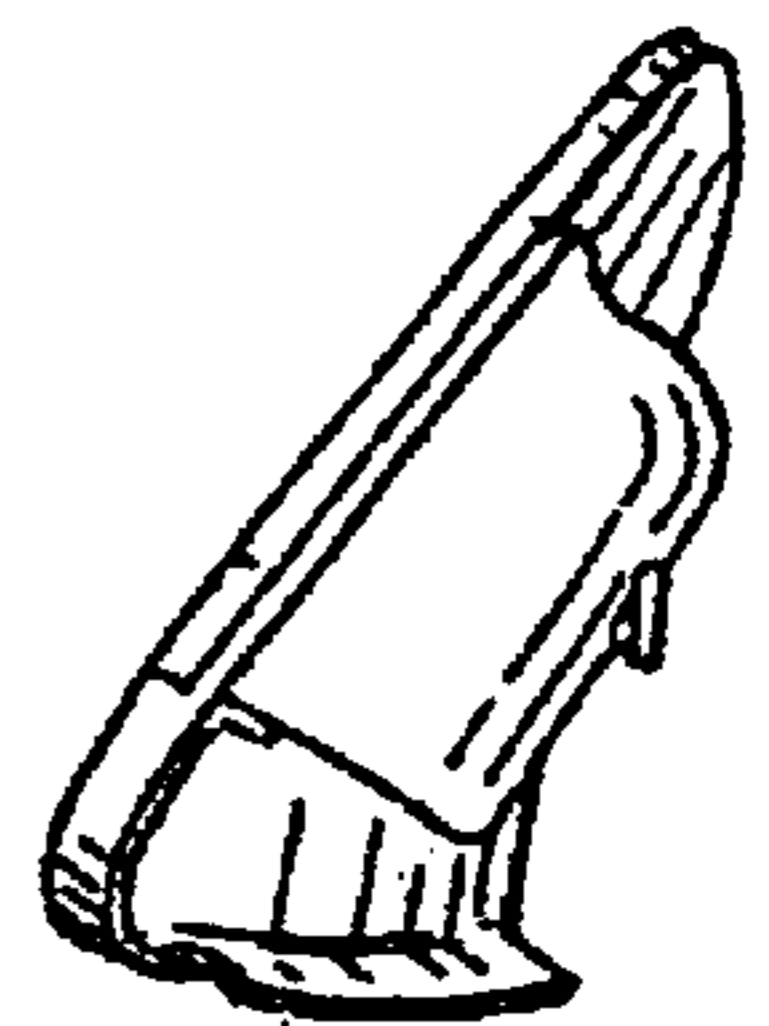




*FIG. 1*



*FIG. 2*



*FIG. 3*

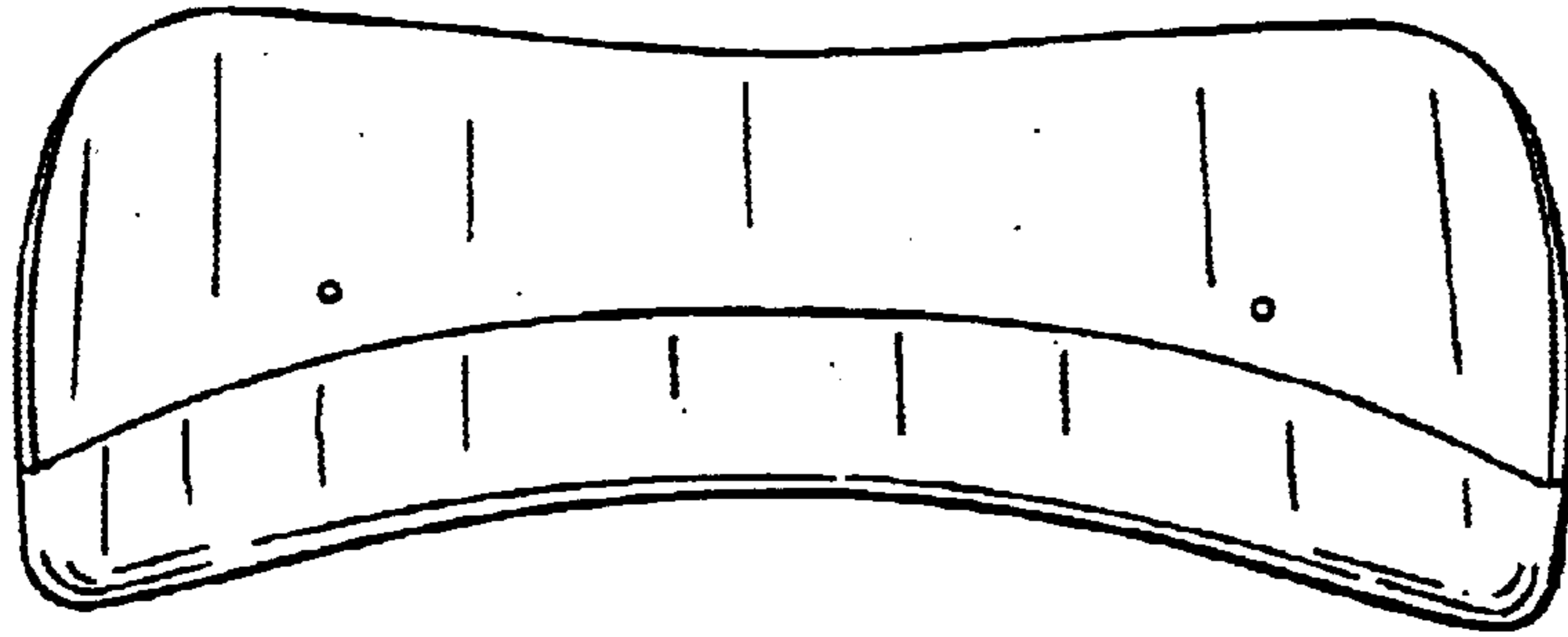


FIG. 4

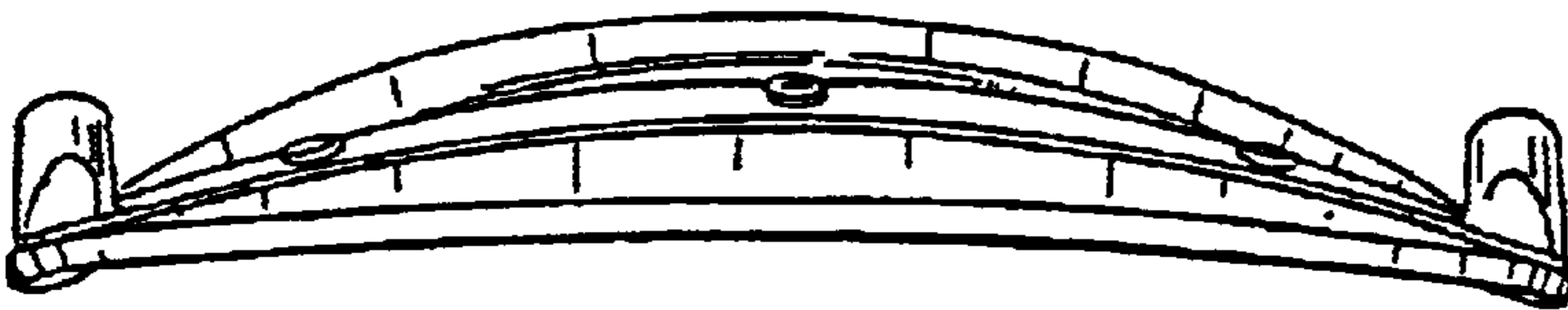


FIG. 5

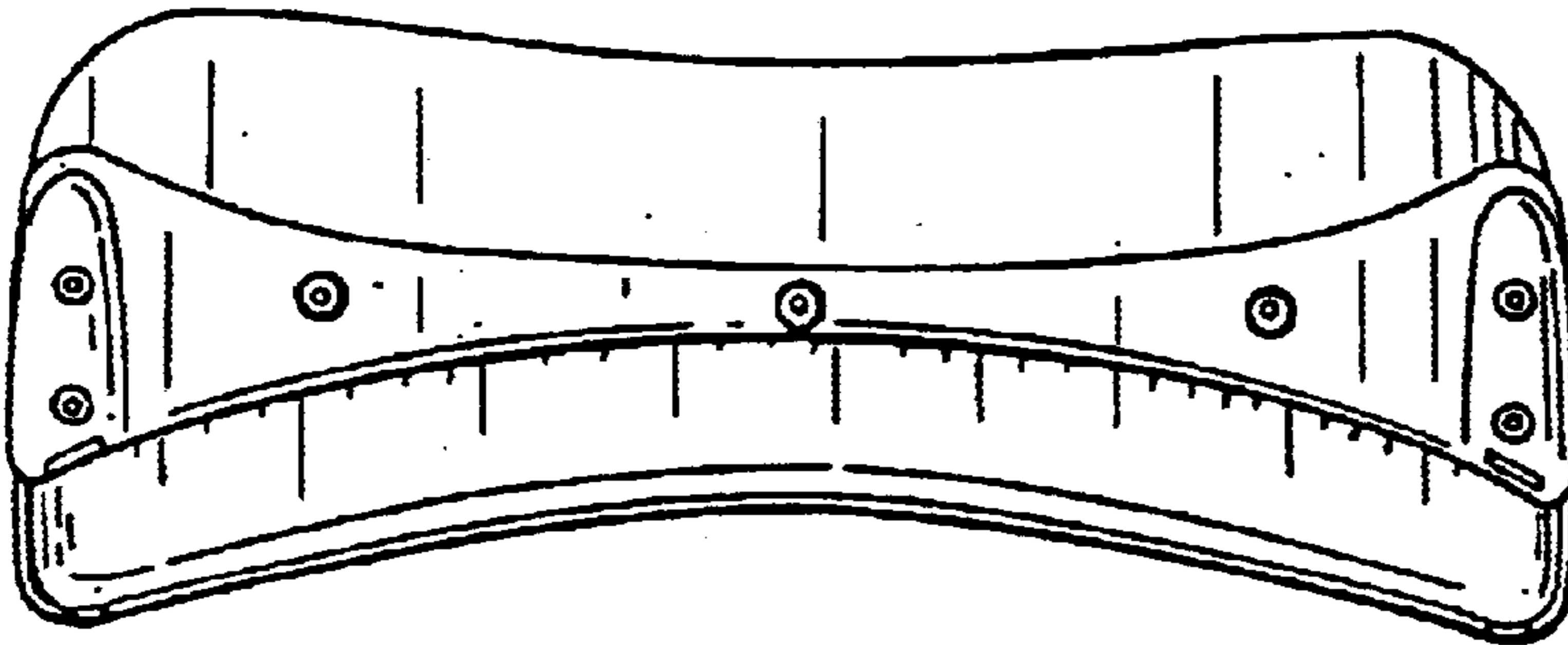


FIG. 6



FIG. 7