



US00D489499S

(12) **United States Design Patent**
Buzzi

(10) **Patent No.:** **US D489,499 S**

(45) **Date of Patent:** **** May 4, 2004**

(54) **STEAM CLEANER**

(75) Inventor: **Bruno Buzzi**, Turin (IT)

(73) Assignee: **Buzzi S.R.L.**, Turin (IT)

(**) Term: **14 Years**

(21) Appl. No.: **29/176,471**

(22) Filed: **Feb. 24, 2003**

(51) **LOC (7) Cl.** **15-05**

(52) **U.S. Cl.** **D32/17**

(58) **Field of Search** D32/17-18, 21,
D32/23, 24, 31-34; 15/321, 347, 344, 329,
353, 327.1-327.4, 327.6, 327.7, 323, 320,
412; 96/225-226; 68/222; 392/404

(56) **References Cited**

U.S. PATENT DOCUMENTS

D338,989 S * 8/1993 Ambrosiano D32/15
D445,973 S * 7/2001 Chen D32/21

D452,594 S * 12/2001 Rosa D32/21
D463,889 S * 10/2002 Buzzi D32/17
D471,682 S * 3/2003 Chen D32/21
D477,443 S * 7/2003 Kondo et al. D32/21

* cited by examiner

Primary Examiner—Ruth McInroy

(74) *Attorney, Agent, or Firm*—Sughrue Mion, PLLC

(57) **CLAIM**

The ornamental design for a steam cleaner, as shown.

DESCRIPTION

FIG. 1 is a right side elevational view of a steam cleaner showing my new design;
FIG. 2 is a top plan view thereof;
FIG. 3 is a left side elevational view thereof;
FIG. 4 is a bottom plan view thereof;
FIG. 5 is a rear elevational view thereof; and,
FIG. 6 is a front elevational view thereof.

1 Claim, 3 Drawing Sheets

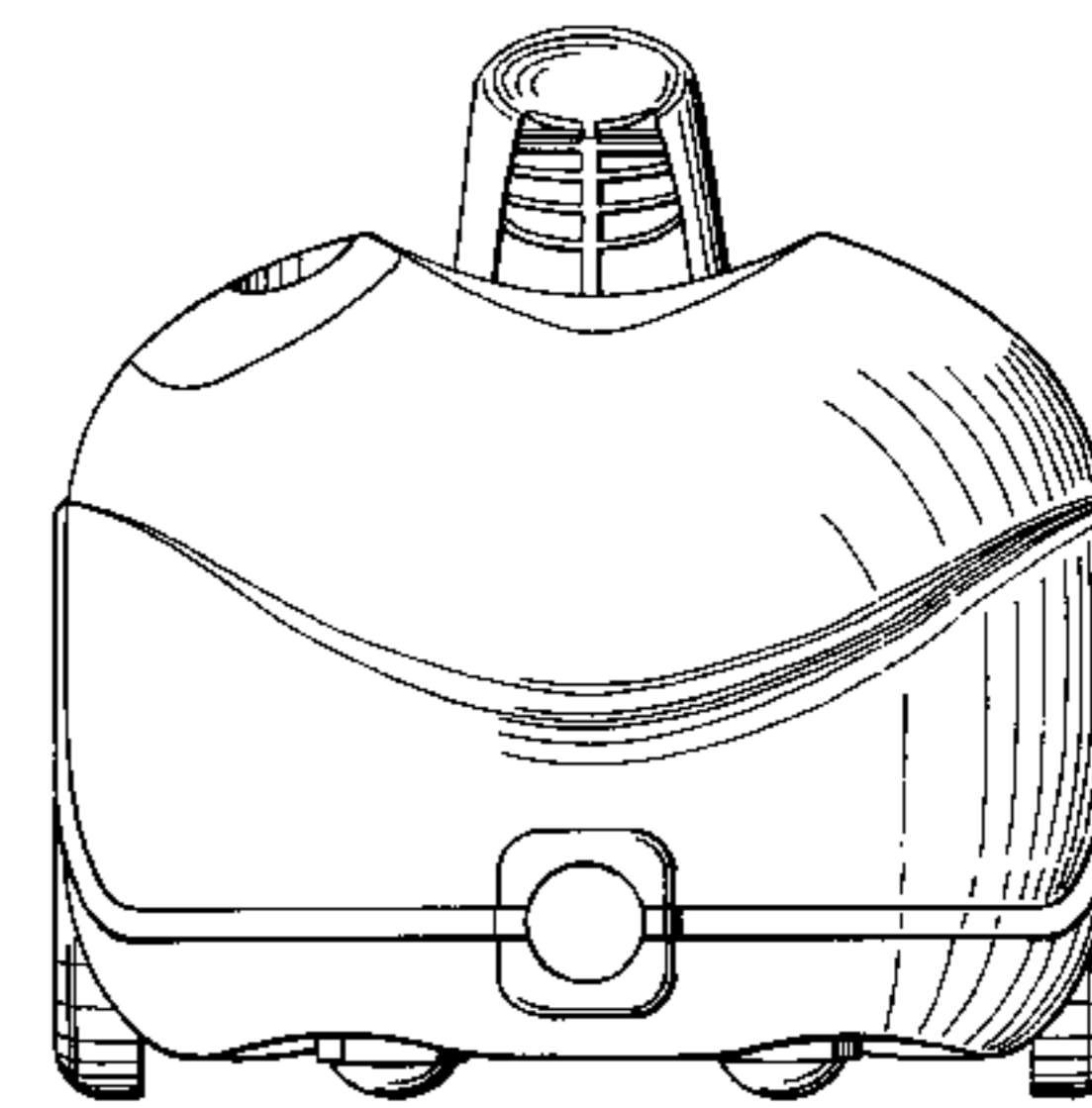
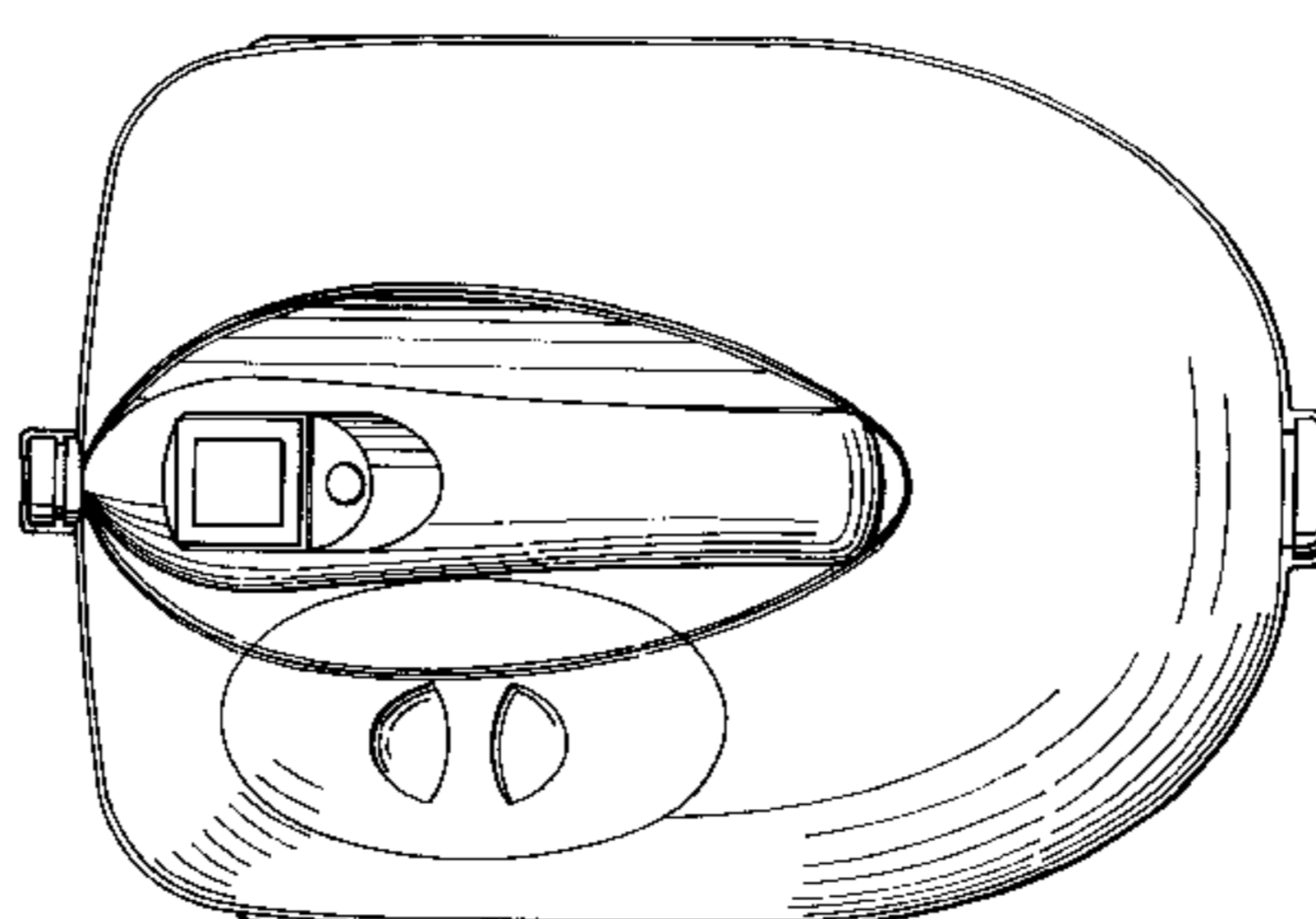
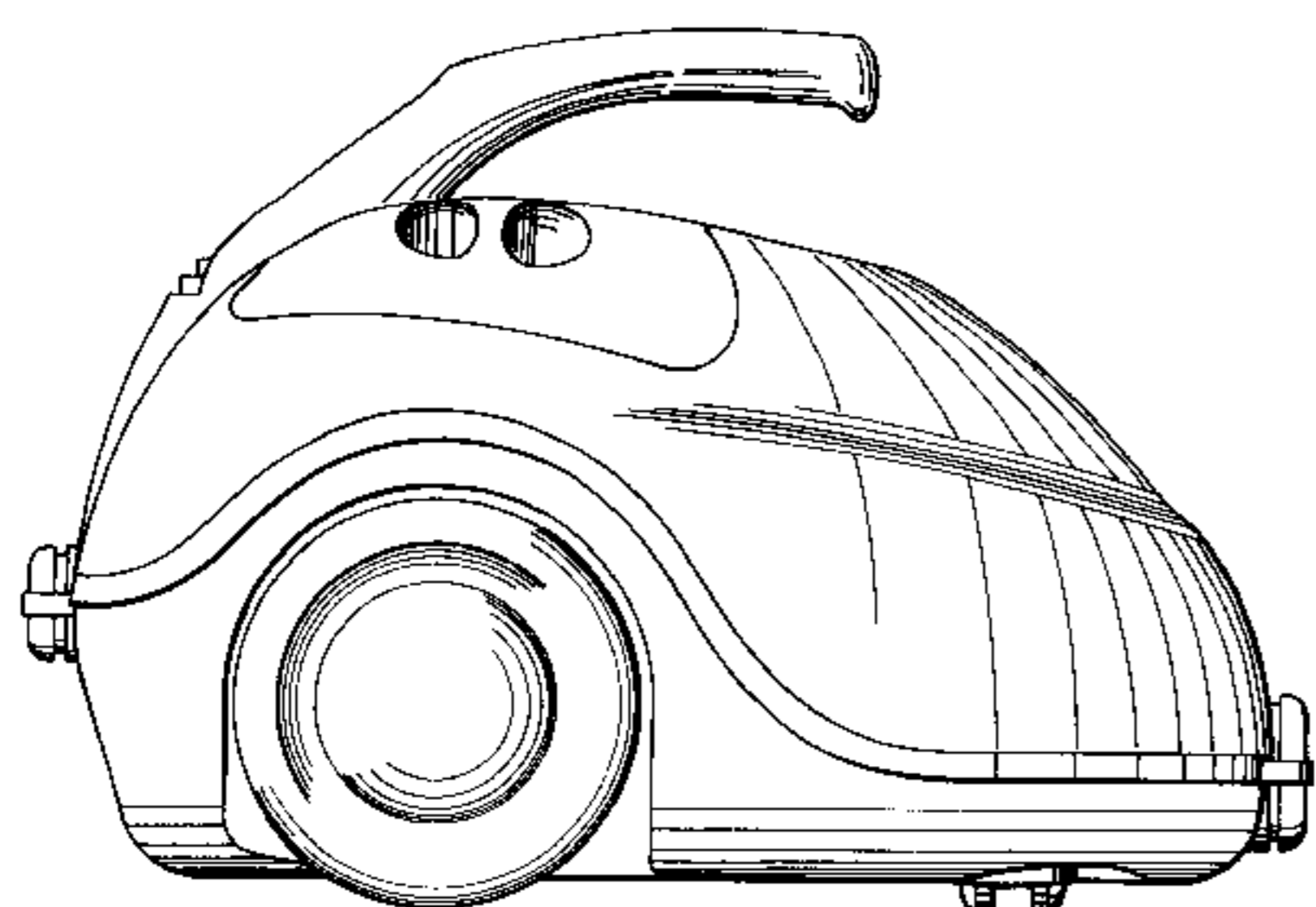

Fig. 1

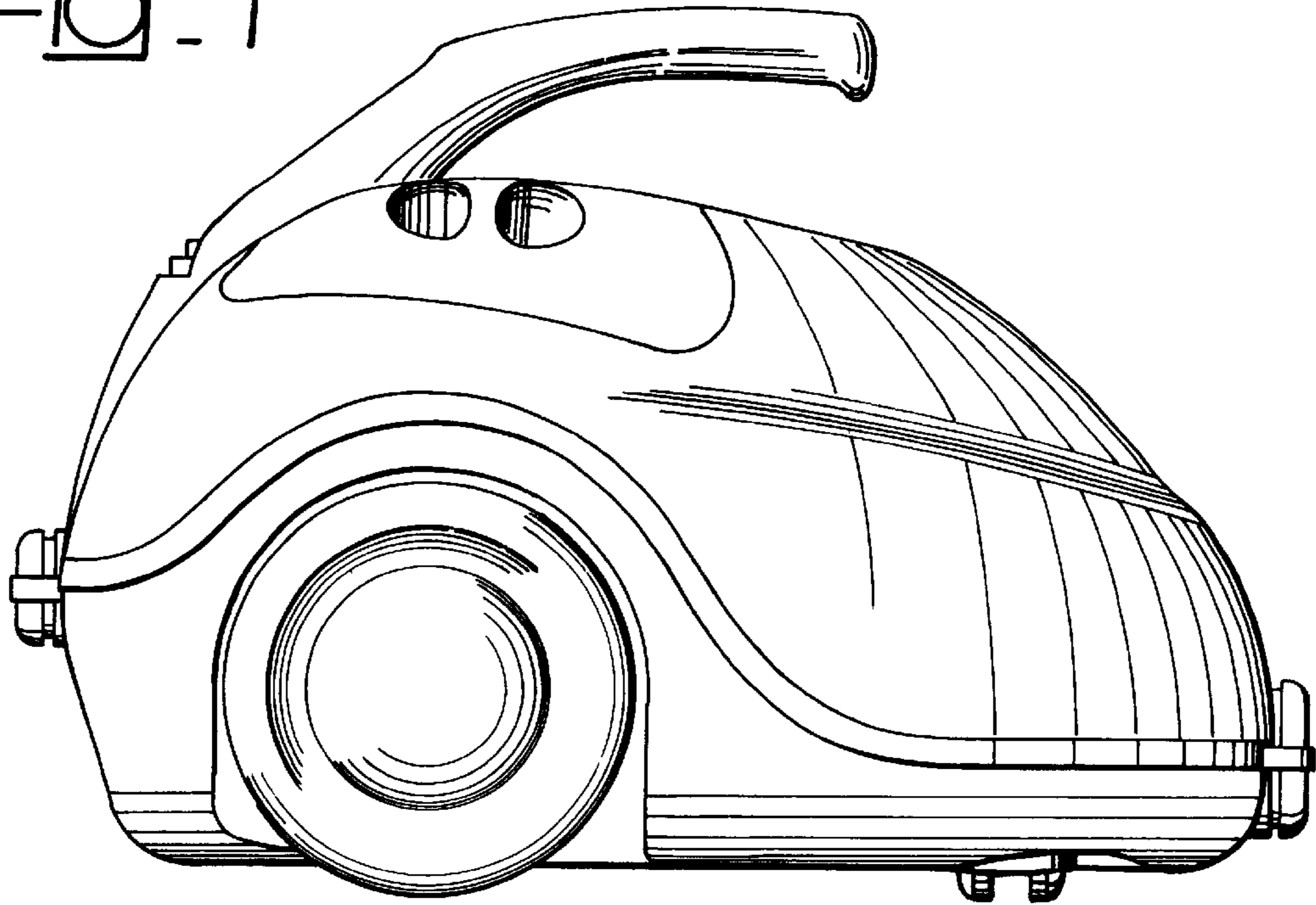

Fig. 2

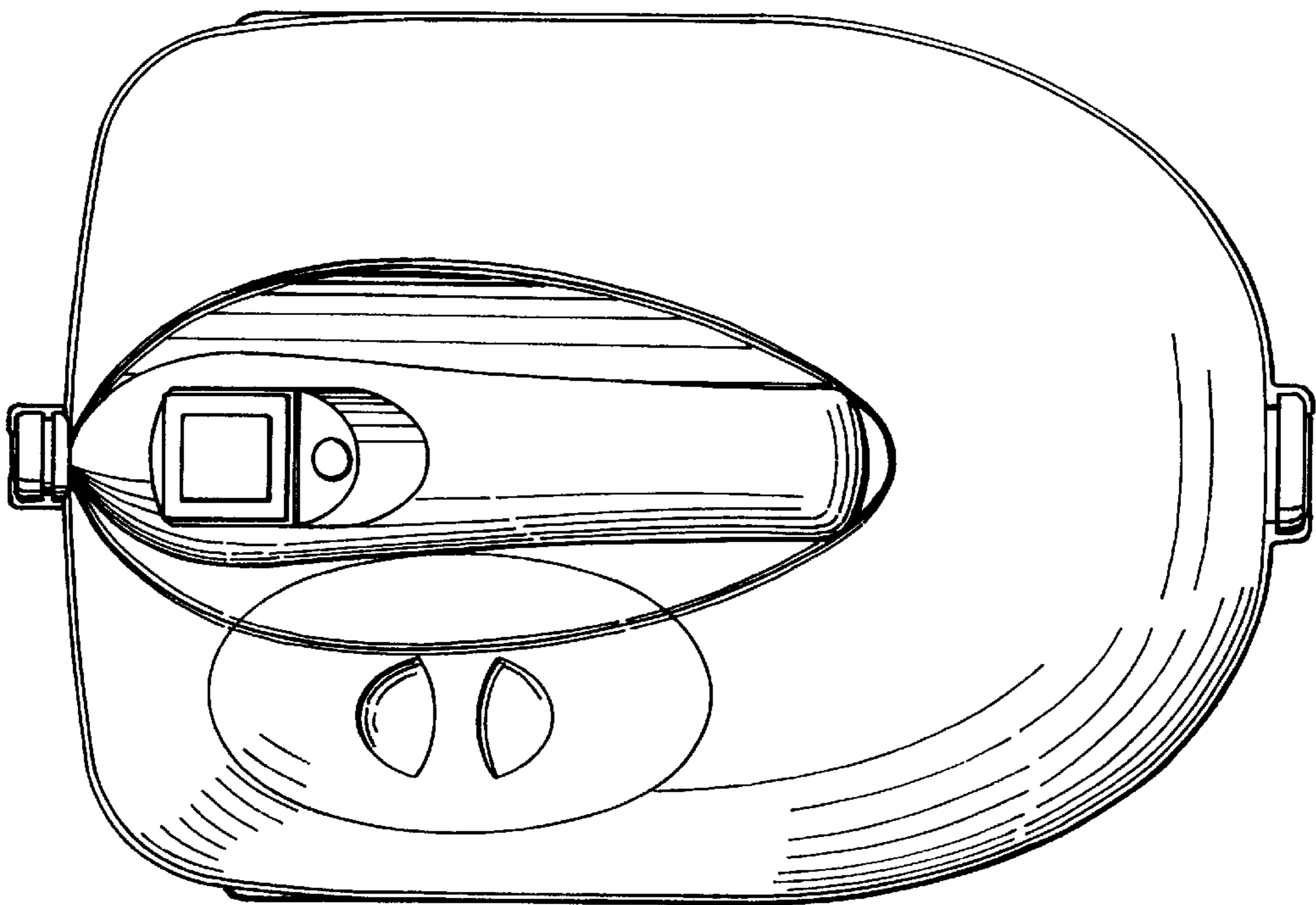

Fig. 3

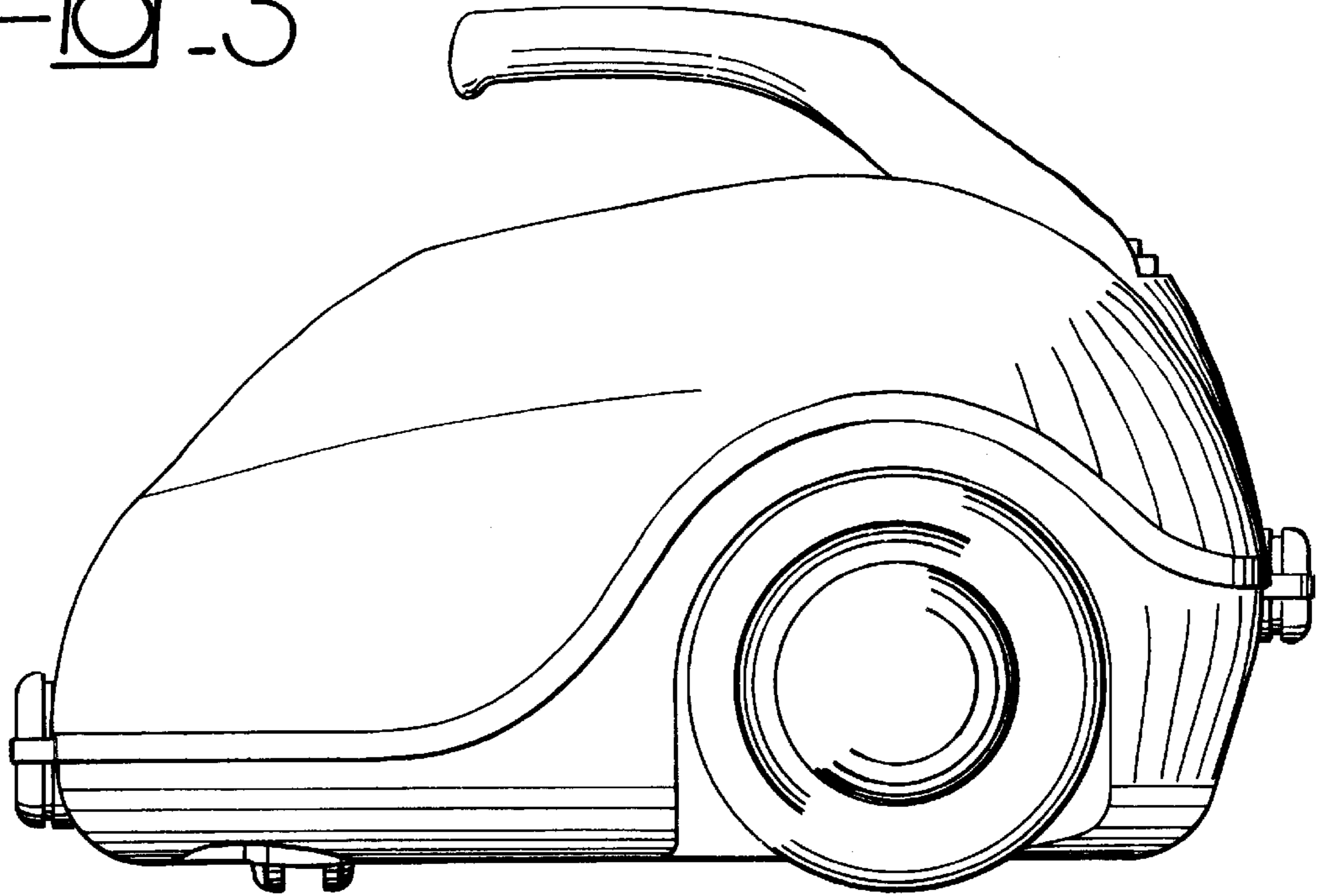

Fig. 4

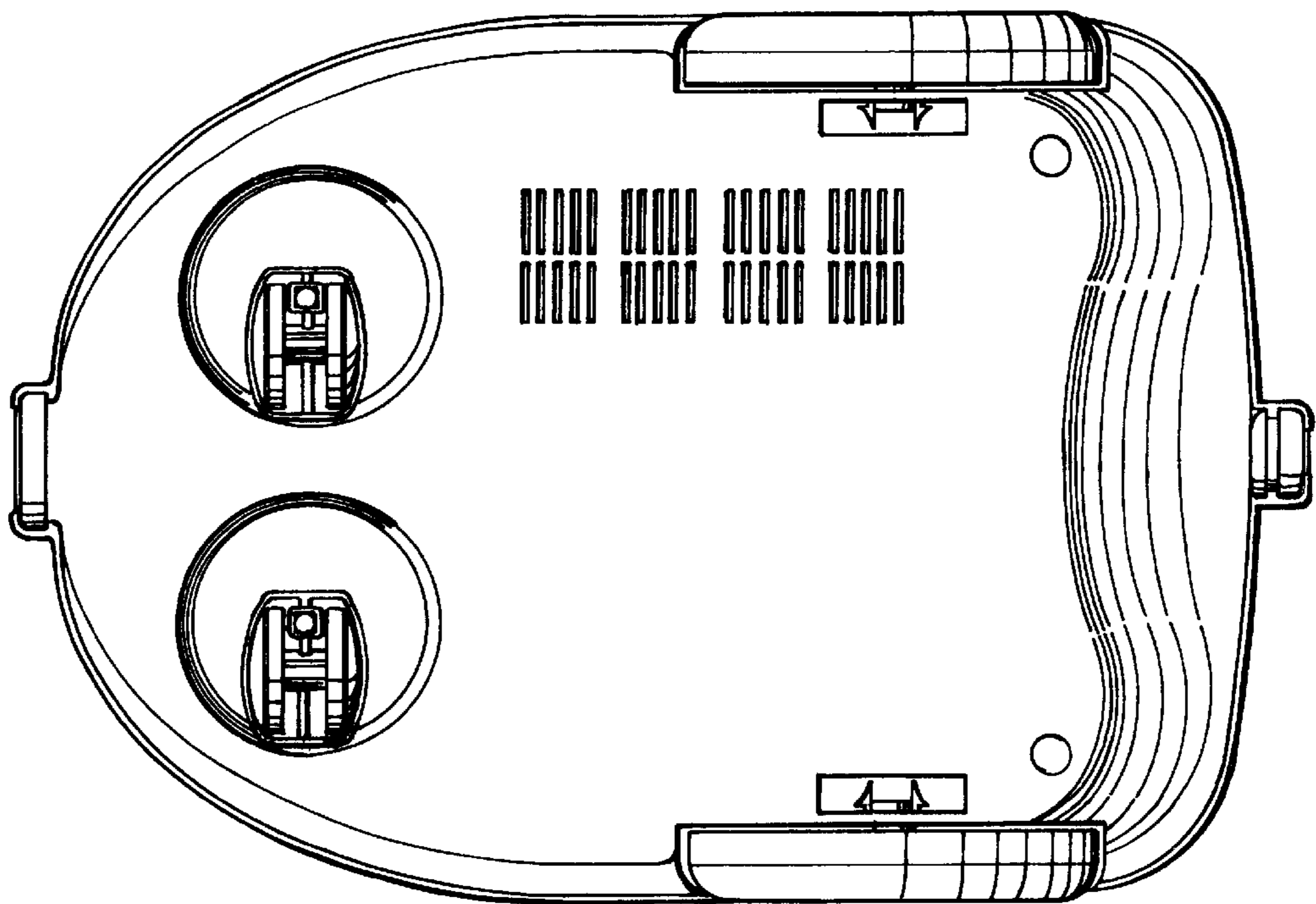

Fig-5

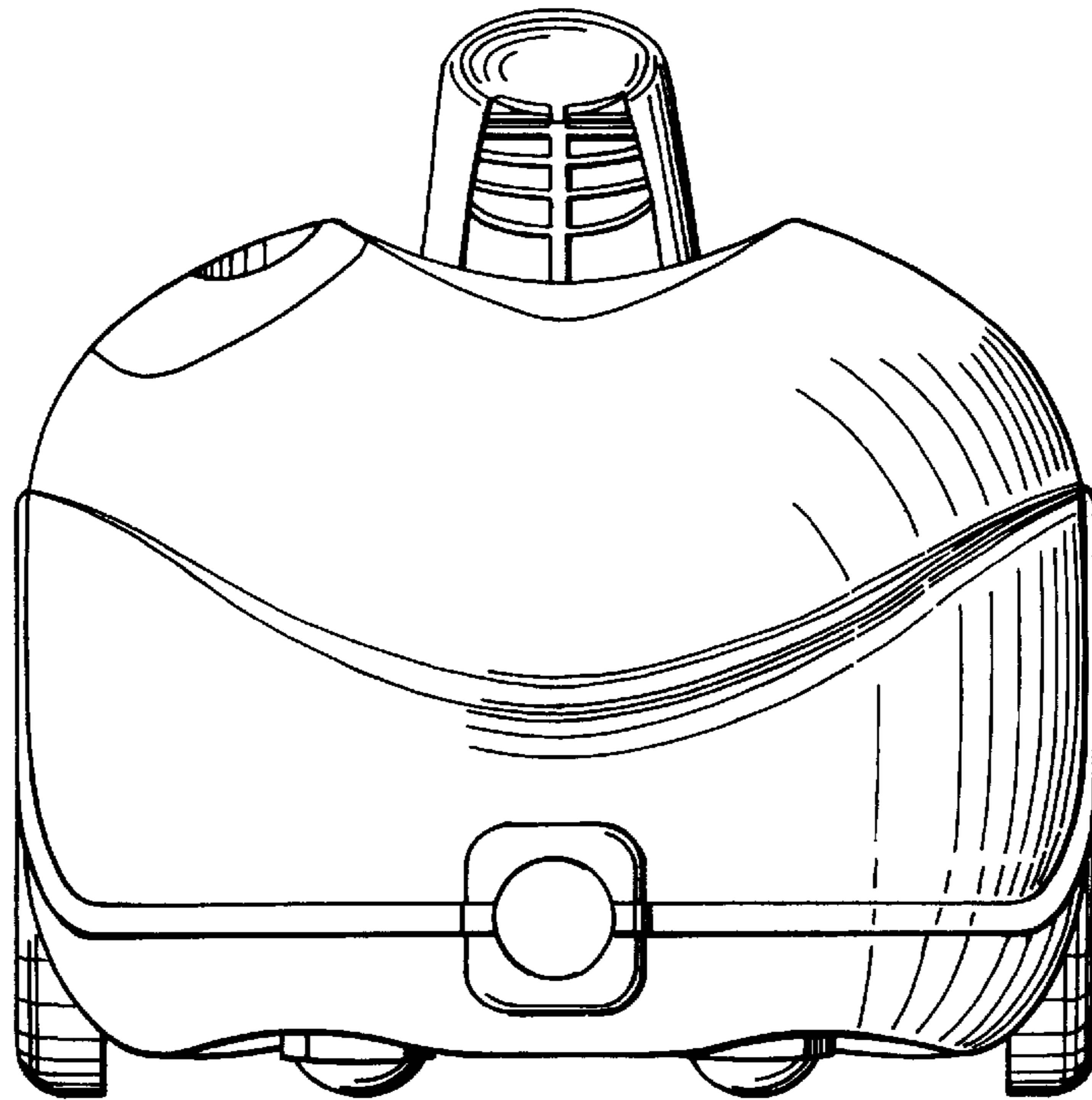

Fig-6

