



US00D489457S

(12) **United States Design Patent**
Cohn et al.

(10) **Patent No.:** **US D489,457 S**

(45) **Date of Patent:** **** May 4, 2004**

(54) **HANDLE**

(75) **Inventors:** **Simon Cohn**, N. Arlington, NJ (US);
Glade Harold Howell, Sandy, UT
(US); **John R. Montgomery**, Stanford,
KY (US); **Paul Di Cesare**, Easton, CT
(US); **Bart D. Peterson**, W. Jordan, UT
(US)

(73) **Assignee:** **Becton Dickinson and Company**,
Franklin Lakes, NJ (US)

(**) **Term:** **14 Years**

4,805,304 A	2/1989	Knoop	30/162
4,823,457 A	4/1989	Prochaska	29/509
4,844,070 A	7/1989	Dee	128/305
4,884,569 A	12/1989	Fedorov et al.	128/305
4,903,390 A	2/1990	Vidal et al.	29/239
4,949,458 A	8/1990	Davis et al.	30/162
5,055,106 A	10/1991	Lundgren	606/167
5,071,418 A	12/1991	Rosenbaum	606/42
5,071,426 A	12/1991	Dolgin et al.	606/167
D327,125 S	6/1992	Iten	D24/30
5,141,517 A	8/1992	Shutt	606/167
D330,082 S	10/1992	Schutte et al.	D24/147
5,197,953 A	3/1993	Colonna	604/110
5,201,748 A	4/1993	Newman et al.	606/167

(List continued on next page.)

(21) **Appl. No.:** **29/173,389**

(22) **Filed:** **Dec. 27, 2002**

(51) **LOC (7) Cl.** **24-02**

(52) **U.S. Cl.** **D24/147**

(58) **Field of Search** D24/147, 146,
D24/133; 30/337, 329, 157, 332, 339, 340;
606/167

FOREIGN PATENT DOCUMENTS

DE	3722899 A1	1/1989
EP	583 992 A1	2/1994
EP	0 727 186 A2	8/1996
EP	793 943 A1	9/1997
WO	WO 97/34535	9/1997

Primary Examiner—Ian Simmons

(74) *Attorney, Agent, or Firm*—James J. Murtha

(56) **References Cited**

U.S. PATENT DOCUMENTS

2,735,176 A	2/1956	Costin	30/162
2,885,780 A	5/1959	Campbell	30/164.9
2,968,489 A	1/1961	Doniger	279/48
3,025,598 A	3/1962	Nissen	30/162
3,657,812 A	4/1972	Lee	30/162
3,793,726 A	2/1974	Schrank	30/151
3,905,101 A	9/1975	Shepherd	30/162
3,906,626 A	9/1975	Riuli	30/162
4,091,537 A	5/1978	Stevenson, Jr.	30/286
4,318,473 A	3/1982	Sandel	206/370
4,375,218 A	3/1983	DiGeronimo	128/313.17
4,414,974 A	11/1983	Dotson et al.	128/305
4,491,132 A	1/1985	Aikins	128/305
4,523,379 A	6/1985	Osterhout et al.	30/151
4,576,164 A	3/1986	Richeson	128/305
4,660,287 A	4/1987	Decker	30/339
4,663,846 A	5/1987	Takayama	30/162
4,735,202 A	4/1988	Williams	128/305
4,798,000 A	* 1/1989	Bedner et al.	606/167

(57) **CLAIM**

The ornamental design for a handle, as shown and described.

DESCRIPTION

FIG. 1 is a perspective view of the handle from the left proximal end of the handle;
FIG. 2 is a top view of the handle of FIG. 1;
FIG. 3 is a left elevation view of the handle of the handle of FIG. 1;
FIG. 4 is a right elevation view of the handle of FIG. 1;
FIG. 5 is a bottom elevation view of the handle of FIG. 1;
FIG. 6 is a front elevation view of the handle of FIG. 1; and,
FIG. 7 is a rear elevation view of the handle of FIG. 1.
The broken line showing in the FIGS. 1, 3 and 4 are for illustrative purposes only and forms no part of the claimed design.

1 Claim, 4 Drawing Sheets

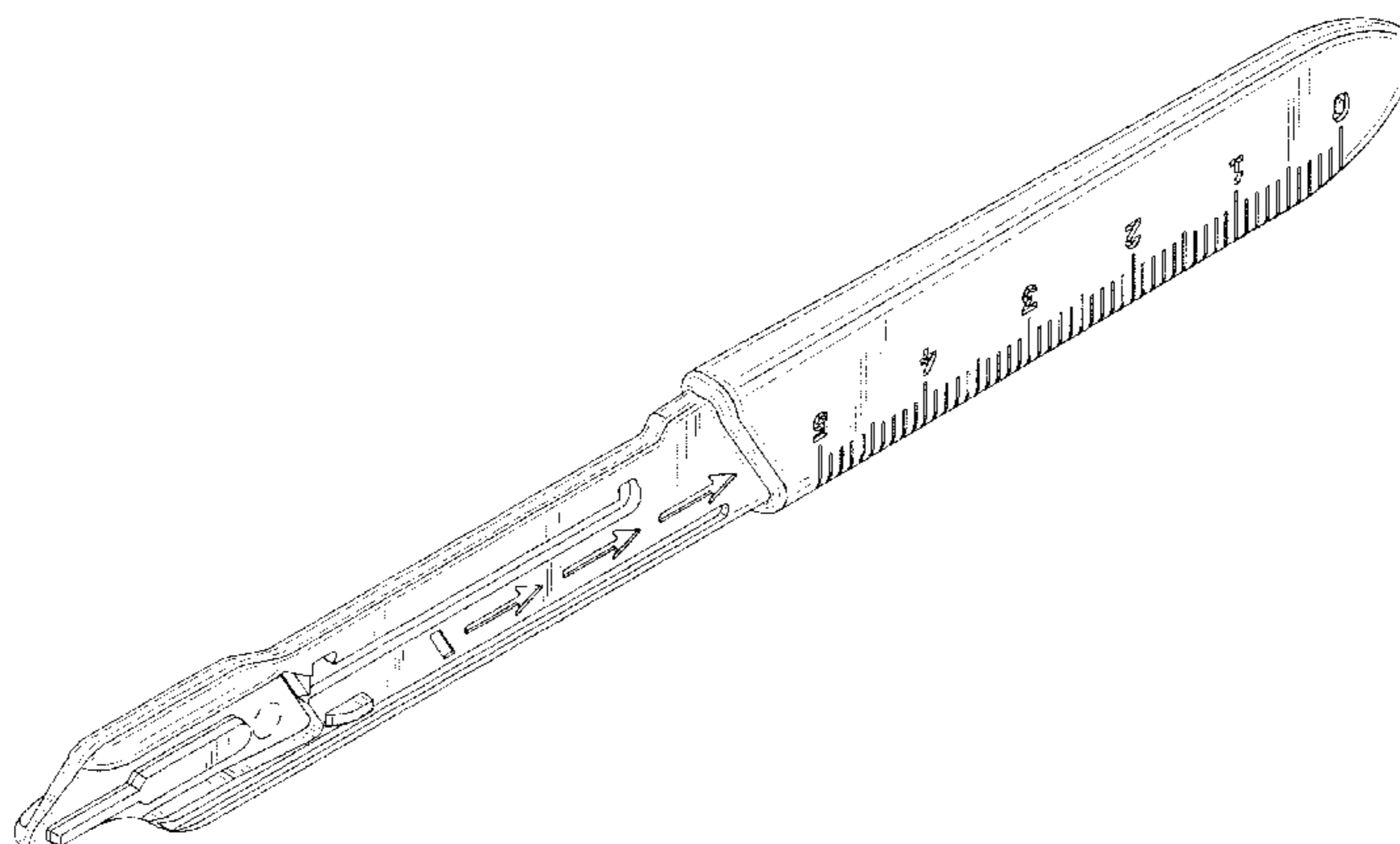

US D489,457 S

Page 2

U.S. PATENT DOCUMENTS

5,207,696 A	5/1993	Matwijcow	606/167	5,481,804 A	1/1996	Platts	30/162
5,250,063 A	10/1993	Abidin et al.	606/167	5,496,340 A	3/1996	Abidin et al.	606/167
5,250,064 A	10/1993	Schneider	606/167	5,571,127 A	11/1996	DeCampli	606/167
5,275,606 A	1/1994	Abidin et al.	606/167	5,591,189 A	1/1997	Yoon	606/185
5,292,310 A	3/1994	Yoon	604/158	5,620,454 A	4/1997	Pierce et al.	606/167
5,299,357 A	4/1994	Wonderley et al.	30/339	5,662,669 A	9/1997	Abidin et al.	606/167
5,309,641 A	5/1994	Wonderley et al.	30/339	5,674,203 A	10/1997	Lewandowski	604/197
5,312,429 A	5/1994	Noack	606/167	5,683,407 A	11/1997	Jolly et al.	606/181
5,330,492 A	7/1994	Haugen	606/167	5,741,289 A	4/1998	Jolly et al.	606/181
5,330,494 A	7/1994	van der Westhuizen et al.	606/167	5,752,968 A	5/1998	Jolly et al.	606/167
5,342,379 A	8/1994	Volinsky	606/167	5,792,162 A	8/1998	Jolly et al.	606/167
5,344,424 A	9/1994	Roberts et al.	606/167	5,827,309 A	10/1998	Jolly et al.	606/167
5,363,958 A	11/1994	Horan	206/356	5,868,771 A	2/1999	Herbert et al.	606/167
5,370,654 A	12/1994	Abidin et al.	606/182	5,908,432 A	6/1999	Pan	606/167
5,411,512 A	5/1995	Abidin et al.	606/167	5,938,676 A	8/1999	Cohn et al.	606/167
5,417,704 A	5/1995	Wonderley	606/167	5,957,944 A	9/1999	Khuri et al.	606/170
5,431,672 A	7/1995	Cote et al.	606/167	D470,938 S *	2/2003	Howell et al.	D24/147
5,449,068 A	9/1995	Gharibian	206/355	D475,135 S *	5/2003	Howell et al.	D24/147
				2002/0143352 A1 *	10/2002	Newman et al.	606/167

* cited by examiner

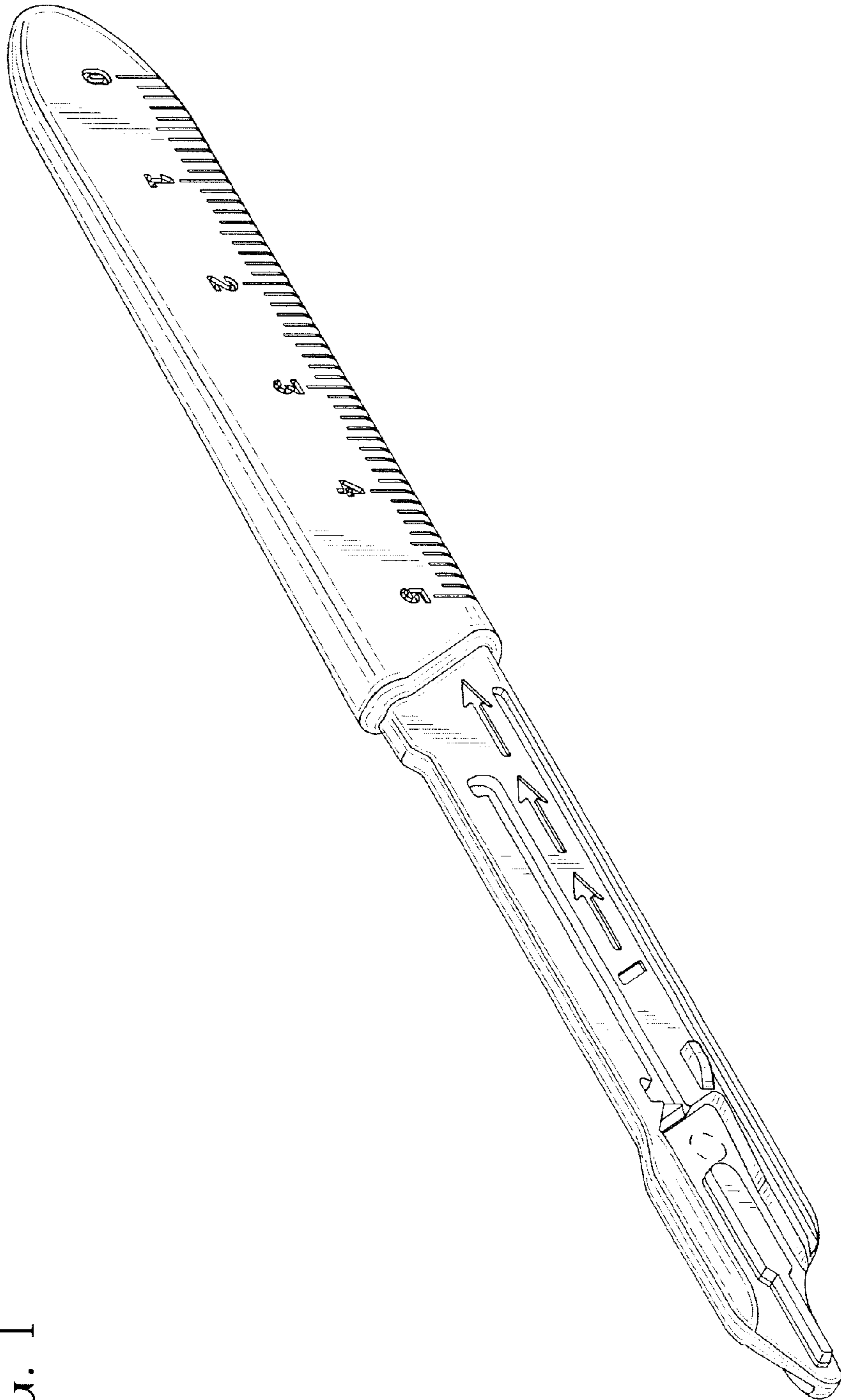

FIG. 1

FIG. 2

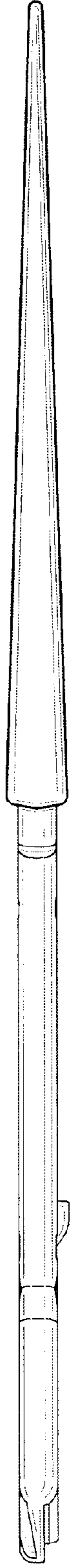

FIG. 3

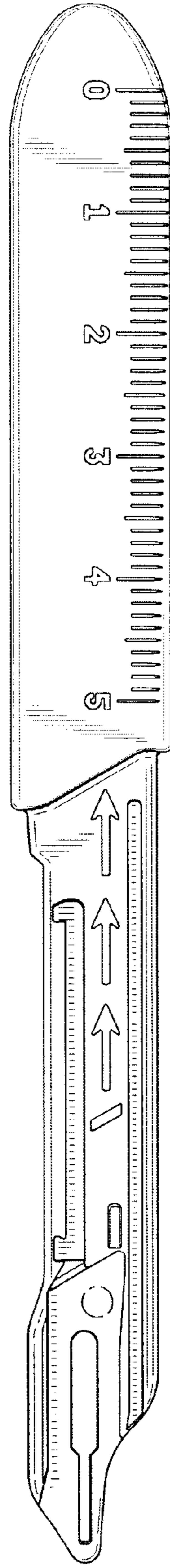

FIG. 4

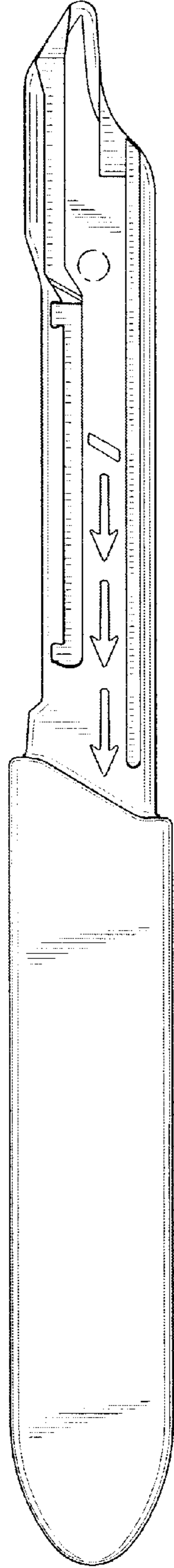

FIG. 5



FIG. 7

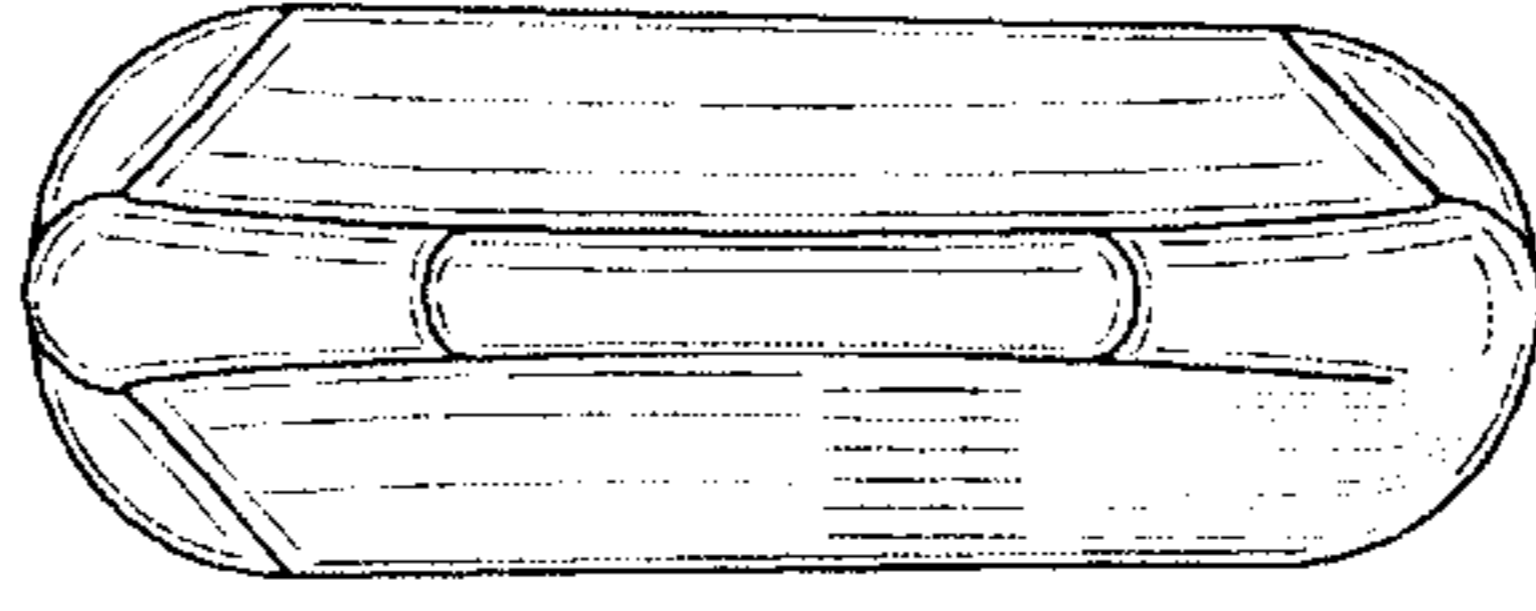

FIG. 6

