



US00D489402S

(12) **United States Design Patent**  
**Yamano et al.**

(10) **Patent No.:** **US D489,402 S**

(45) **Date of Patent:** **\*\* May 4, 2004**

(54) **PRINTER**

(75) Inventors: **Hirokazu Yamano**, Nagano-ken (JP);  
**Keisuke Inoue**, Nagano-ken (JP);  
**Daisuke Imai**, Nagano-ken (JP)

(73) Assignee: **Seiko Epson Corporation**, Tokyo (JP)

(\*\*) Term: **14 Years**

(21) Appl. No.: **29/165,869**

(22) Filed: **Aug. 20, 2002**

(30) **Foreign Application Priority Data**

Feb. 21, 2002 (JP) ..... 2002-004430

(51) **LOC (7) Cl.** ..... **14-02**

(52) **U.S. Cl.** ..... **D18/55**

(58) **Field of Search** ..... D18/36-39, 50,  
D18/53, 54-55; 400/613, 613.1-613.4,  
691-694, 690.1-690.4; D14/462-470, 420-430

(56) **References Cited**

**U.S. PATENT DOCUMENTS**

D400,918 S \* 11/1998 Kobayashi et al. .... D18/55  
6,089,772 A \* 7/2000 Takemura et al. .... 400/625

D430,597 S \* 9/2000 Ishiguro ..... D18/55  
D441,012 S \* 4/2001 Kawahara et al. .... D18/55  
D453,352 S \* 2/2002 Yamano et al. .... D18/55  
D468,764 S \* 1/2003 Miyahara et al. .... D18/54  
D468,765 S \* 1/2003 Kobayashi et al. .... D18/55

\* cited by examiner

*Primary Examiner*—Cathy Anne MacCormac

(74) *Attorney, Agent, or Firm*—Sughrue Mion, PLLC

(57) **CLAIM**

The ornamental design for a printer, as shown and described.

**DESCRIPTION**

FIG. 1 is a perspective view of the top, front and right side of printer showing our new design;  
FIG. 2 is a front elevational view thereof;  
FIG. 3 is a top plan view thereof;  
FIG. 4 is a left side elevational view thereof;  
FIG. 5 is a right side elevational view thereof;  
FIG. 6 is a bottom plan view thereof;  
FIG. 7 is a rear elevational view thereof; and,  
FIG. 8 is a view similar to FIG. 1 with the lower paper guide in the open and extended position.

**1 Claim, 4 Drawing Sheets**

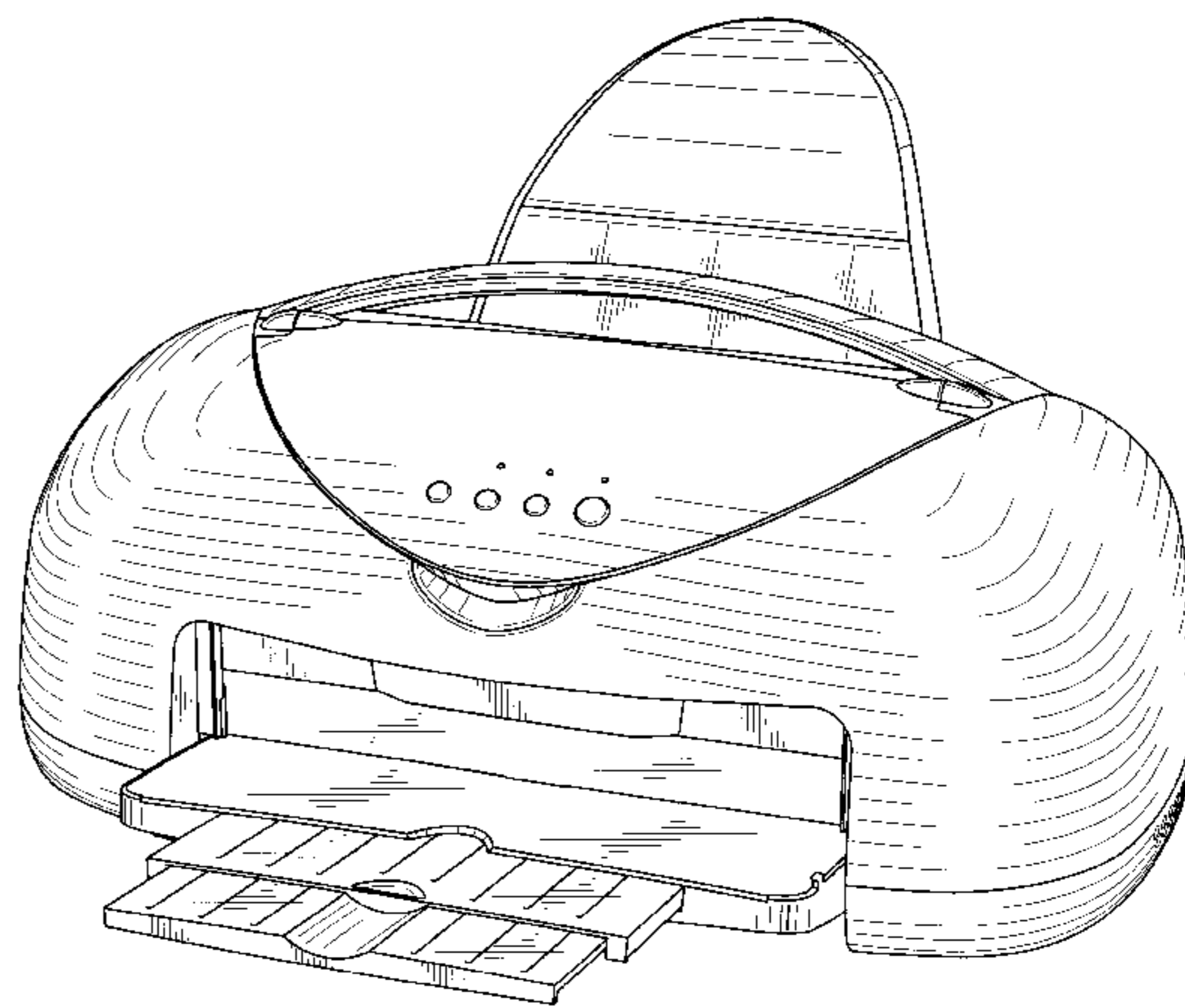
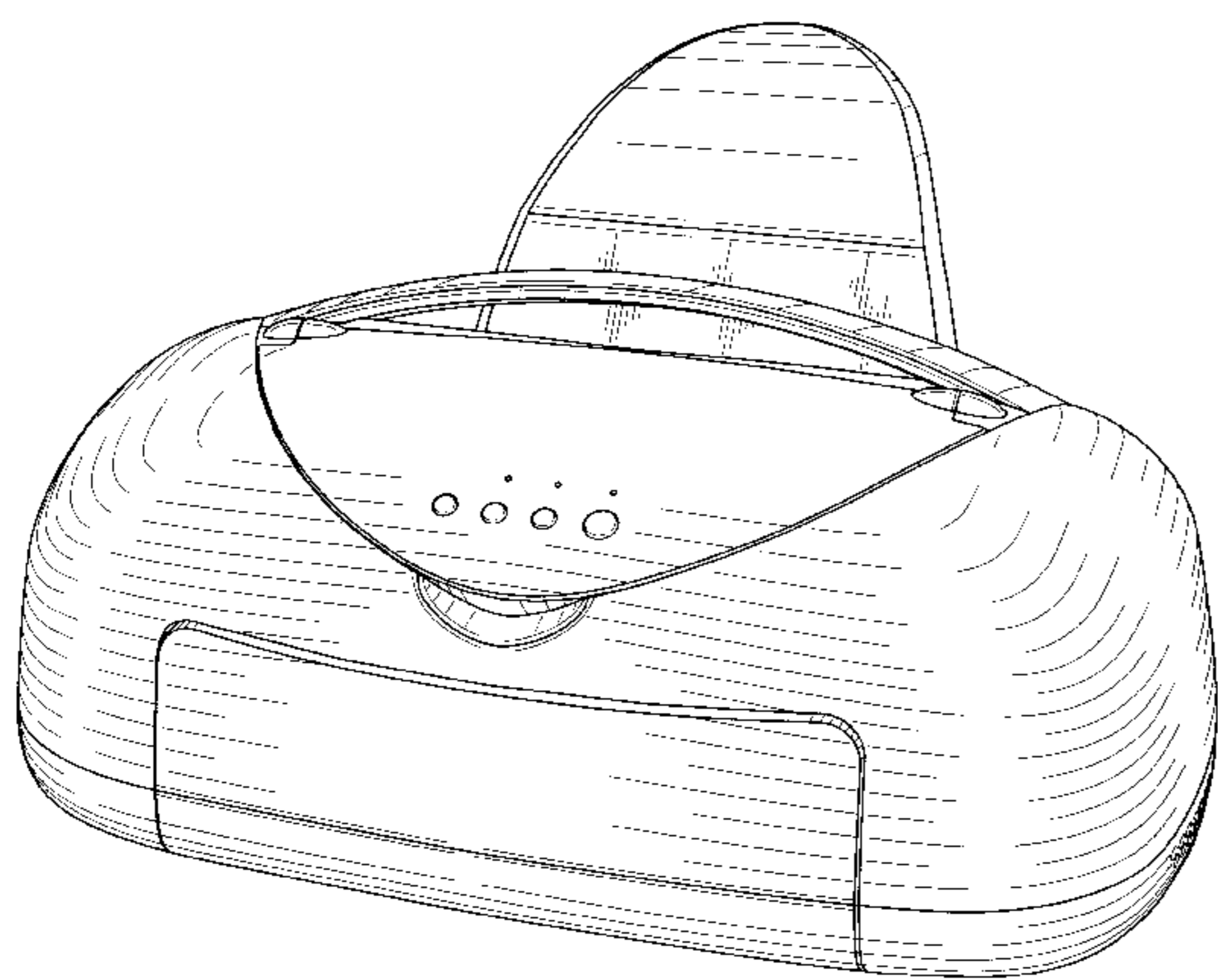

*FIG. 1*

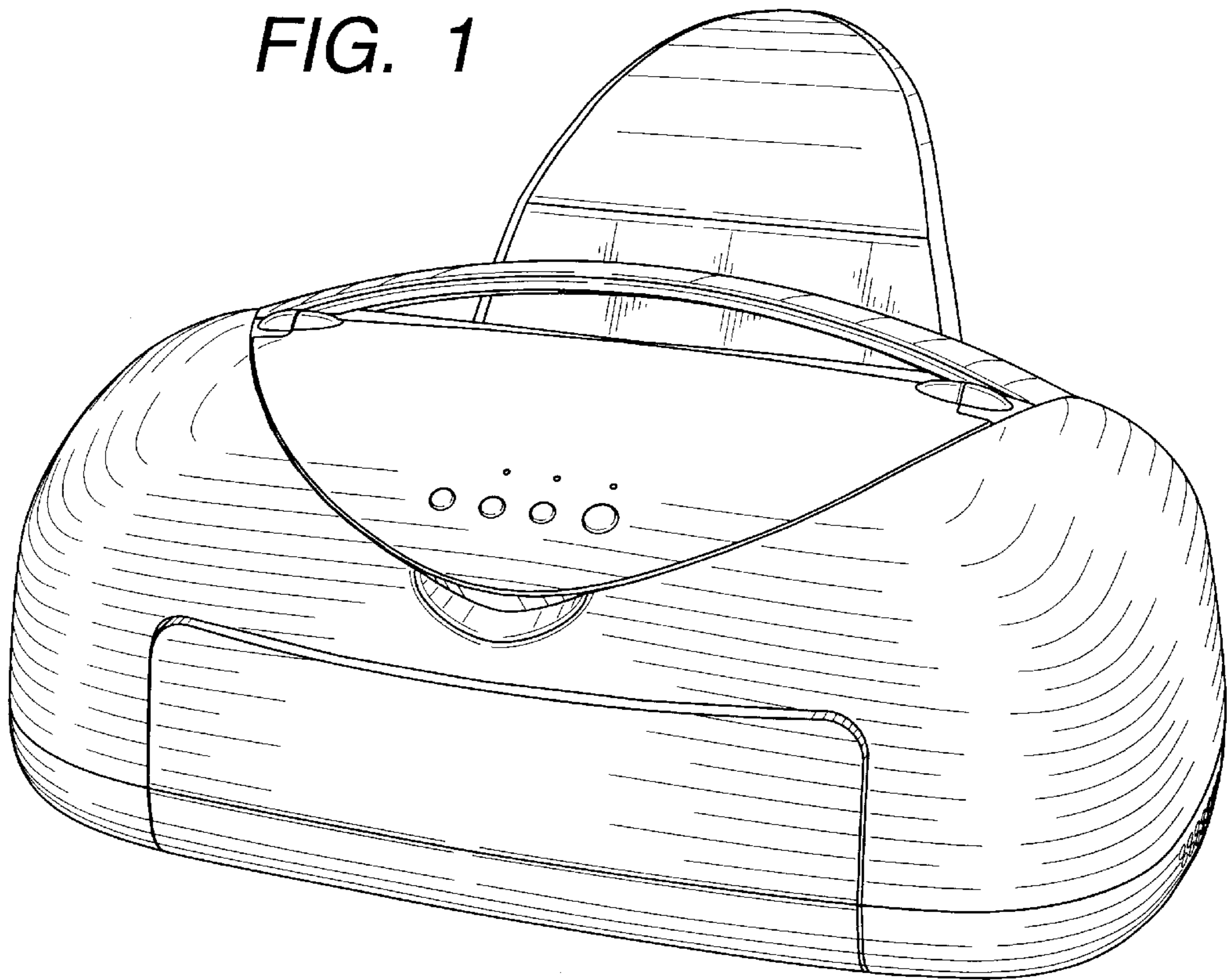

*FIG. 2*

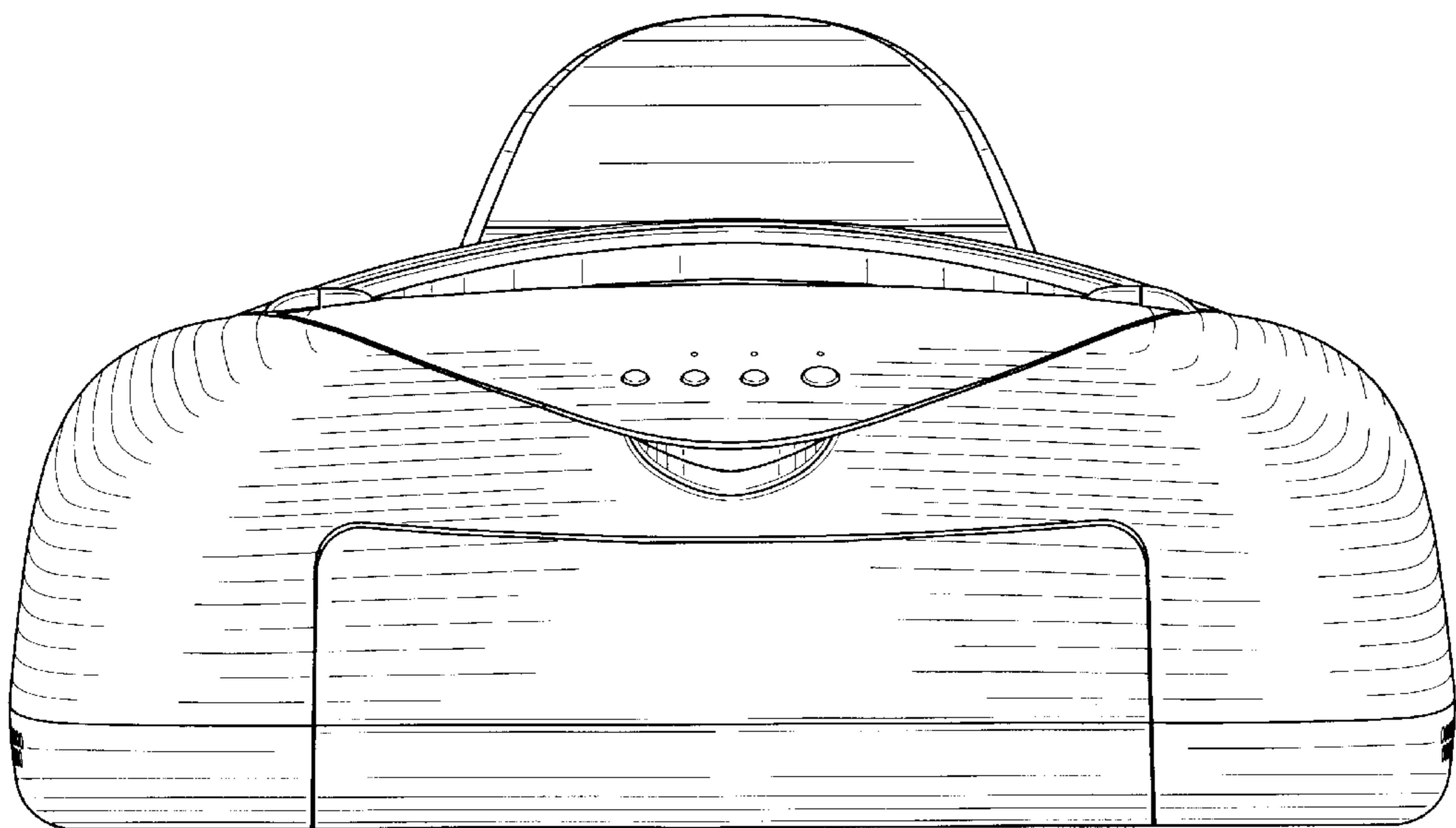

FIG. 3

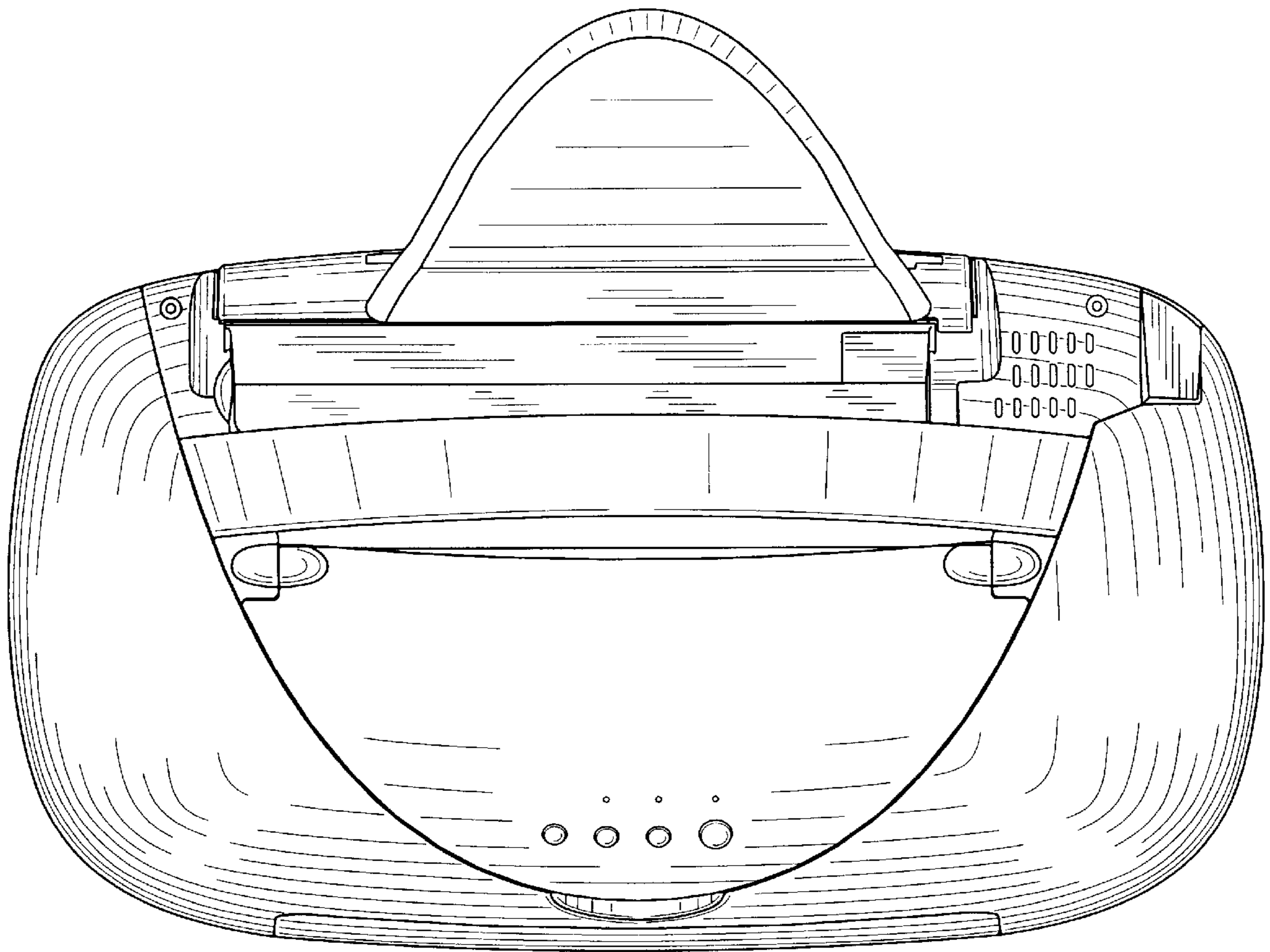
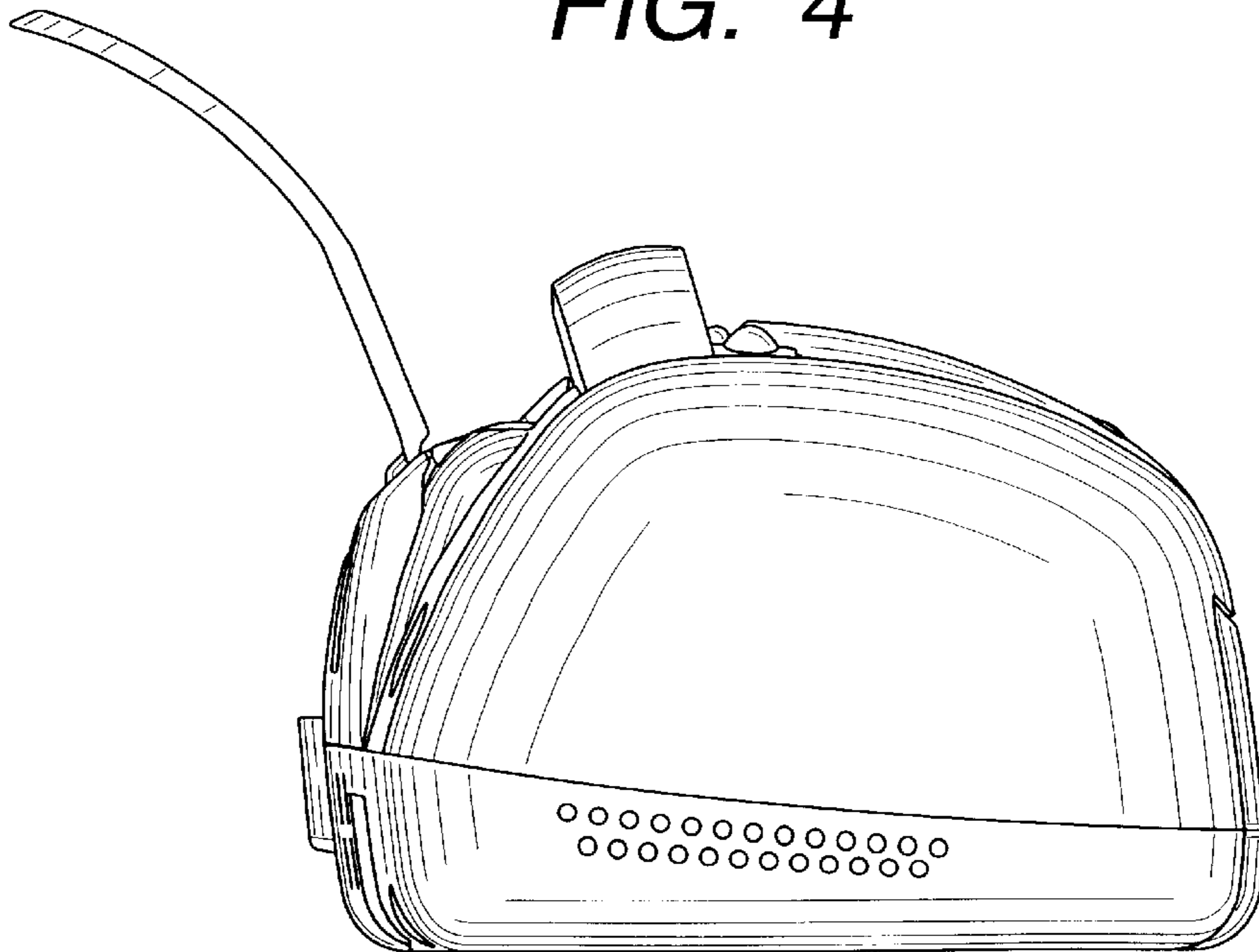
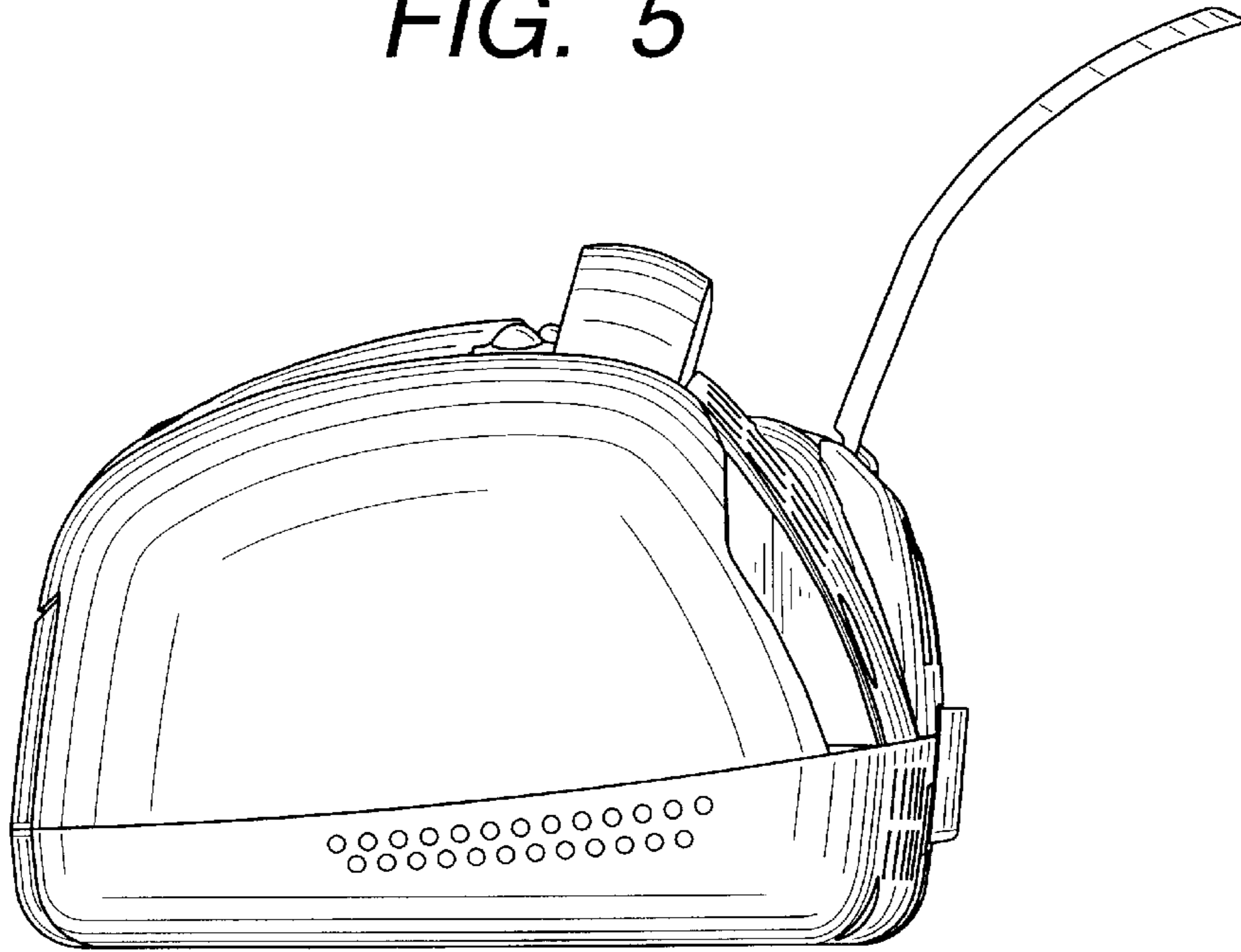

FIG. 4

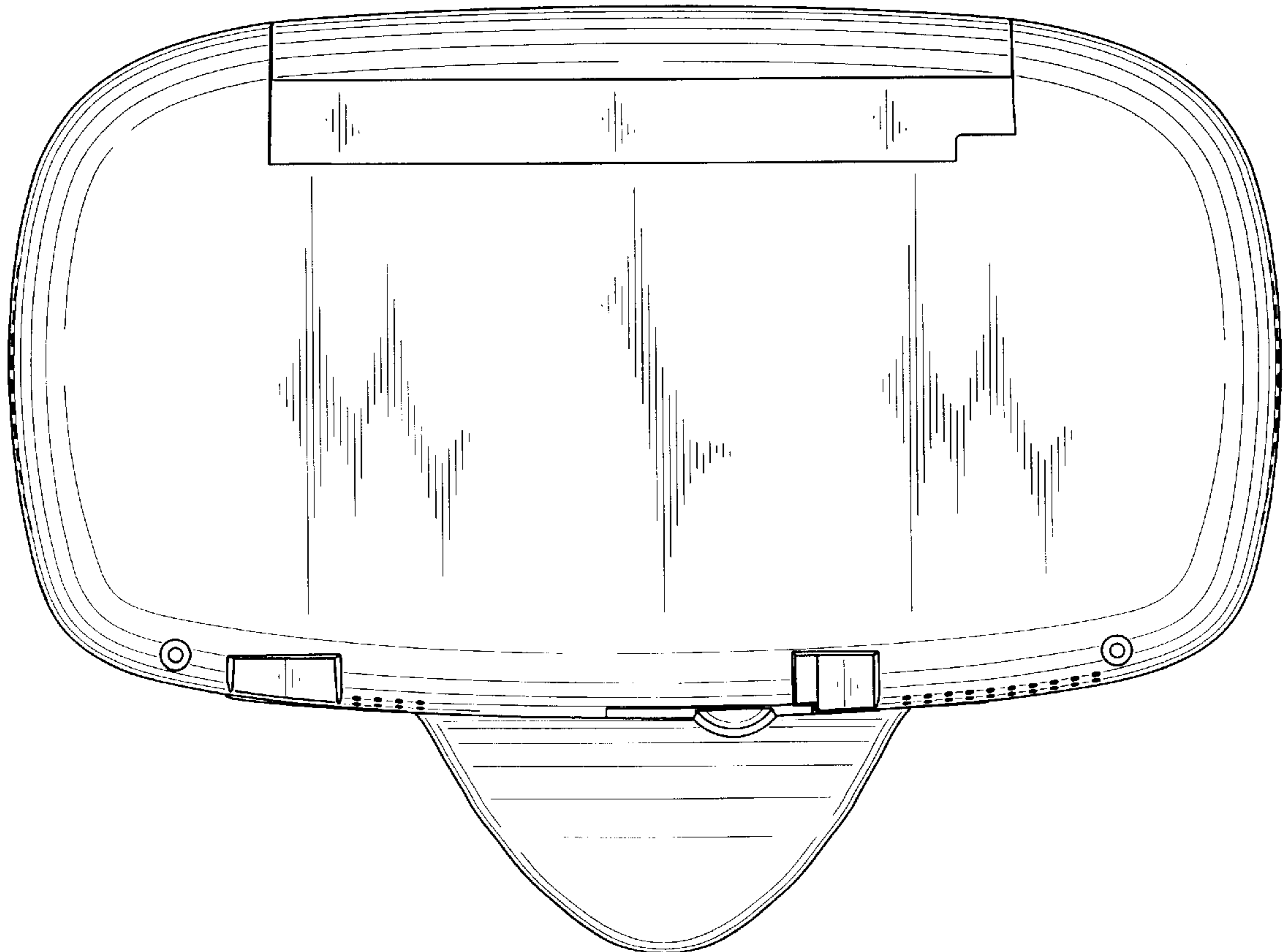



*FIG. 5*



*FIG. 6*



*FIG. 7*

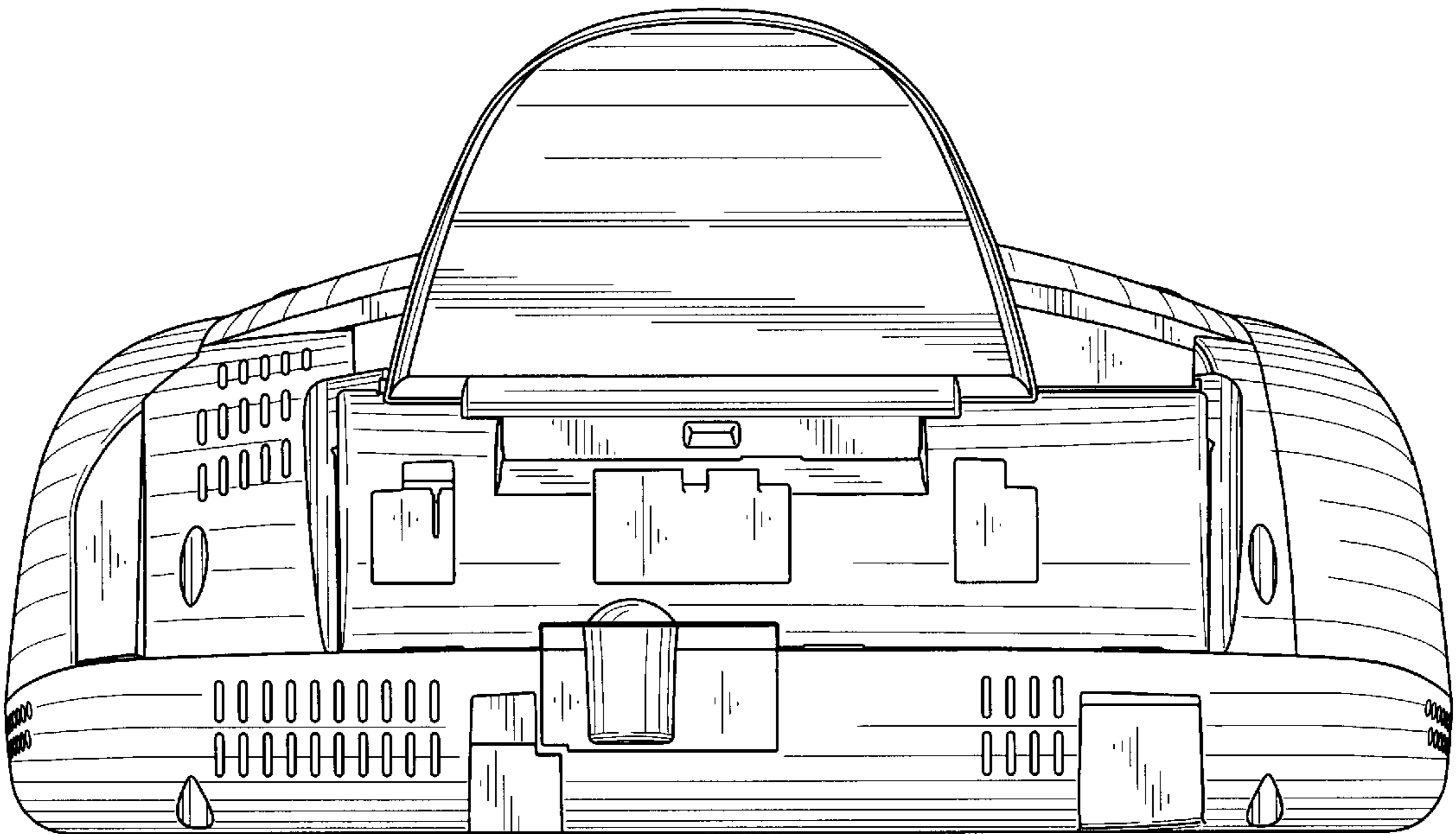

*FIG. 8*

