



US00D489348S

(12) **United States Design Patent**
Robertson, Jr. et al.

(10) **Patent No.:** **US D489,348 S**

(45) **Date of Patent:** **** May 4, 2004**

(54) **BASE FOR A COMMUNICATION DEVICE**

D432,106 S * 10/2000 Isonaga D14/149
D438,524 S * 3/2001 Batson, Jr. et al. D14/151

(75) Inventors: **William H. Robertson, Jr.**, Fort Lauderdale, FL (US); **Christopher G. Franck**, Decatur, GA (US); **Matthew M. Julian**, Deerfield Beach, FL (US)

* cited by examiner

Primary Examiner—Janice E. Seeger
(74) *Attorney, Agent, or Firm*—Design IP

(73) Assignee: **Motorola, Inc.**, Schaumburg, IL (US)

(57) **CLAIM**

(**) Term: **14 Years**

The ornamental design for a base for a communication device, as shown and described.

(21) Appl. No.: **29/188,479**

DESCRIPTION

(22) Filed: **Aug. 19, 2003**

FIG. 1 is an isometric view of an ornamental design of one embodiment of a base for a communication device showing our new design.

(51) **LOC (7) Cl.** **14-03**

(52) **U.S. Cl.** **D14/151**

FIG. 2 is a front orthographic view thereof.

(58) **Field of Search** D14/149–151,

D14/144, 243, 146, 130, 329, 330; 379/202.01,

420.01, 420.02, 420.03, 428.01, 428.02,

428.03, 419, 434, 436, 440

FIG. 3 is a left side orthographic view thereof.

FIG. 4 is a right side orthographic view thereof.

FIG. 5 is a top orthographic view thereof.

FIG. 6 is a bottom orthographic view thereof; and,

FIG. 7 is a rear orthographic view thereof.

The broken lines shown in FIGS. 1–7 are included for the purpose of illustrating environmental elements only and form no part of the claimed design.

(56) **References Cited**

U.S. PATENT DOCUMENTS

D259,421 S * 6/1981 Janda D14/149

D294,253 S * 2/1988 Read D14/150

1 Claim, 4 Drawing Sheets

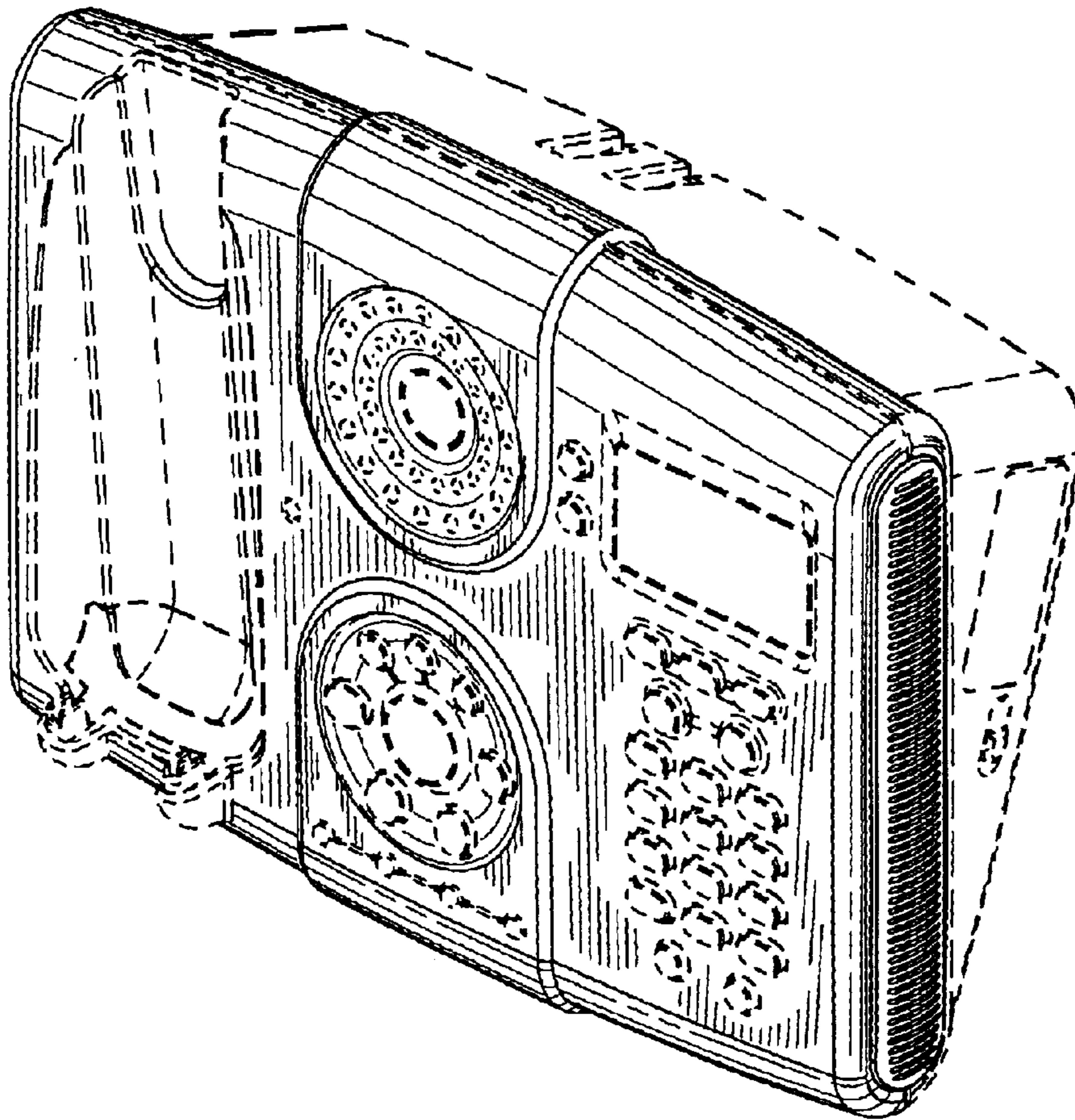

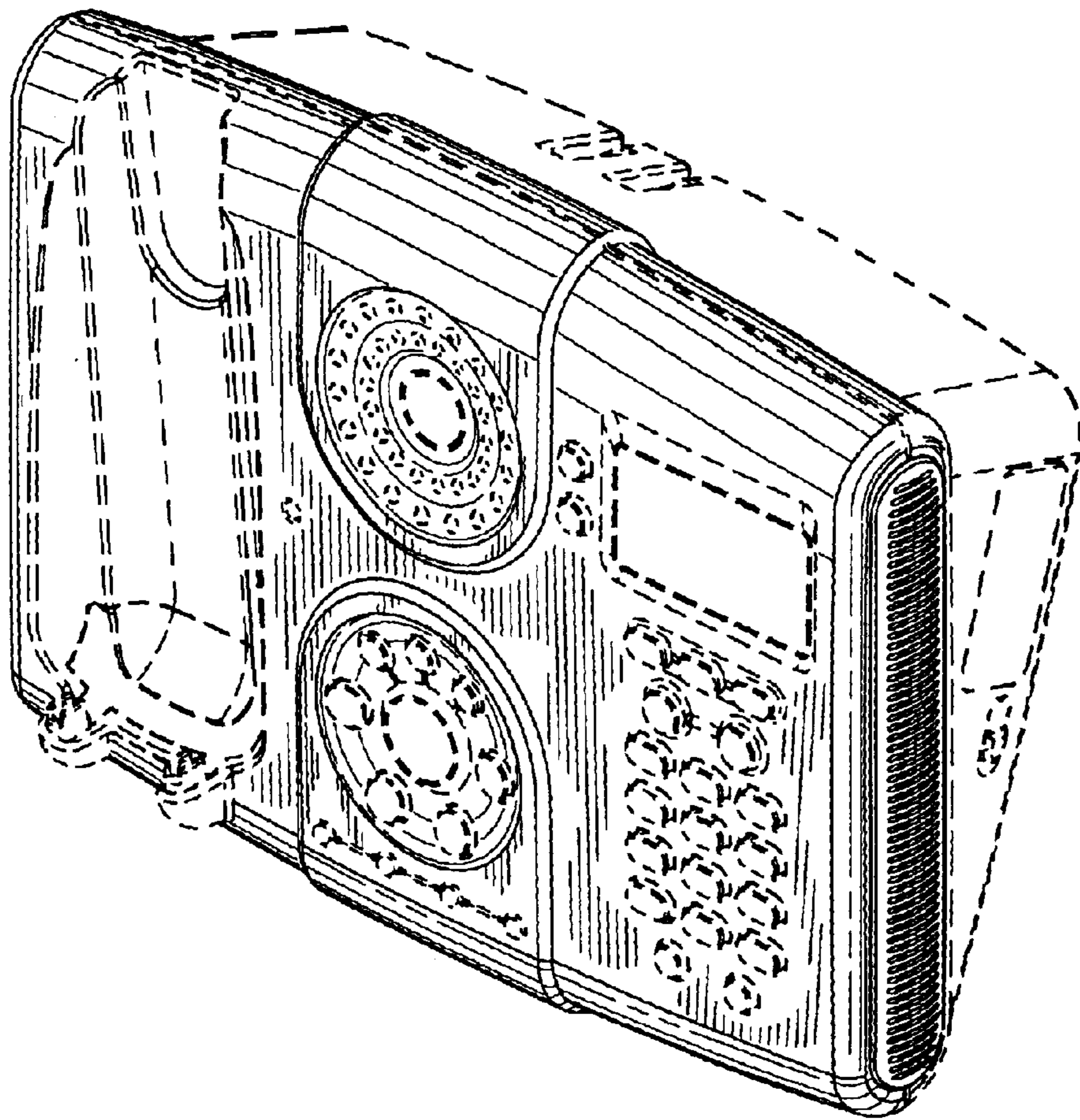

FIG. 1

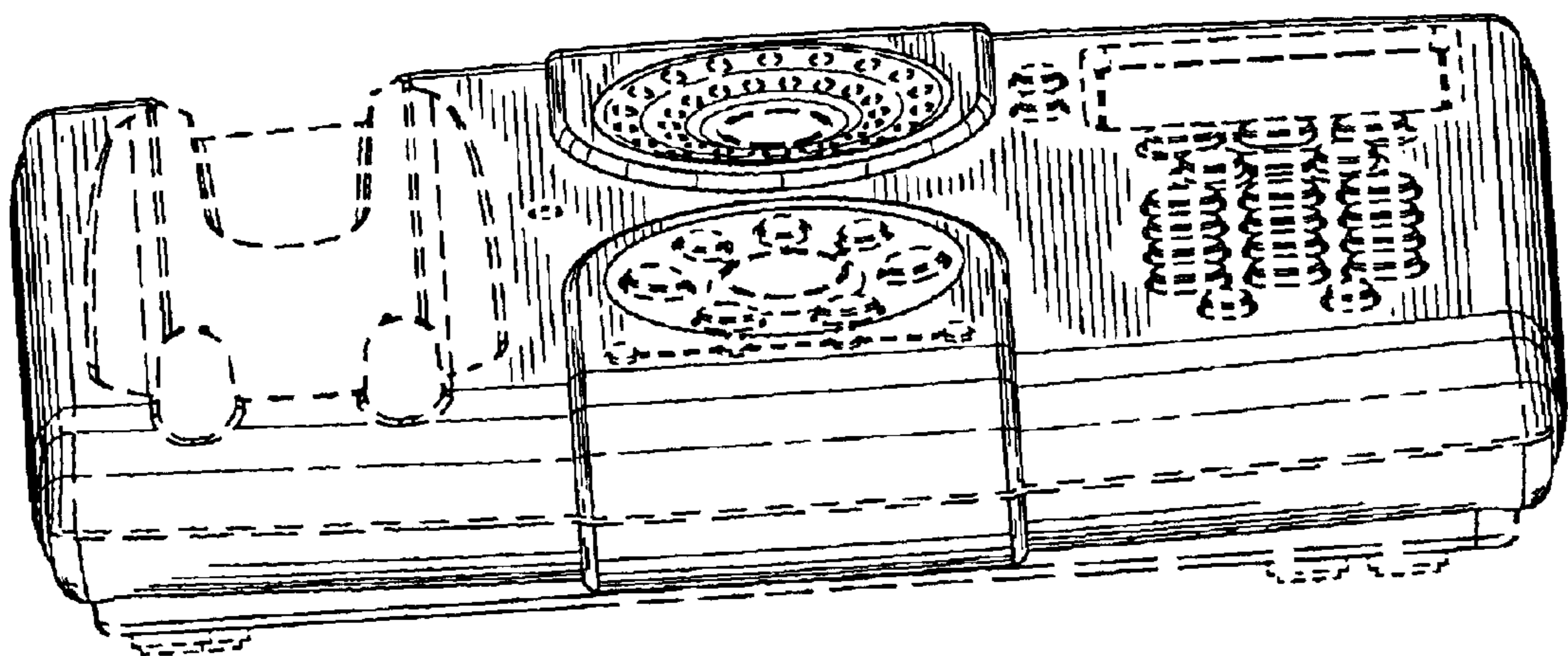

FIG. 2

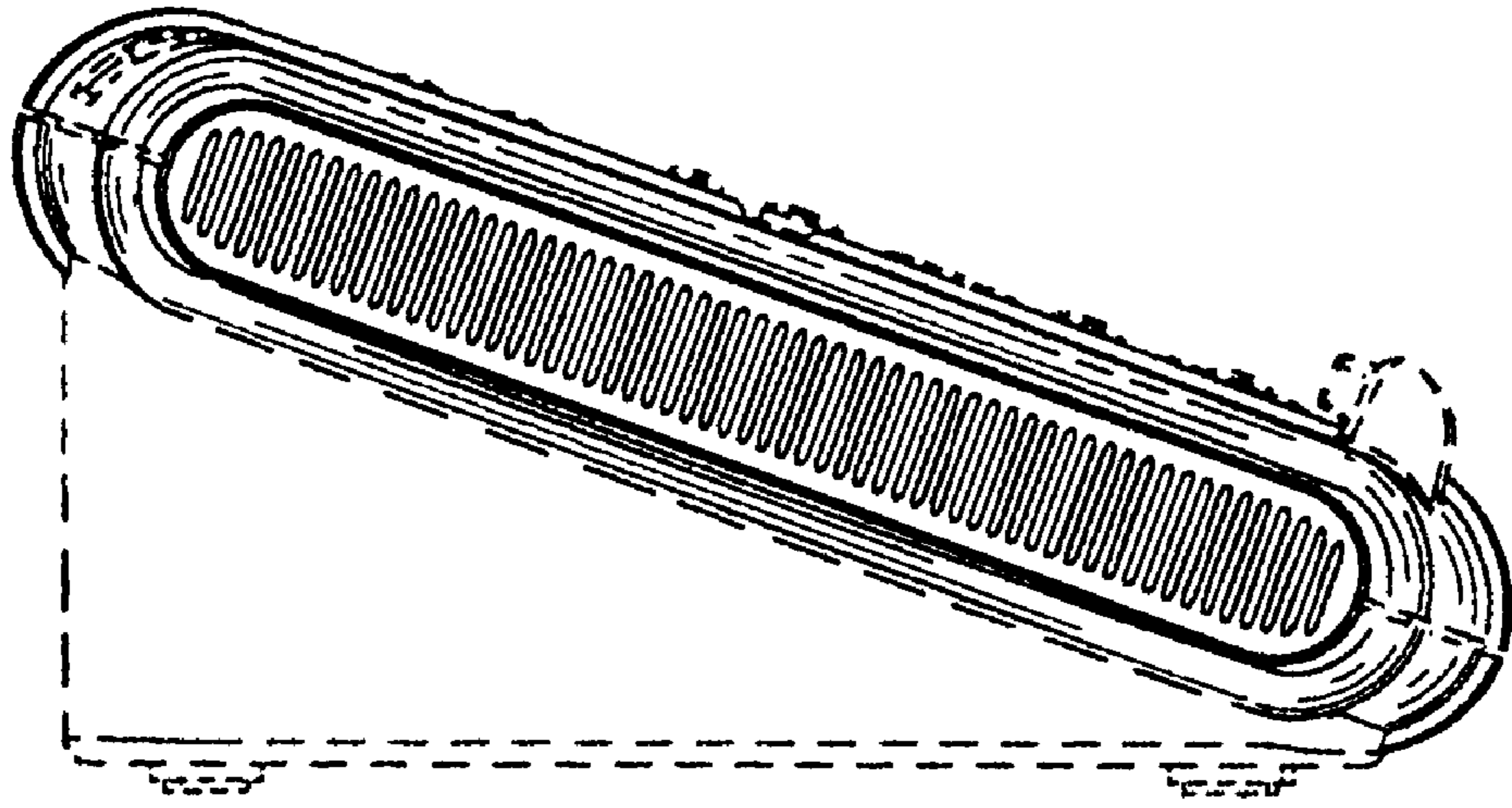

FIG. 3

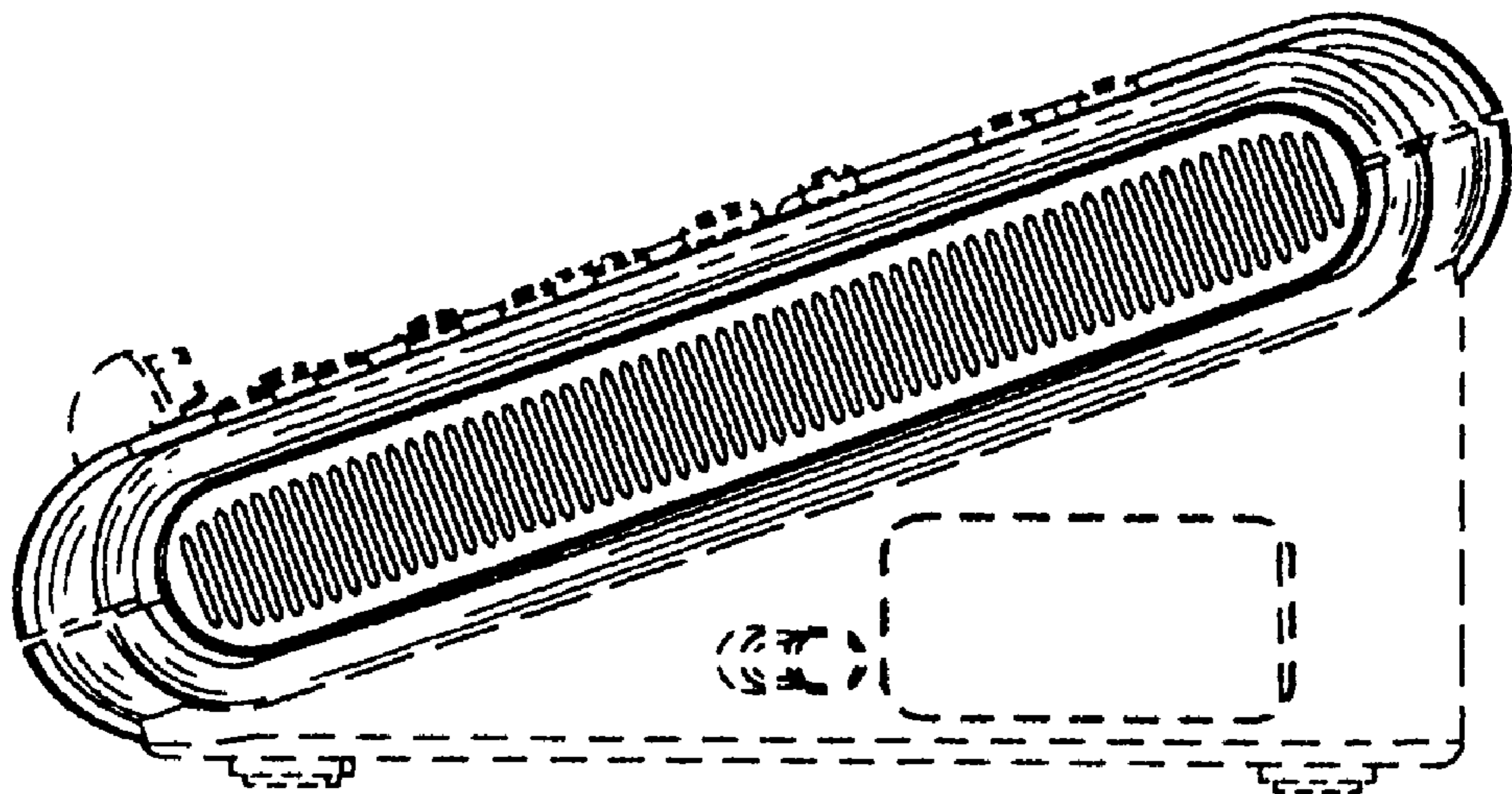

FIG. 4

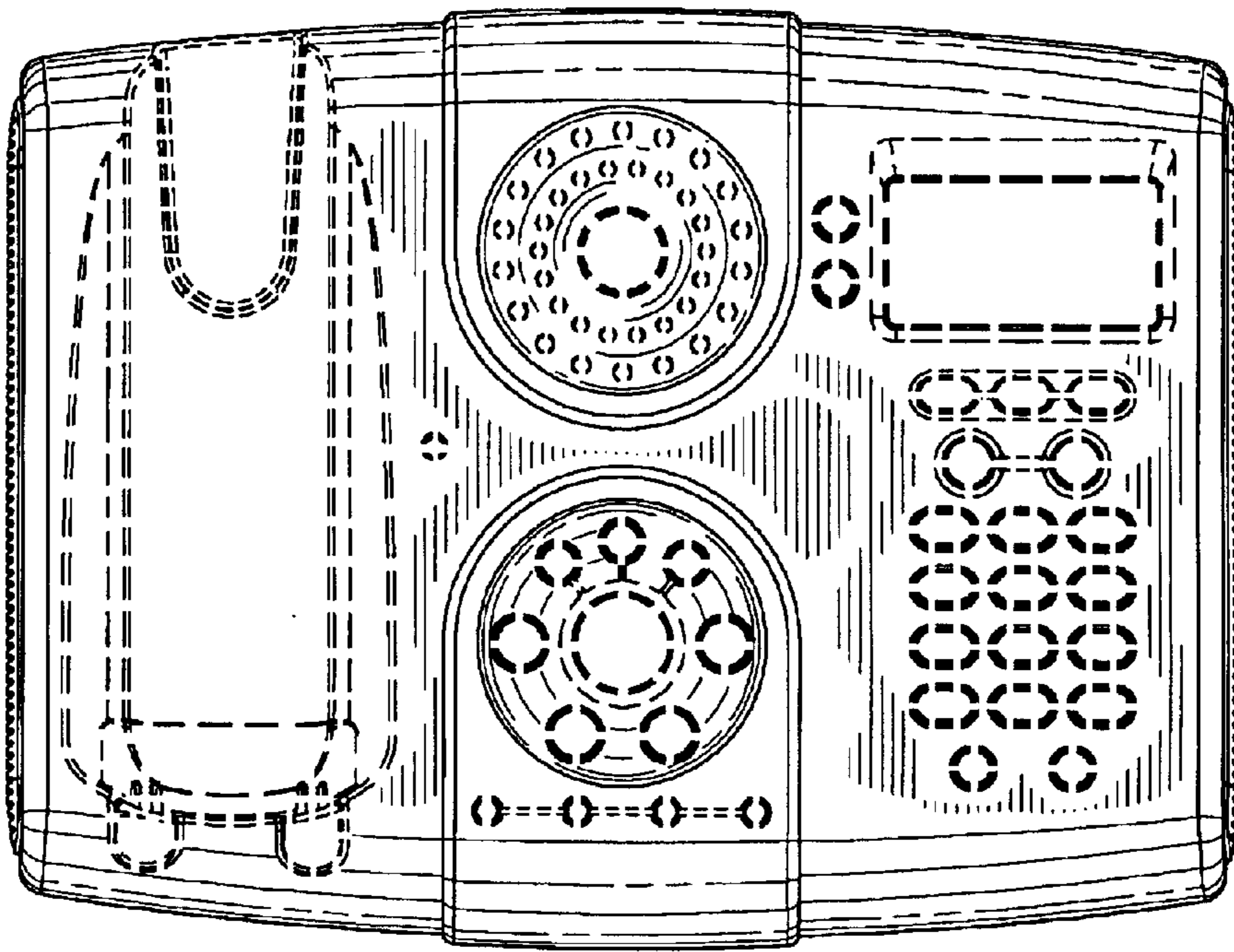

FIG. 5

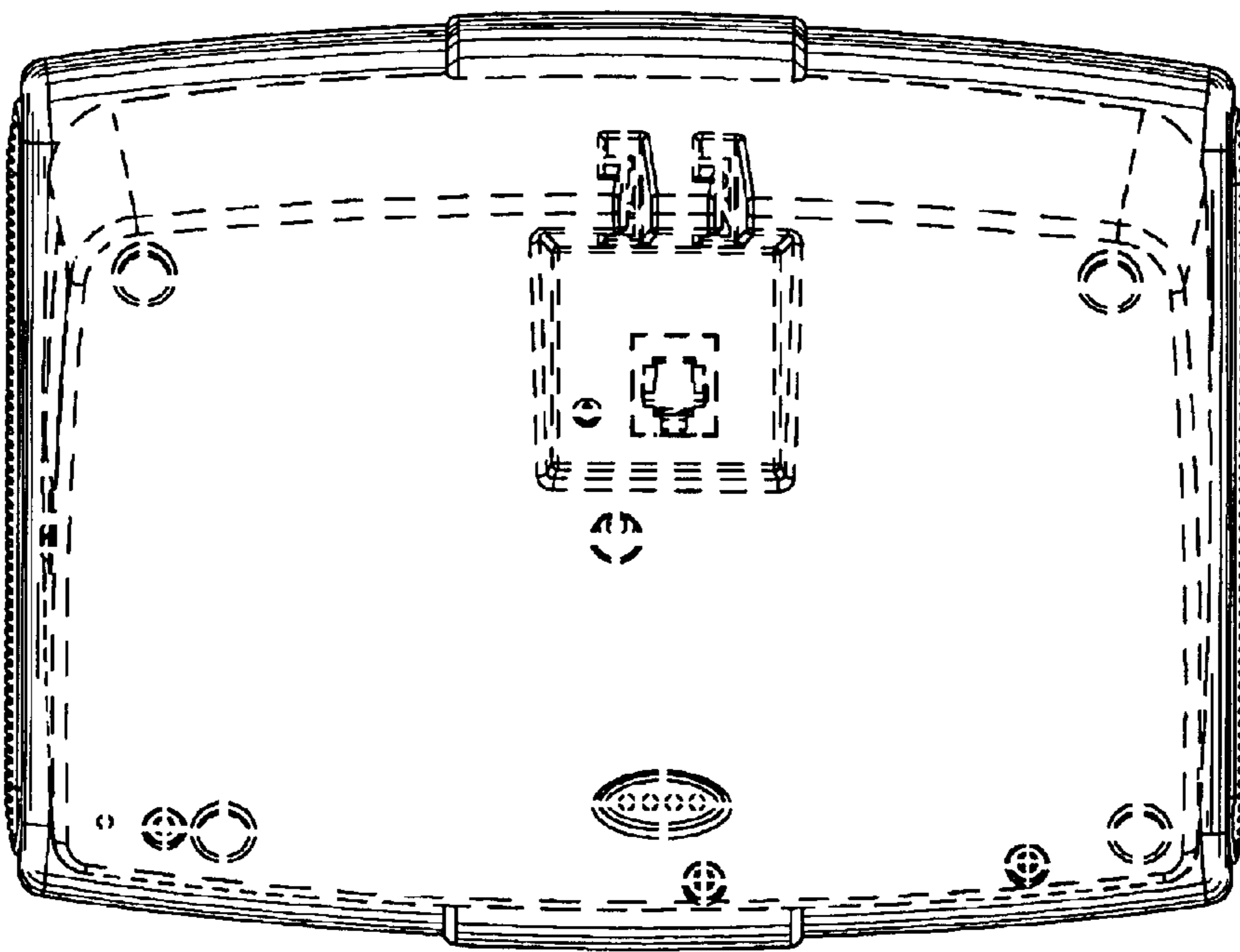

FIG. 6

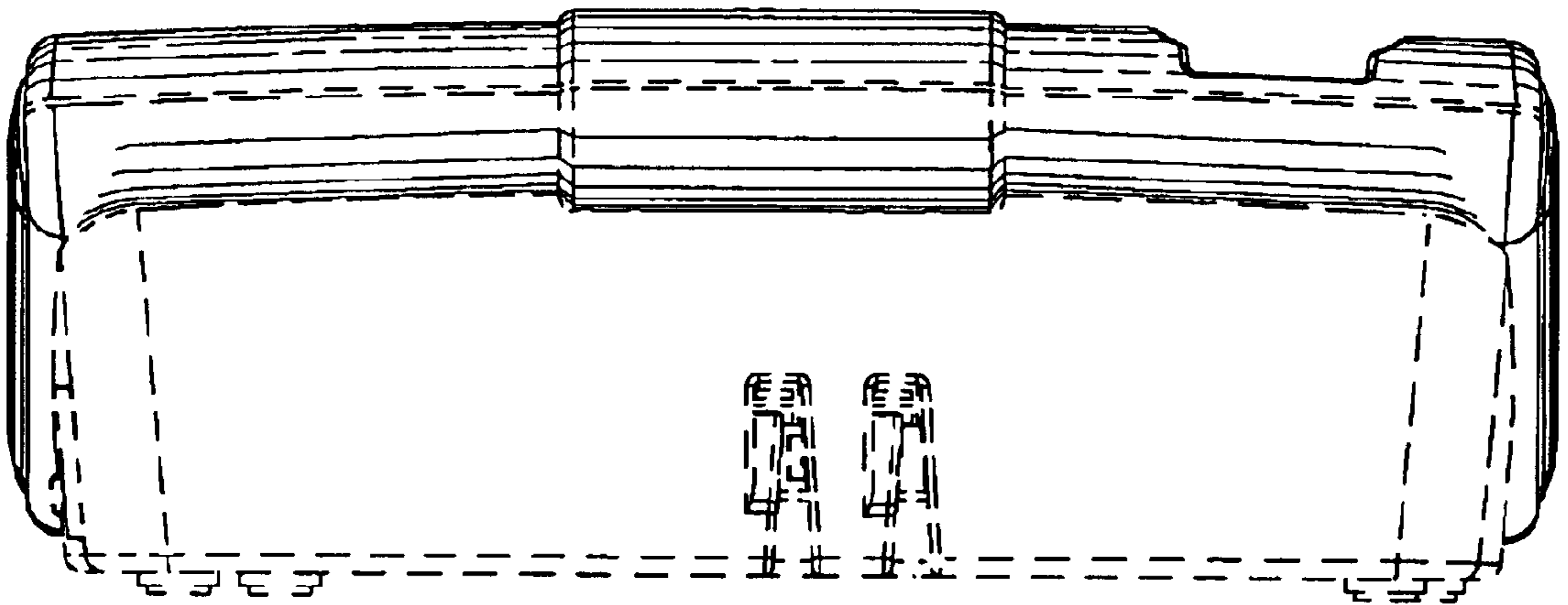

FIG. 7