



US00D489222S

(12) **United States Design Patent**
Pai

(10) **Patent No.:** **US D489,222 S**

(45) **Date of Patent:** **** May 4, 2004**

(54) **ROASTER**

(76) Inventor: **Lucas Pai**, 8 Fl.-2, No. 160, Sec. 1,
Chung-Kang Rd., Taichung (TW)

(**) Term: **14 Years**

(21) Appl. No.: **29/177,922**

(22) Filed: **Mar. 17, 2003**

(51) **LOC (7) Cl.** **07-02**

(52) **U.S. Cl.** **D7/334**

(58) **Field of Search** D7/323, 332-337,
D7/354, 402-404; 126/25 R, 25 A, 25 AA,
38, 37 A, 41 R, 40; 99/450, 481-482

(56) **References Cited**

U.S. PATENT DOCUMENTS

- D316,355 S * 4/1991 Stephen et al. D7/334
- D437,176 S * 2/2001 Bullard D7/334
- D461,359 S * 8/2002 Coleman et al. D7/334
- D462,227 S * 9/2002 Alden et al. D7/334
- D466,756 S * 12/2002 Bossler et al. D7/334

- D470,357 S * 2/2003 Home D7/334
- D471,057 S * 3/2003 Chung D7/334
- D472,756 S * 4/2003 Pai D7/334
- D475,235 S * 6/2003 Home D7/334

* cited by examiner

Primary Examiner—Ruth McInroy

(74) *Attorney, Agent, or Firm*—Dellett & Walters

(57) **CLAIM**

The ornamental design for a roaster, as shown.

DESCRIPTION

FIG. 1 is a perspective view of the roaster showing my new design;
 FIG. 2 is a front elevational view thereof;
 FIG. 3 is a rear elevational view thereof;
 FIG. 4 is a left side view thereof;
 FIG. 5 is a right side view thereof;
 FIG. 6 is a top plain view thereof; and,
 FIG. 7 is a bottom plain view thereof.

1 Claim, 6 Drawing Sheets

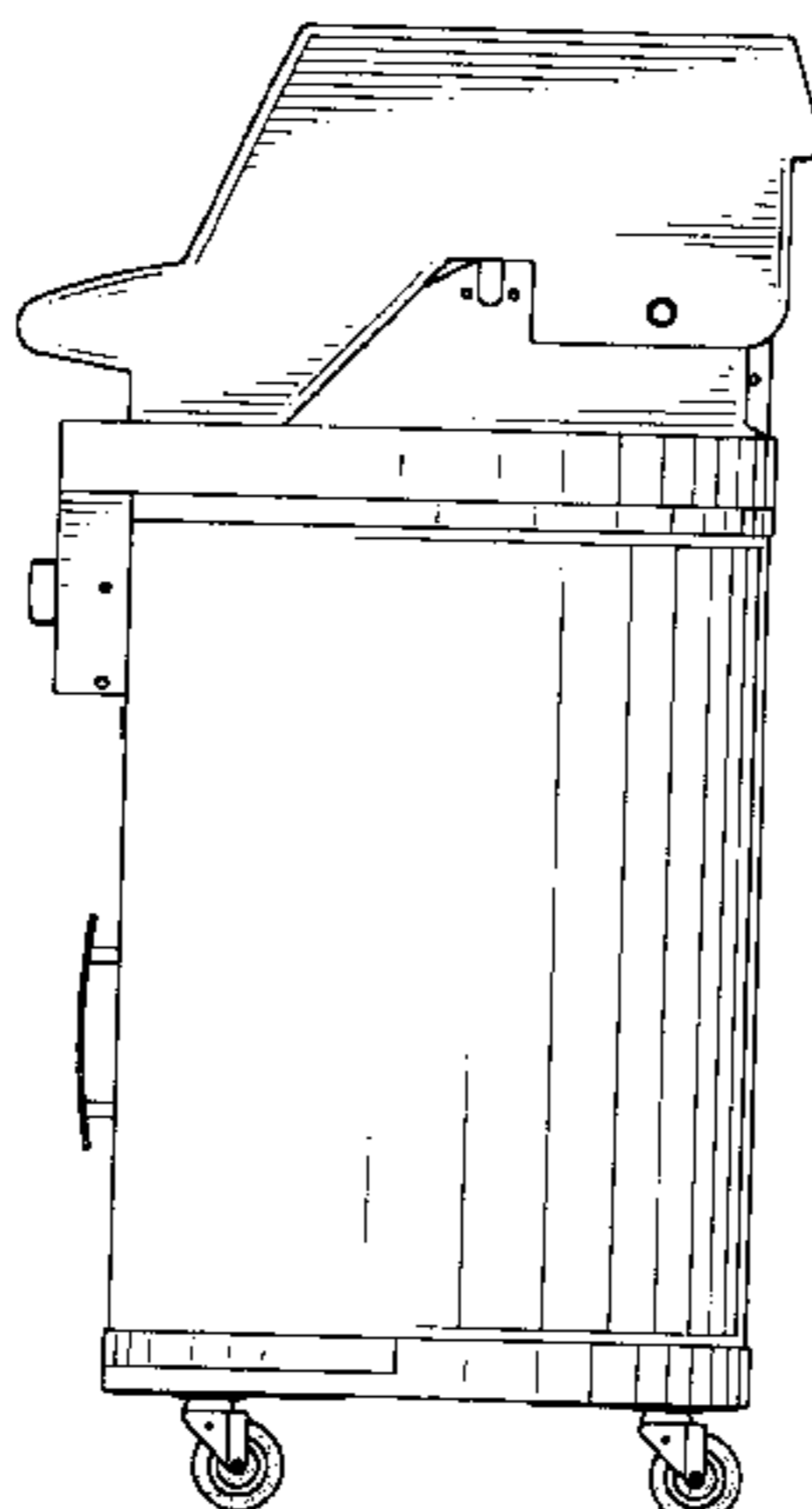
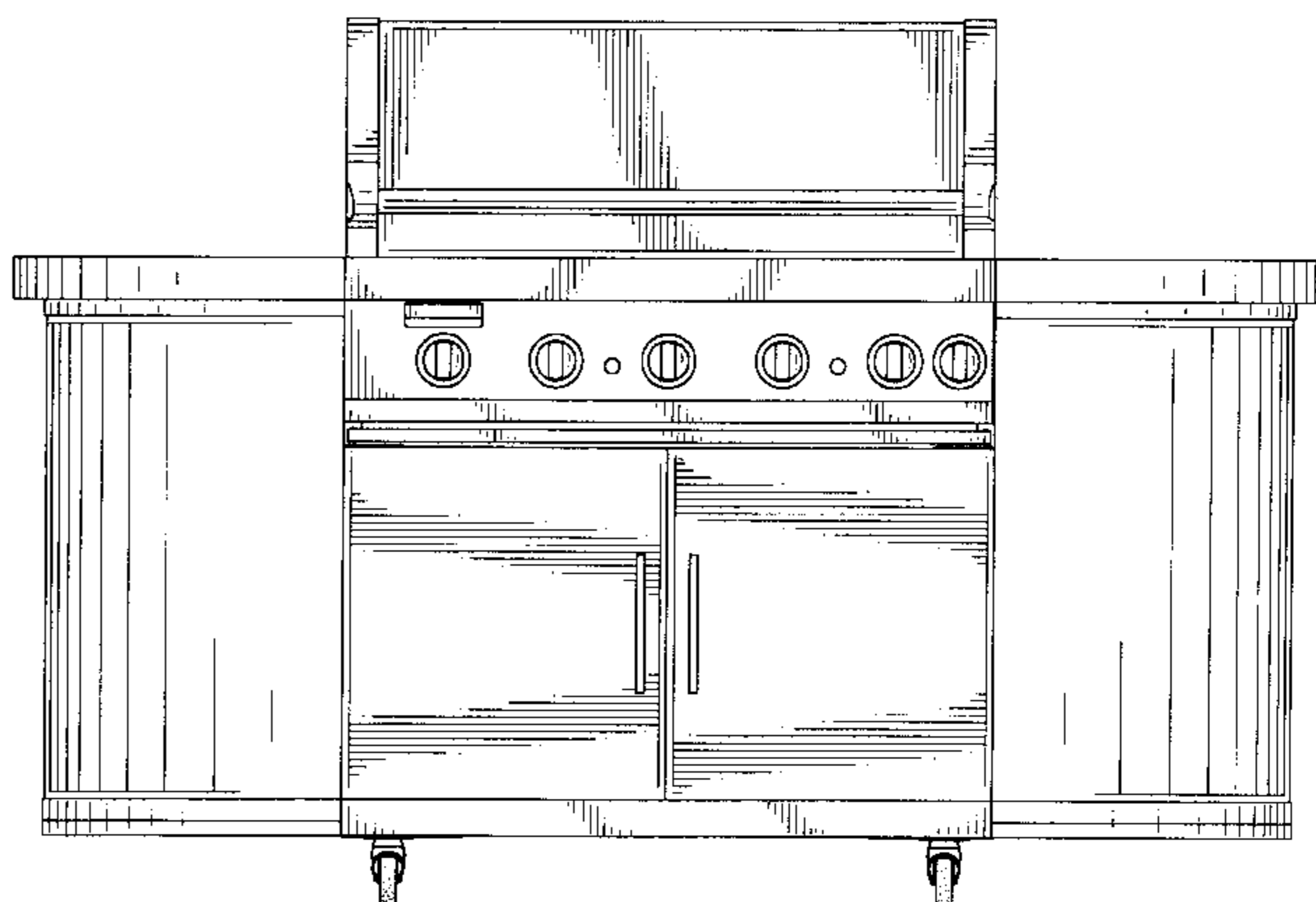
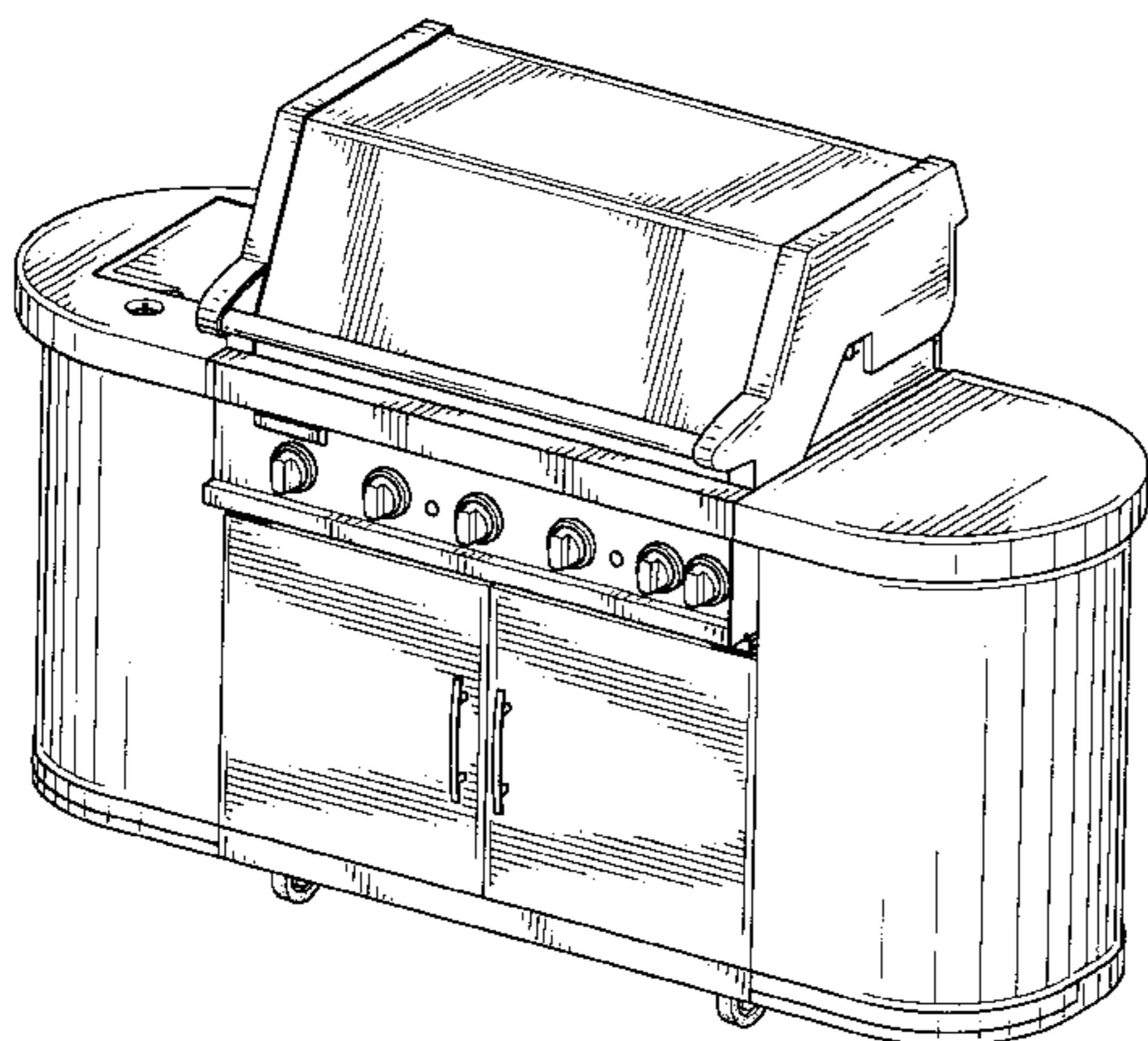

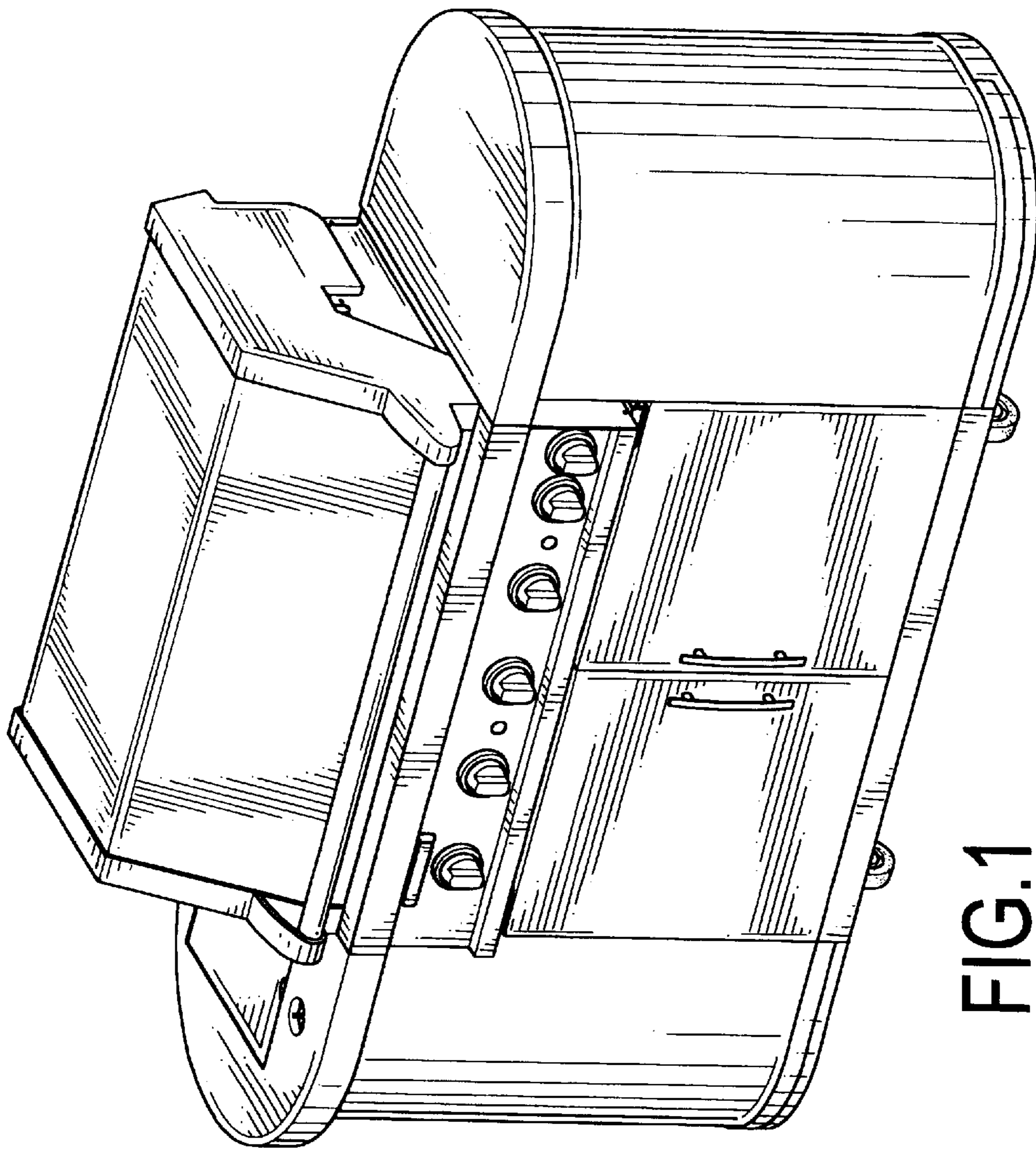

FIG.1

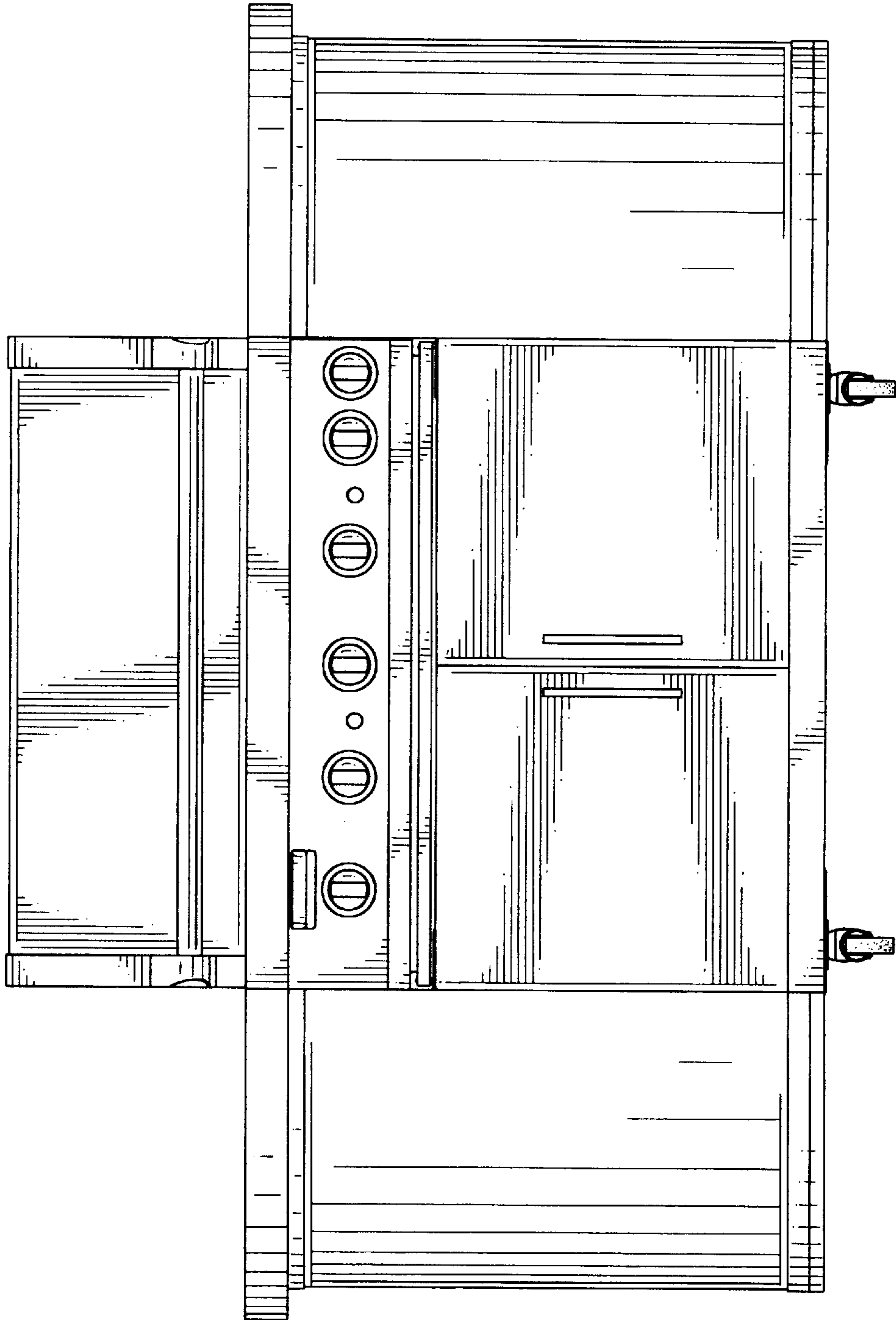

FIG.2

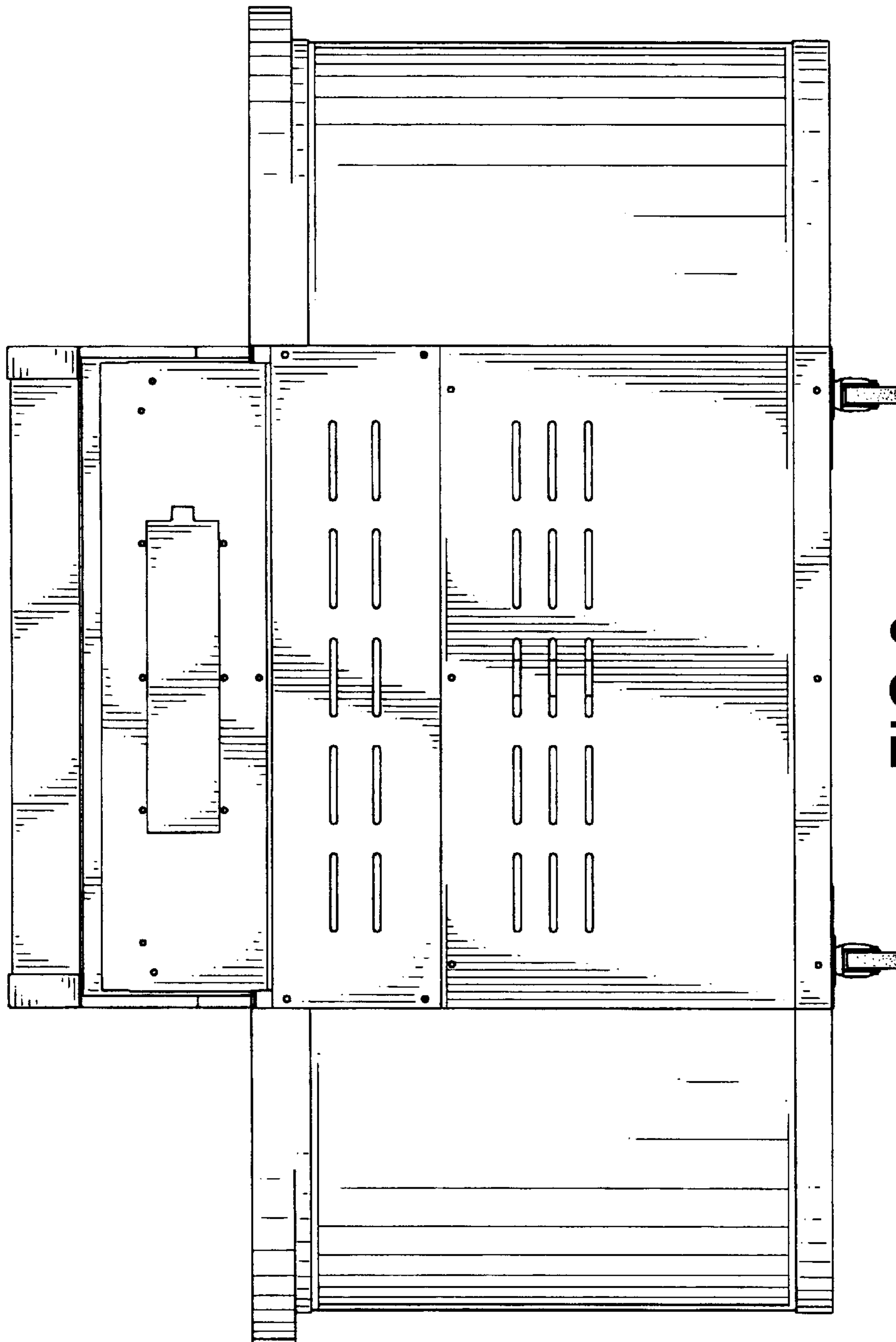

FIG.3

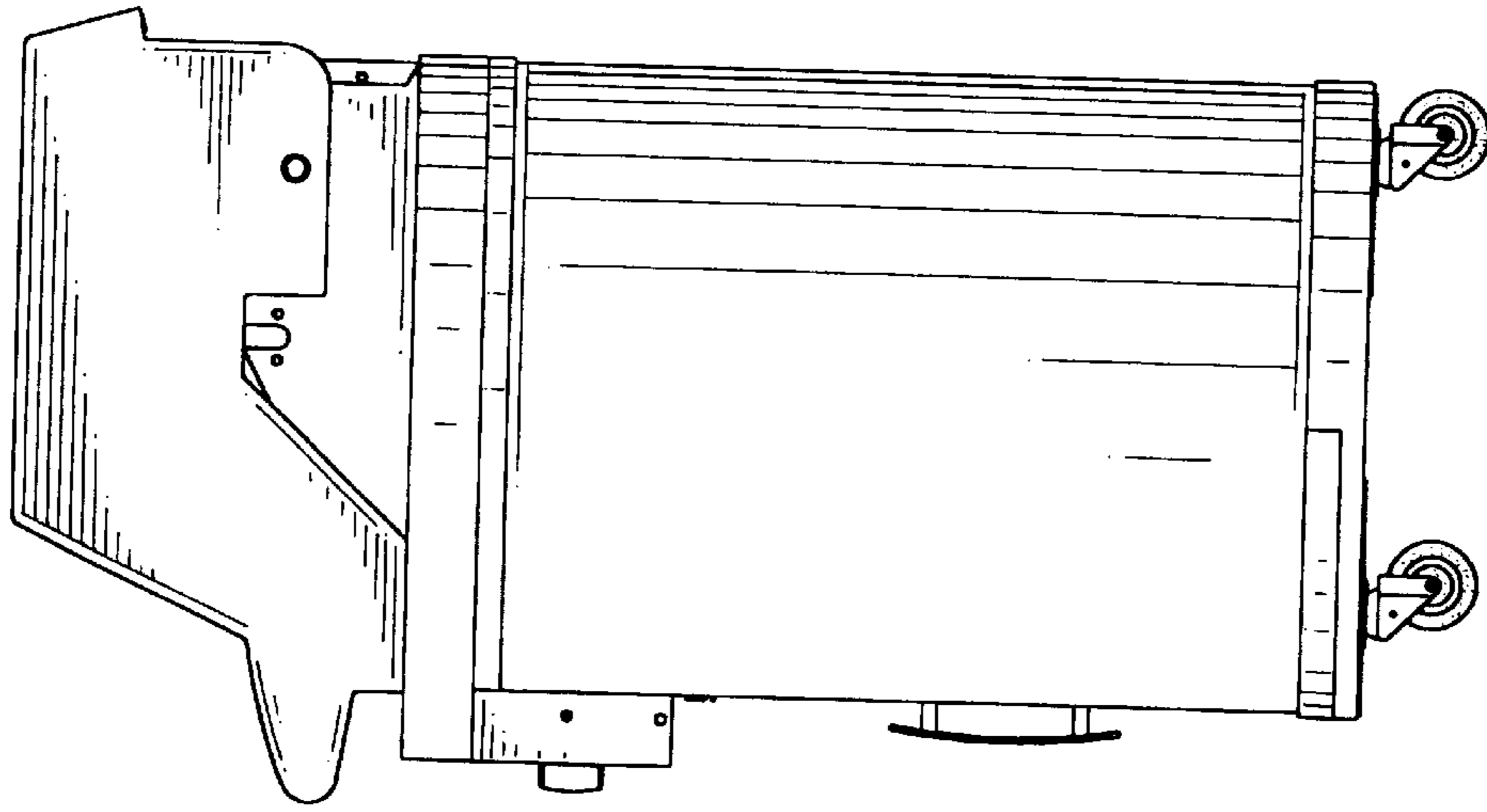

FIG.5

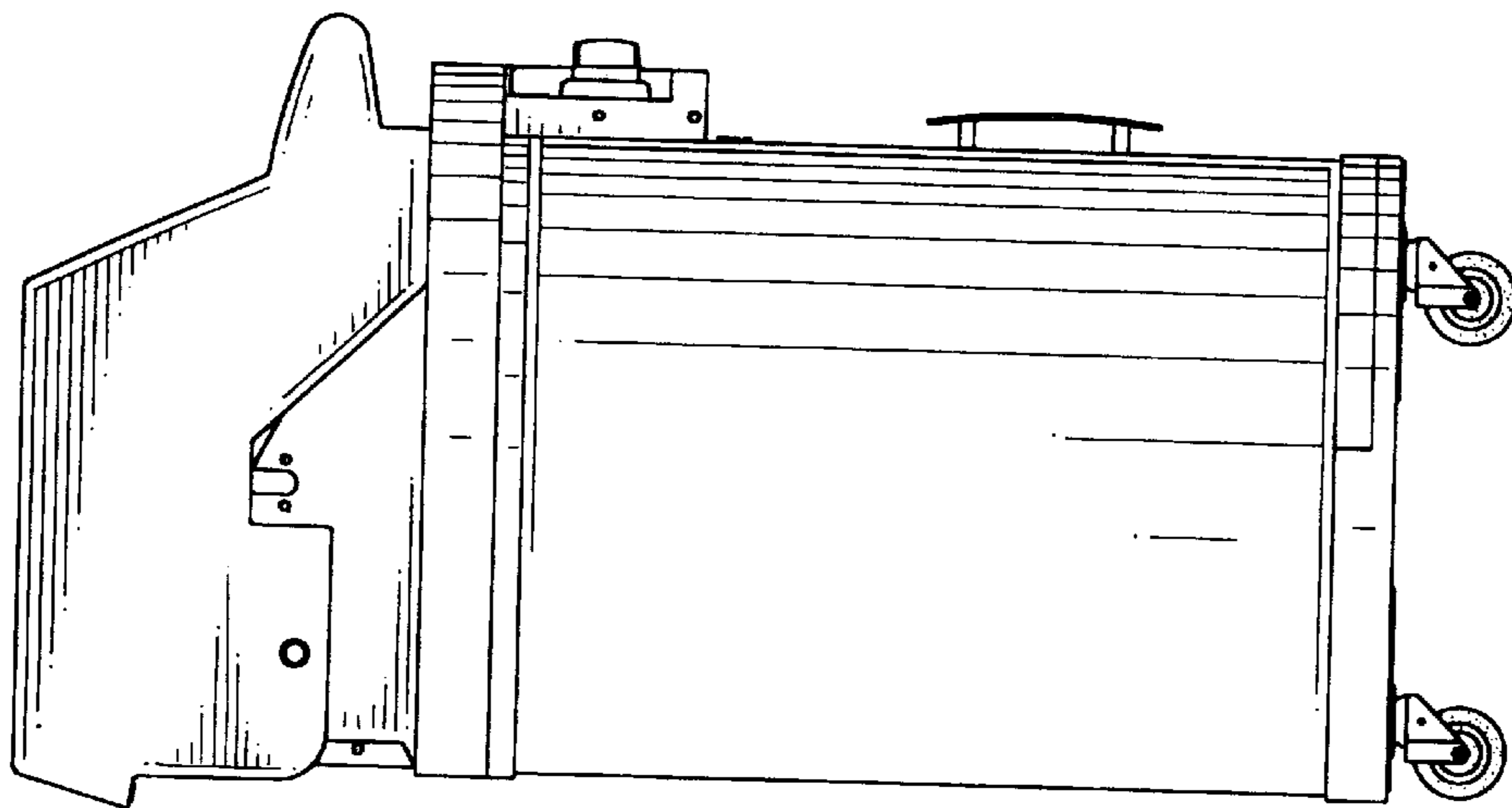

FIG.4

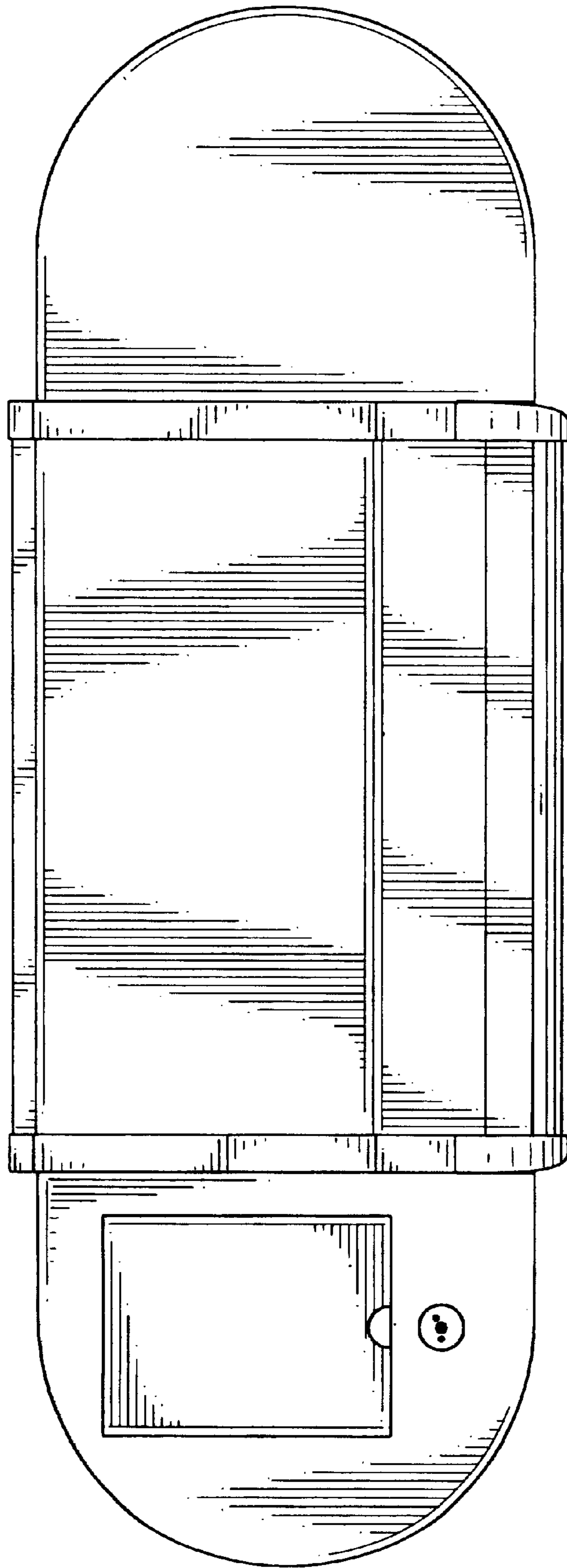

FIG.6

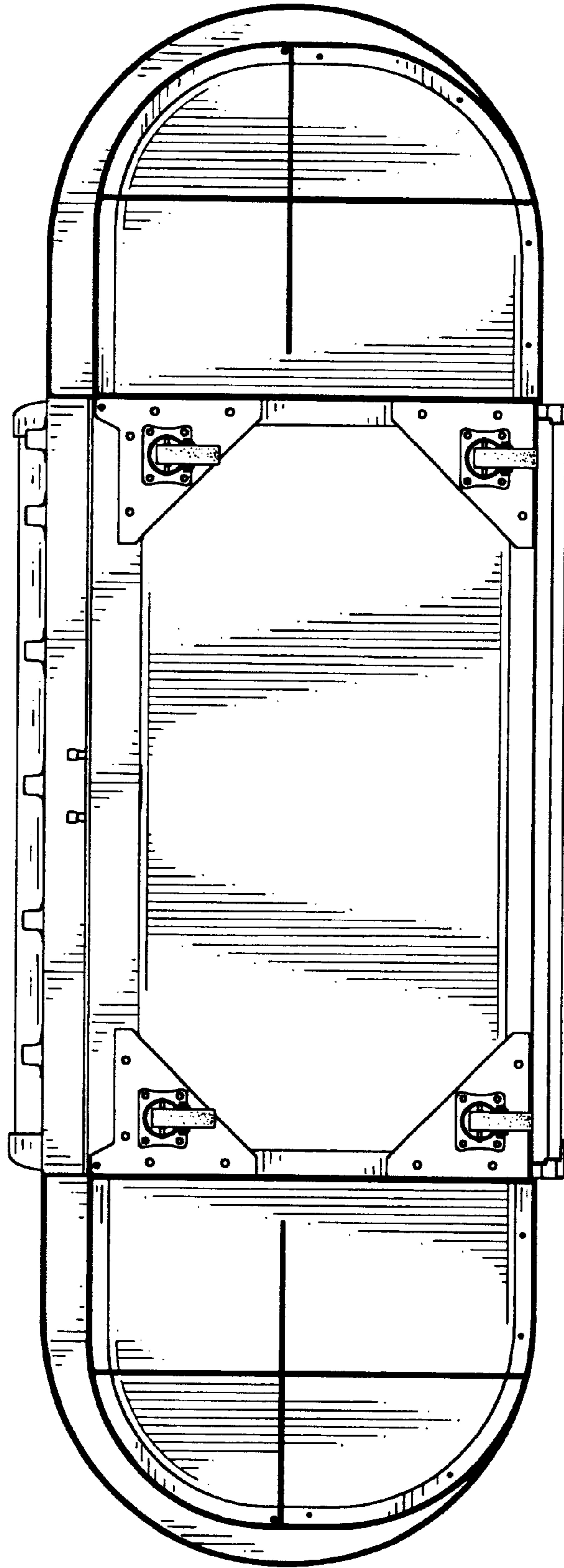

FIG.7