



US00D489214S

(12) **United States Design Patent**  
Noda et al.

(10) Patent No.: **US D489,214 S**

(45) Date of Patent: **\*\* May 4, 2004**

(54) **COFFEE MAKER**

(75) Inventors: **Kensaku Noda**, Otsu (JP); **Hiroki Takase**, Kyoto (JP); **Kenji Kaneko**, Ashiya (JP)

(73) Assignee: **Sanyo Electric Co., Ltd.**, Osaka-Fu (JP)

(\*\*) Term: **14 Years**

(21) Appl. No.: **29/165,809**

(22) Filed: **Aug. 15, 2002**

(30) **Foreign Application Priority Data**

Feb. 15, 2002 (JP) ..... 2002-003699

(51) **LOC (7) Cl.** ..... **07-01**

(52) **U.S. Cl.** ..... **D7/309; D7/310; D7/311**

(58) **Field of Search** ..... **D7/309, 310, 311, D7/307, 305, 306, 300; 99/280, 293, 284, 279, 295, 307; 392/467; 219/526, 536; D15/82**

(56) **References Cited**

**U.S. PATENT DOCUMENTS**

D207,526 S	*	4/1967	Martin	.....	D7/311
D218,191 S	*	7/1970	Tevolitz	.....	D7/309
3,592,125 A	*	7/1971	Tolmie et al.	.....	99/307
D240,386 S	*	7/1976	Stuetzer	.....	D7/309
4,721,034 A	*	1/1988	Shimomura	.....	99/280
D300,596 S	*	4/1989	Eugster	.....	D7/309

D307,754 S	*	5/1990	Osrow et al.	.....	D15/82
D331,522 S	*	12/1992	Littmann	.....	D7/309
D339,953 S	*	10/1993	Bunn et al.	.....	D7/309
D369,268 S	*	4/1996	Assmann et al.	.....	D7/309
D401,108 S	*	11/1998	Pochopien et al.	.....	D7/309
D401,803 S	*	12/1998	Alferink	.....	D7/307
D404,604 S	*	1/1999	Pochopien et al.	.....	D7/309
D424,360 S	*	5/2000	Schwarz et al.	.....	D7/309
D432,848 S	*	10/2000	Brady et al.	.....	D7/309
D432,849 S	*	10/2000	Brady et al.	.....	D7/309
D451,329 S	*	12/2001	DeMars	.....	D7/305
D454,466 S	*	3/2002	Hong	.....	D7/309
D472,754 S	*	4/2003	Long et al.	.....	D7/309

\* cited by examiner

*Primary Examiner*—M. N. Pandozzi  
(74) *Attorney, Agent, or Firm*—Darby & Darby

(57) **CLAIM**

We claim the novel design for a coffee maker, as shown.

**DESCRIPTION**

FIG. 1 is a perspective view of our new design for a coffee maker;  
FIG. 2 is a top plan view thereof;  
FIG. 3 is a bottom plan view thereof;  
FIG. 4 is a front view thereof;  
FIG. 5 is a rear view thereof;  
FIG. 6 is a right side view thereof; and,  
FIG. 7 is a perspective view thereof in an alternate position with a cap opening of a camber part.

**1 Claim, 5 Drawing Sheets**

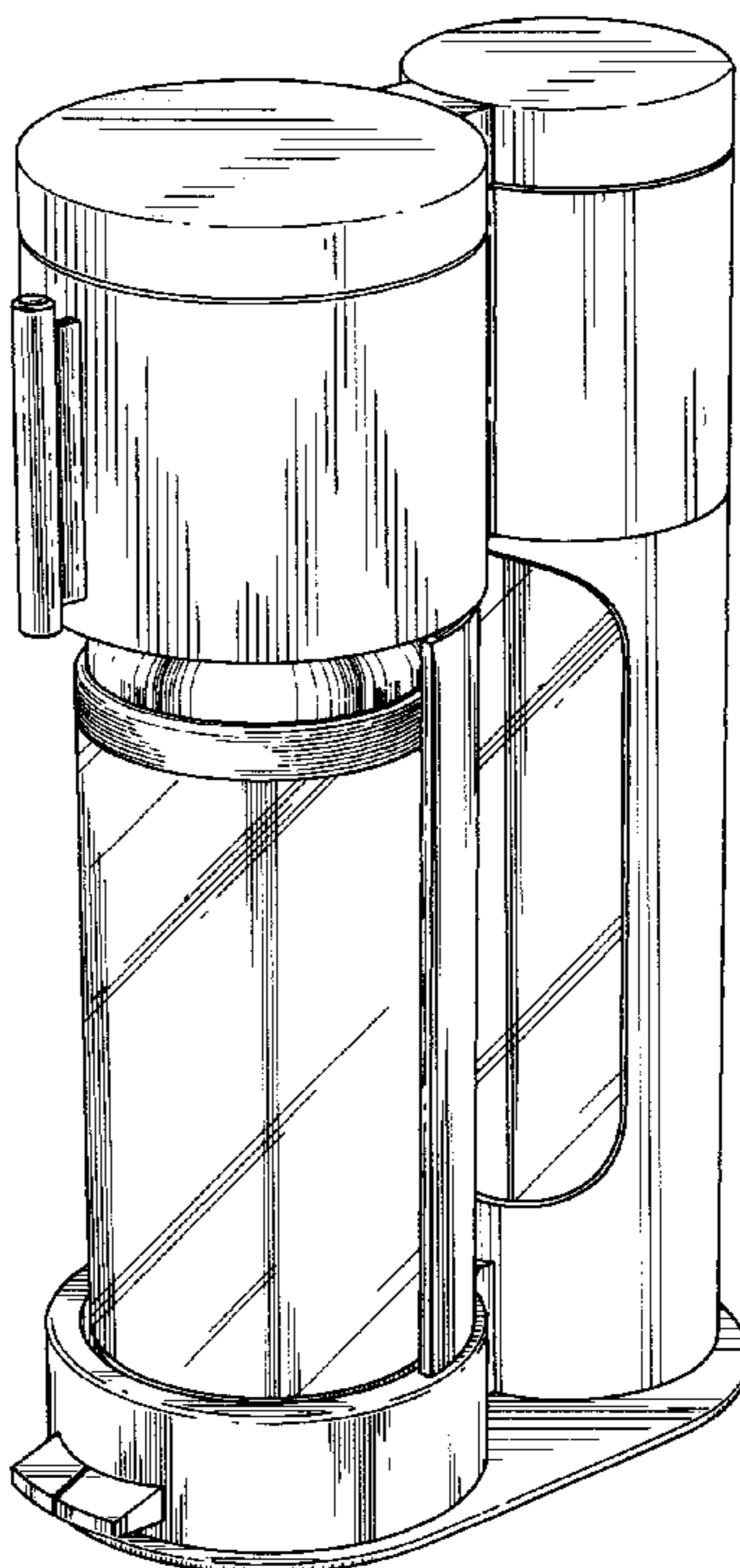

FIG. 1

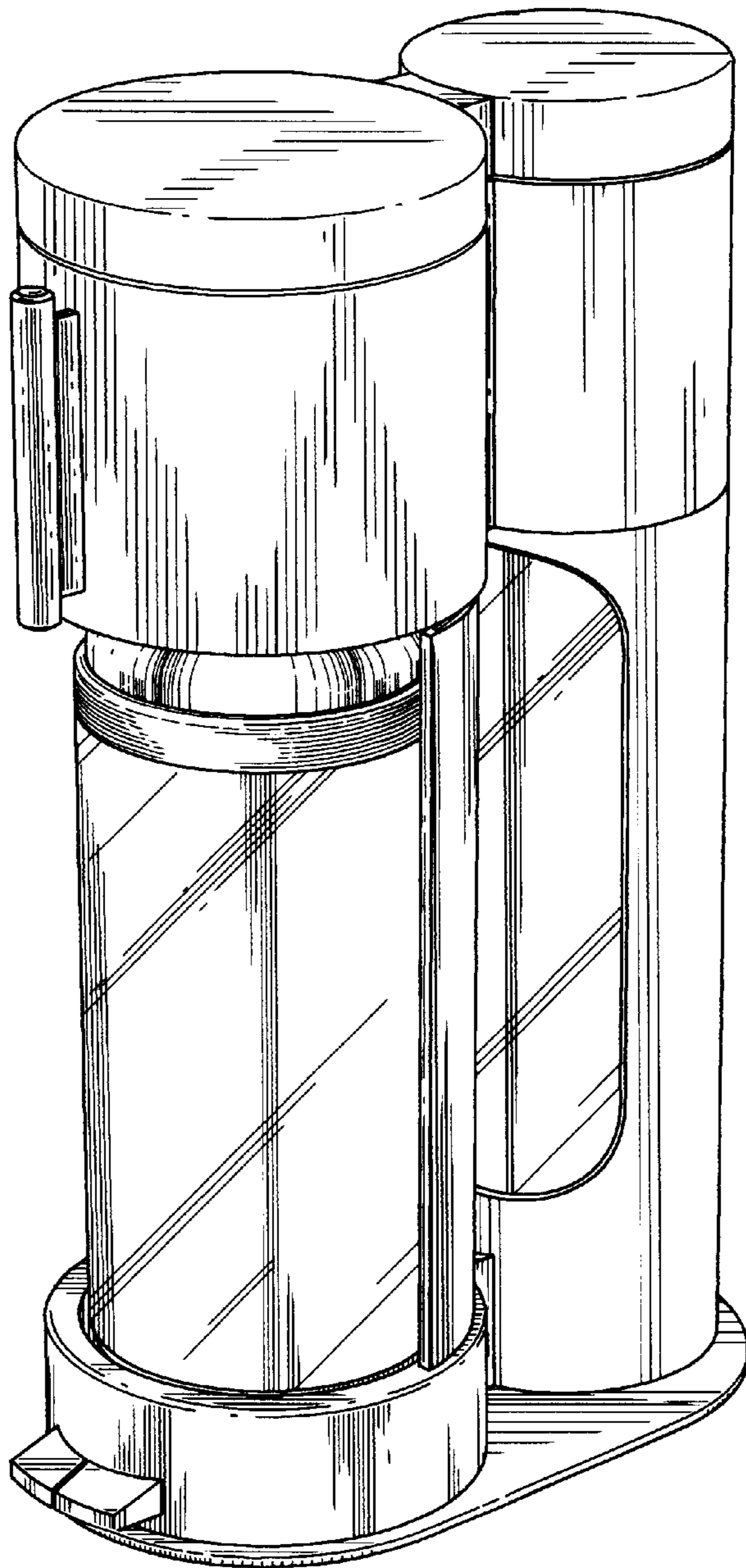

FIG. 2

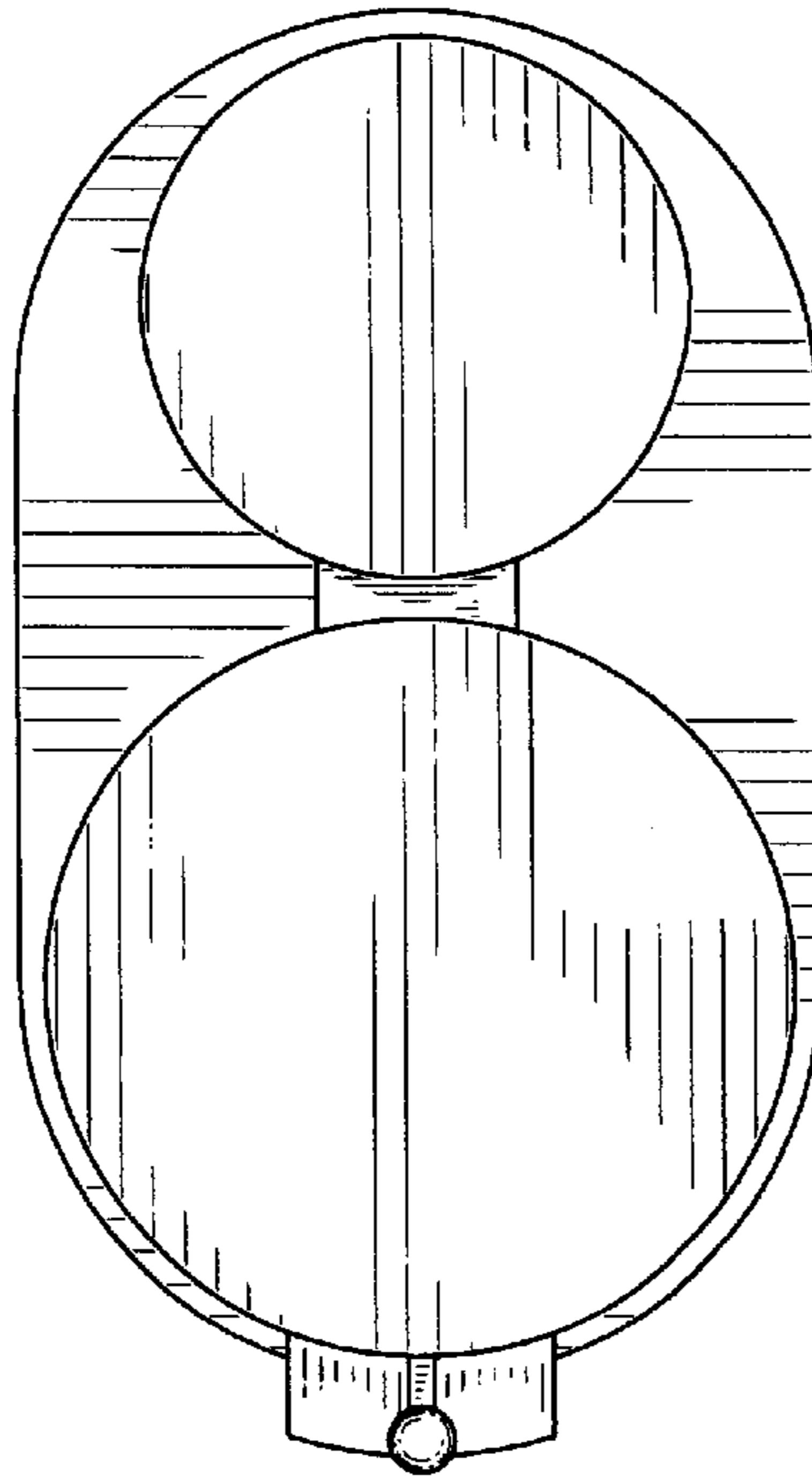

FIG. 3

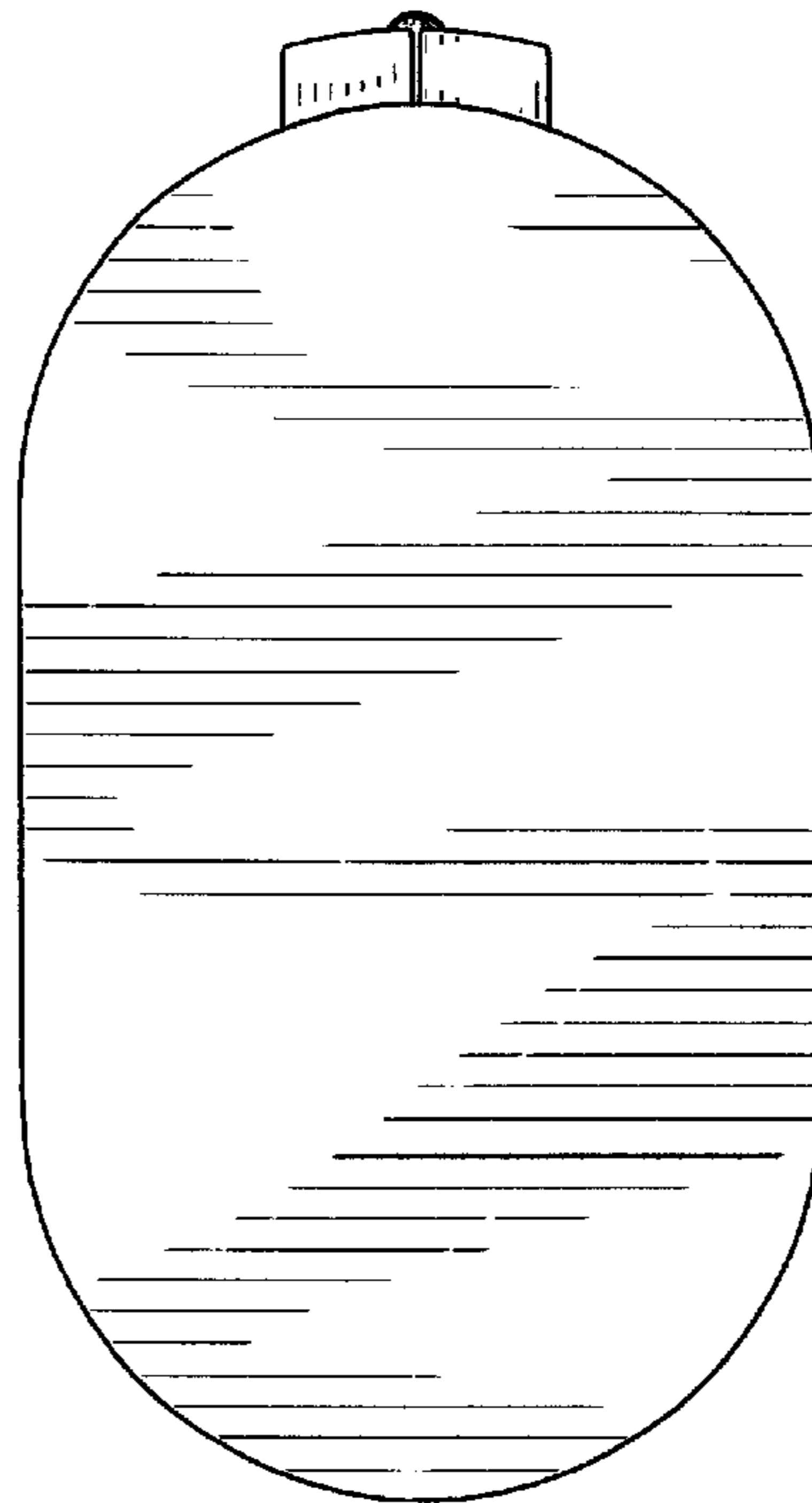

FIG. 4

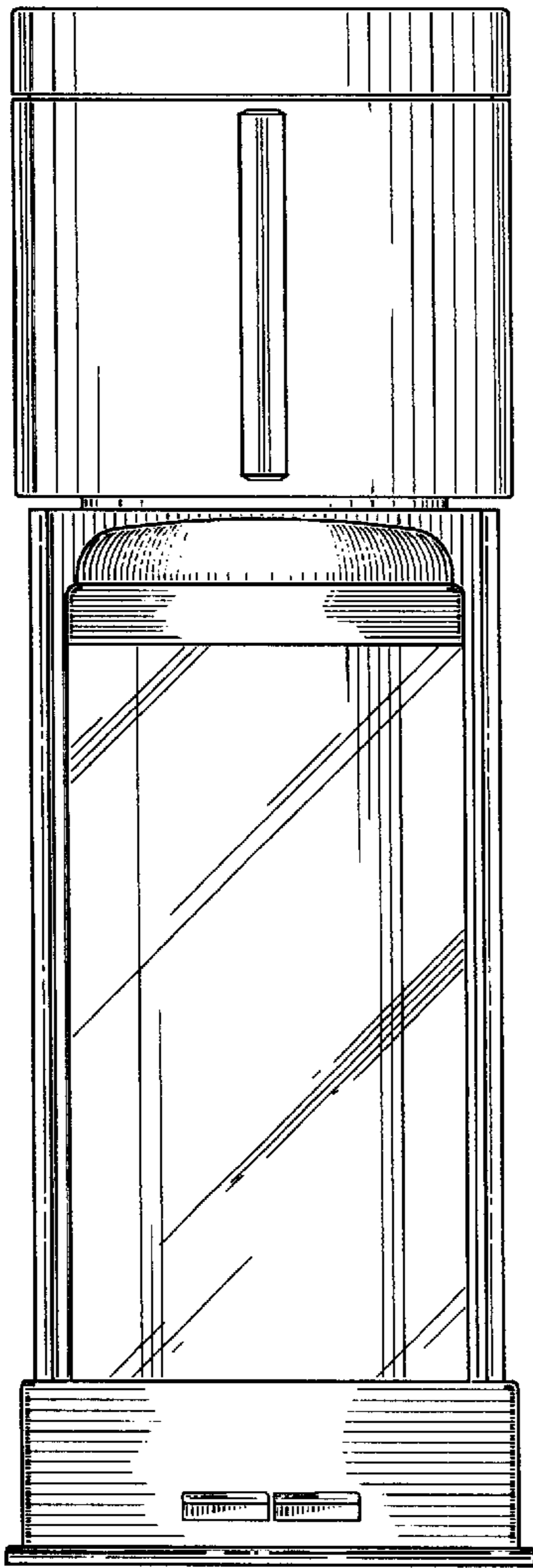

FIG. 5

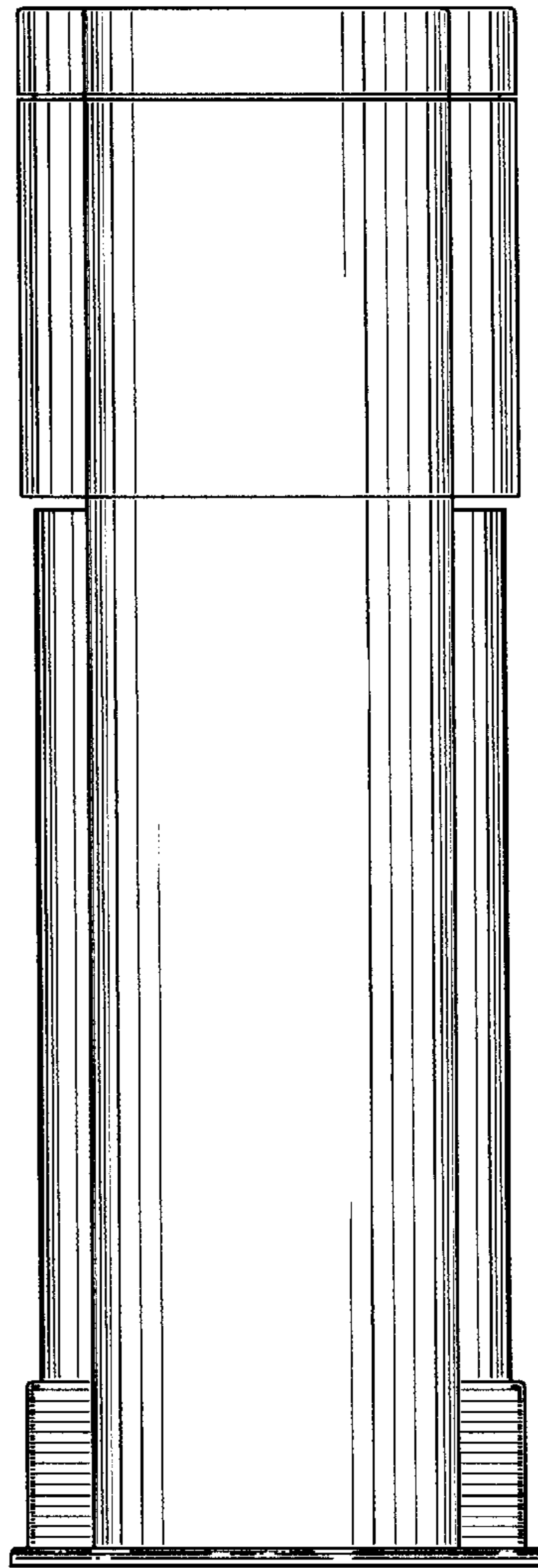

FIG. 6

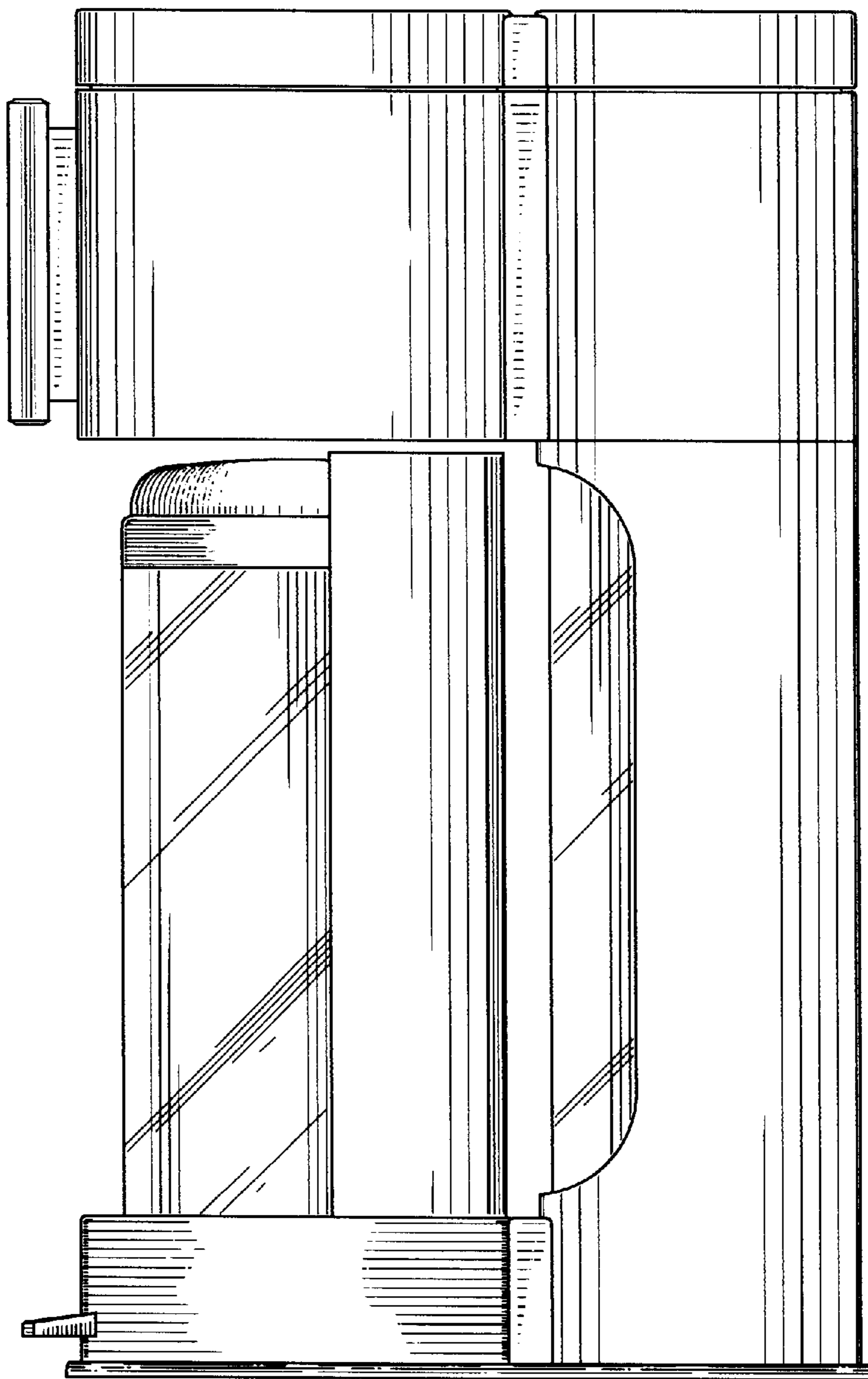

FIG. 7

