



US00D489156S

(12) **United States Design Patent**  
**Liu**

(10) **Patent No.:** **US D489,156 S**

(45) **Date of Patent:** **\*\* Apr. 27, 2004**

(54) **HANDLE OF A GOLF CART**

*Primary Examiner*—Kay H. Chin

(76) **Inventor:** **Chong-Yong Liu**, 58, Ma Yuan West St., Taichung (TW)

(57) **CLAIM**

(\*\*) **Term:** **14 Years**

The ornamental design for a handle of a golf cart, as shown and described.

(21) **Appl. No.:** **29/161,808**

**DESCRIPTION**

(22) **Filed:** **May 30, 2002**

FIG. 1 is a perspective view of a handle of a golf cart showing my design;

(51) **LOC (7) Cl.** ..... **12-02**

FIG. 2 is a front elevational view thereof;

(52) **U.S. Cl.** ..... **D34/27**

FIG. 3 is a rear elevational view thereof;

(58) **Field of Search** ..... D34/12-27; 280/DIG. 5, 280/DIG. 6, 641, 646, 655; 180/19.1, 19.3, 215, 216, 907

FIG. 4 is a left side elevational view thereof;

FIG. 5 is a right side elevational view thereof;

FIG. 6 is a top plan view thereof;

FIG. 7 is a bottom plan view thereof;

(56) **References Cited**

FIG. 8 is a perspective schematic view illustrating a handle showing my design is disposed on a golf cart; and,

**U.S. PATENT DOCUMENTS**

FIG. 9 is a perspective view illustrating a golf cart showing my design is folded.

D450,416 S	*	11/2001	Liao	.....	D34/15
D454,417 S	*	3/2002	Wu	.....	D34/15
D454,996 S	*	3/2002	Liao	.....	D34/15
D462,152 S	*	8/2002	Liao	.....	D34/15
D468,511 S	*	1/2003	Liu	.....	D34/15

The broken line disclosure of the golf cart is for illustrative purposes only and forms no part of the claimed design.

\* cited by examiner

**1 Claim, 8 Drawing Sheets**

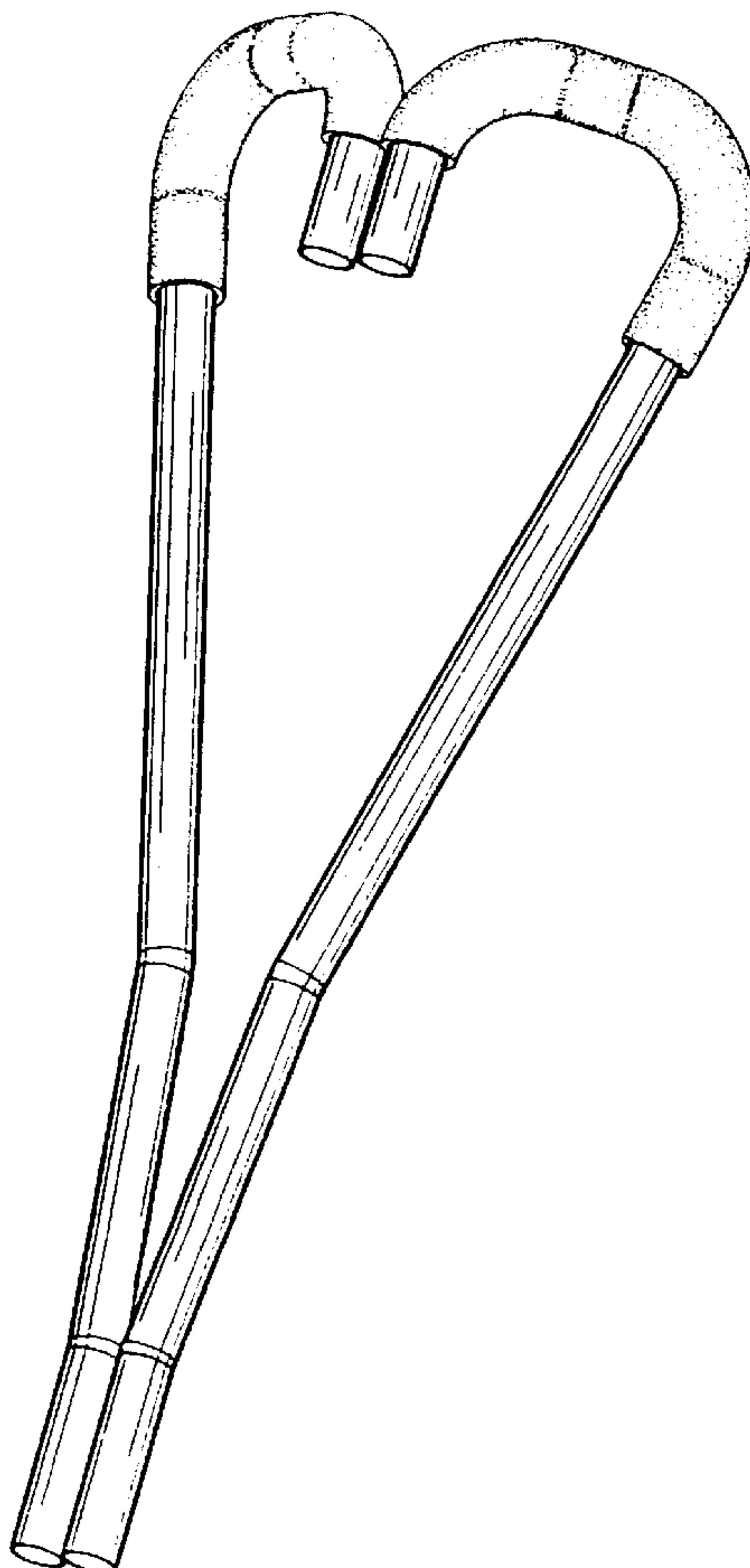

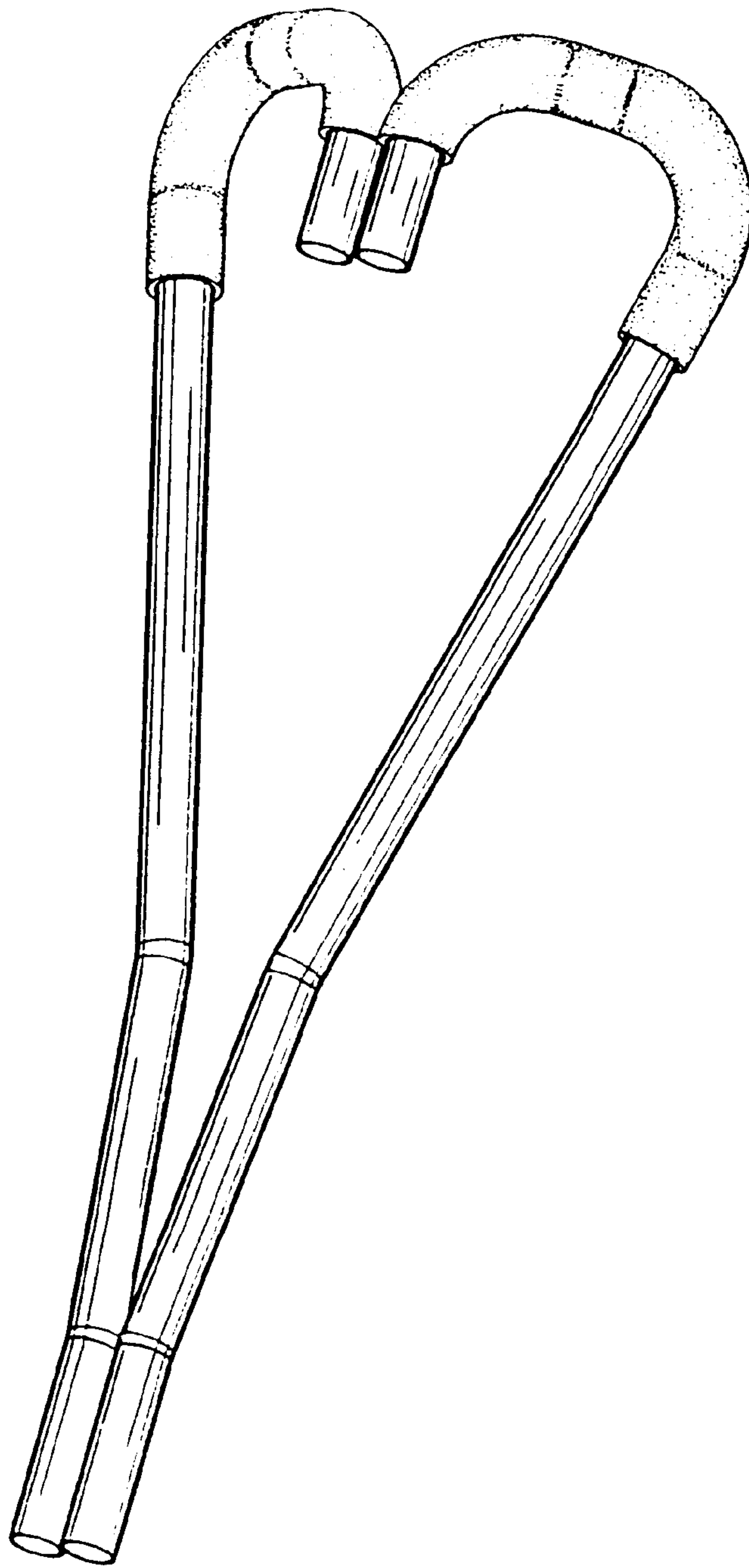

FIG.1

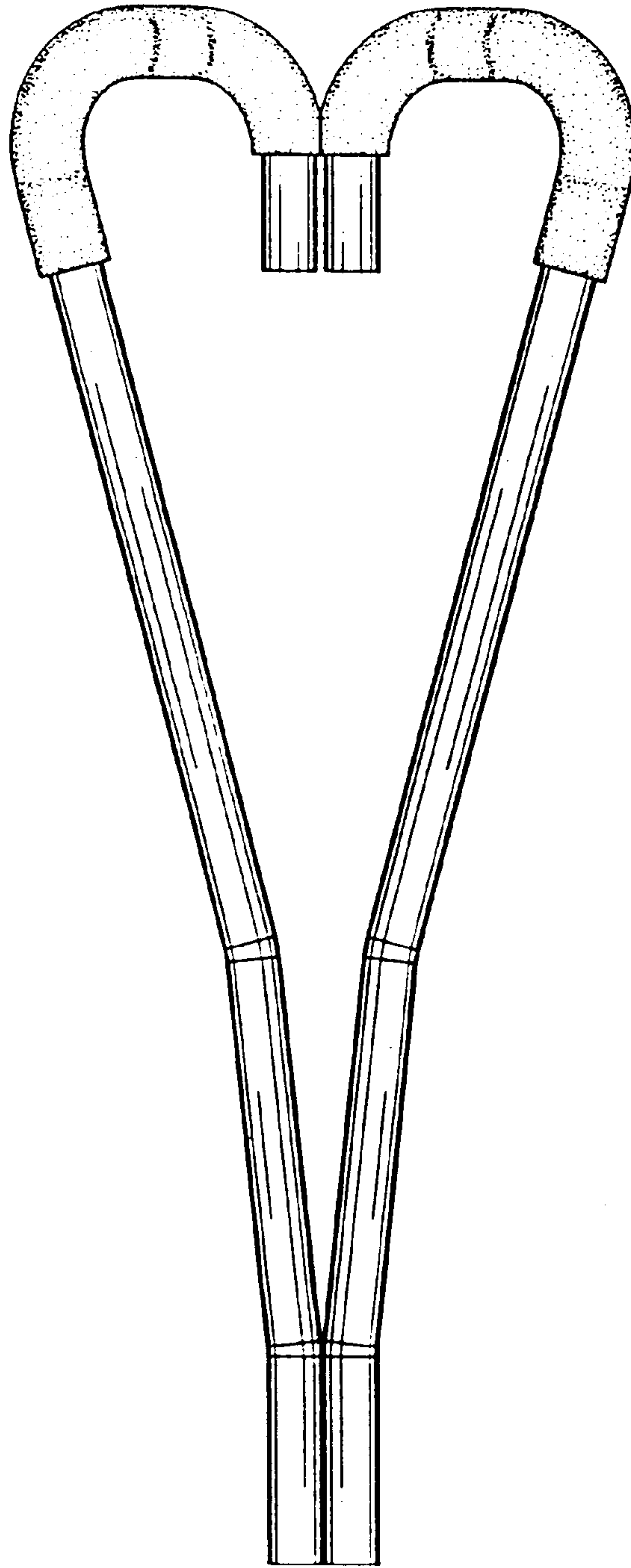

FIG.2

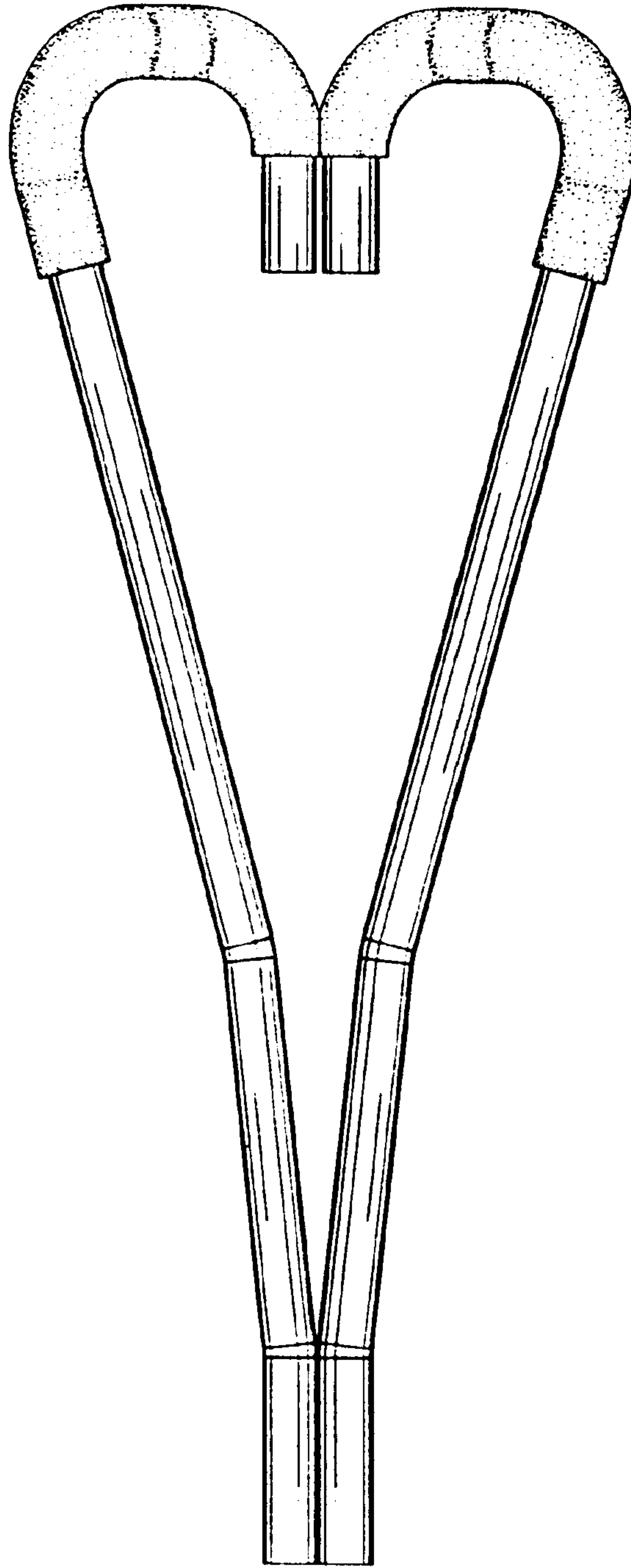

FIG.3

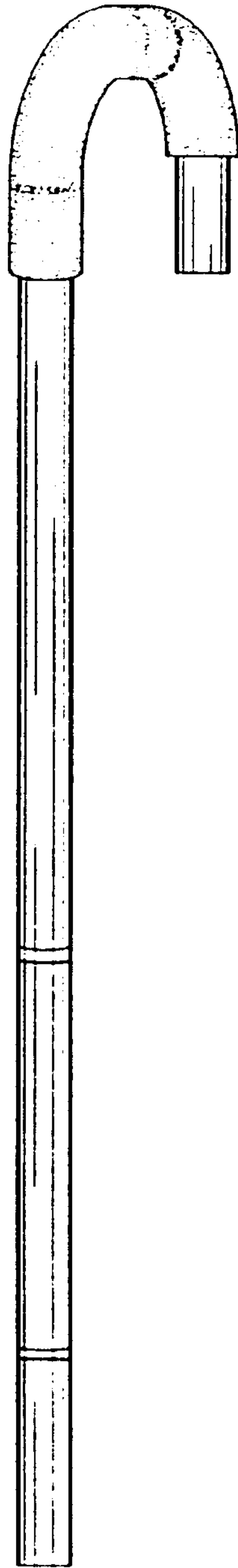

FIG.4

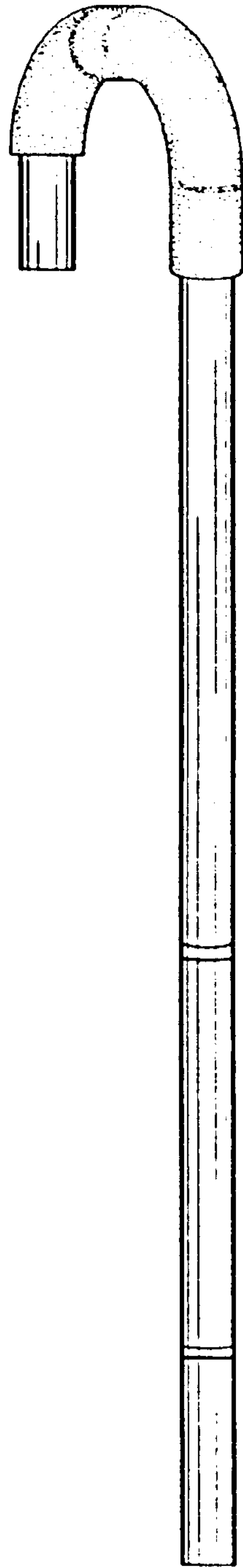

FIG. 5

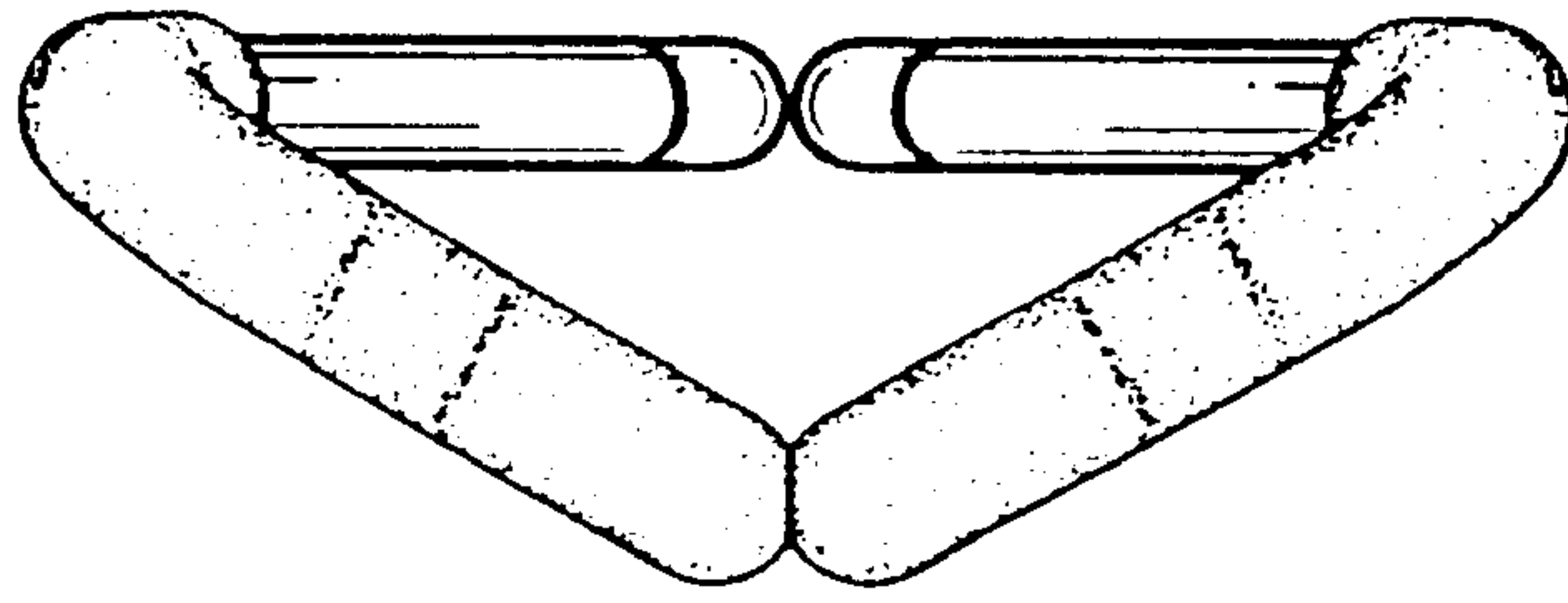

FIG. 6

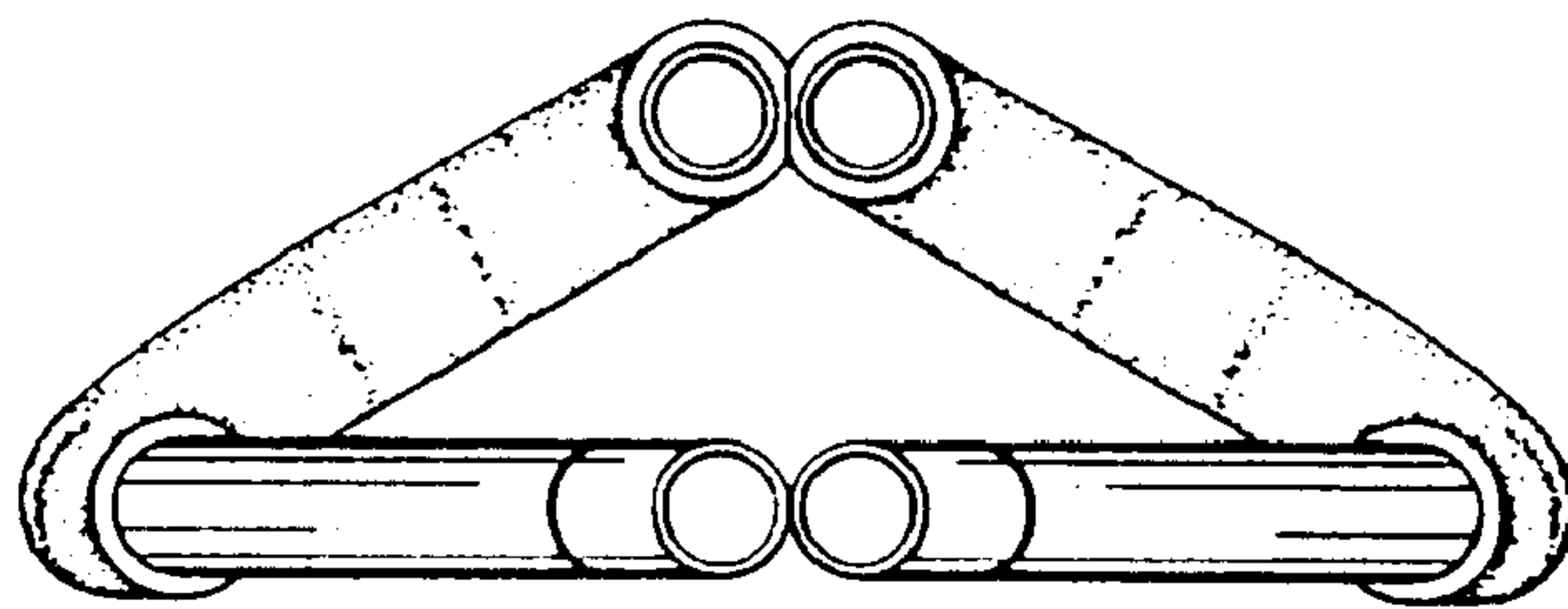

FIG. 7



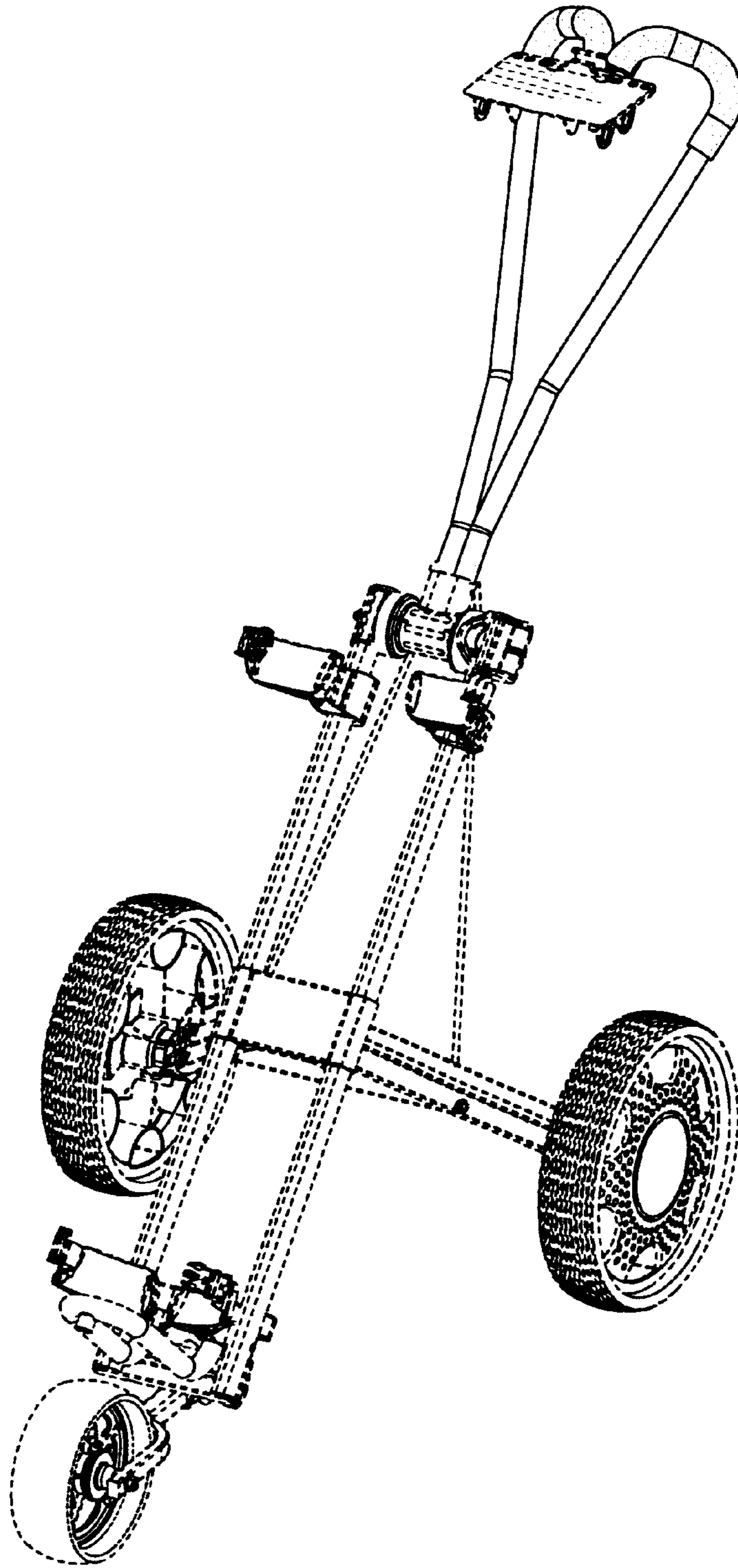

FIG.8



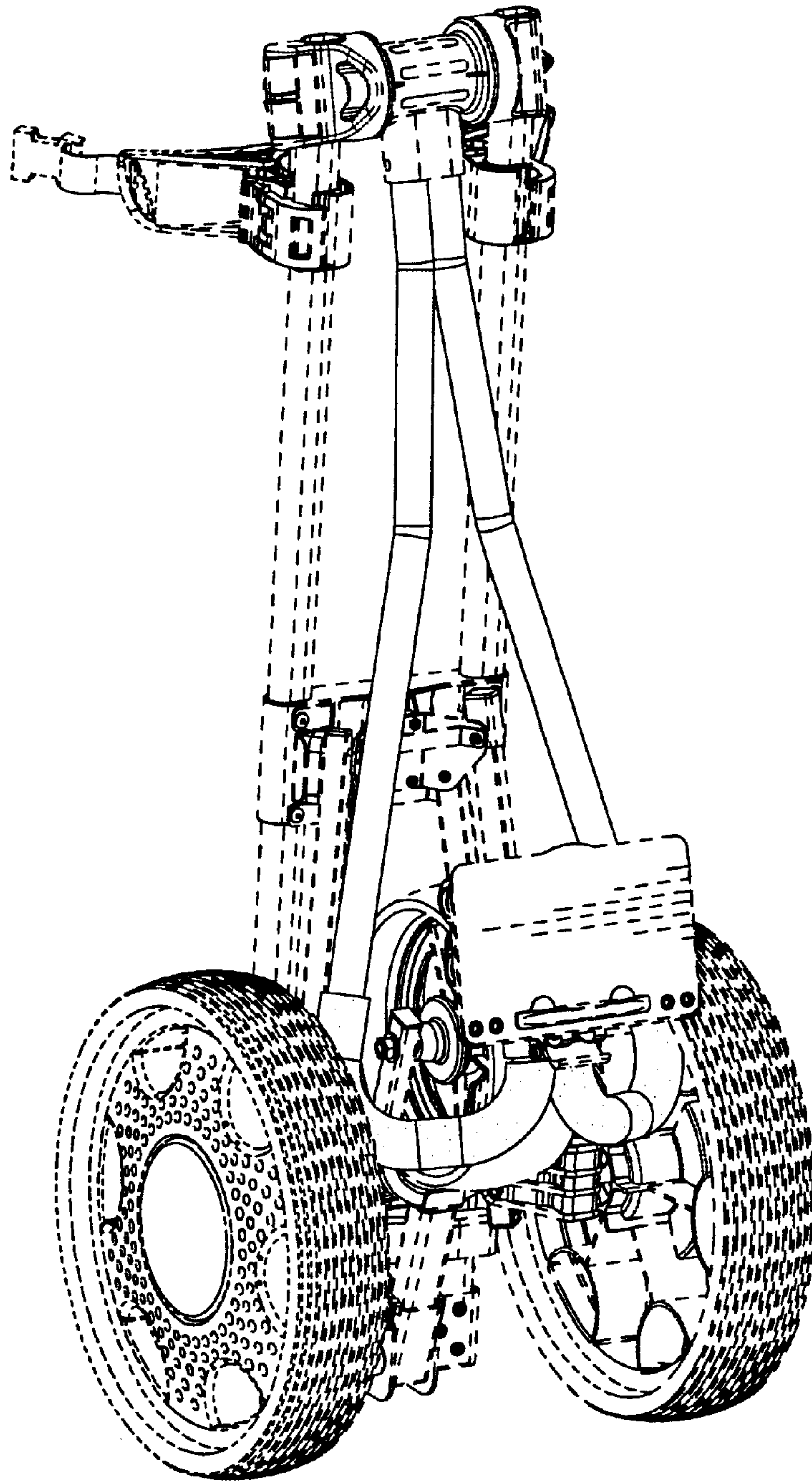

FIG.9