



US00D489102S

(12) **United States Design Patent**
Chen

(10) **Patent No.:** **US D489,102 S**

(45) **Date of Patent:** **** Apr. 27, 2004**

(54) **DUMBBELL**

(76) **Inventor:** **Jui Tseng Chen**, 4F, No. 38, Alley 7,
Lane 100, Duen Hua South Road,
Section 1, Taipei 106 (TW)

(**) **Term:** **14 Years**

(21) **Appl. No.:** **29/179,467**

(22) **Filed:** **Apr. 11, 2003**

(51) **LOC (7) Cl.** **21-02**

(52) **U.S. Cl.** **D21/681**

(58) **Field of Search** D21/662, 679,
D21/680, 681, 682, 683, 684; 482/105,
106, 107, 108, 109

(56) **References Cited**

U.S. PATENT DOCUMENTS

3,334,899	A	*	8/1967	Bosko et al.	482/108
4,361,324	A	*	11/1982	Baroi	482/108
D279,495	S	*	7/1985	Barbeau	D21/681
D297,751	S	*	9/1988	Brown	D21/681
D326,299	S	*	5/1992	King et al.	D21/681
D339,839	S	*	9/1993	Day	D21/678

5,250,014	A	*	10/1993	Chang	482/106
5,445,587	A	*	8/1995	Brown	482/108
D380,511	S	*	7/1997	Anthony, Jr.	D21/681
D415,803	S	*	10/1999	Cousins	D21/681
D418,881	S	*	1/2000	Cousins	D21/681
D444,516	S	*	7/2001	Pearson et al.	D21/681

* cited by examiner

Primary Examiner—Philip S. Hyder

(74) *Attorney, Agent, or Firm*—Rosenberg, Klein & Lee

(57) **CLAIM**

The ornamental design for a dumbbell, as shown and described.

DESCRIPTION

FIG. 1 is a perspective view of a dumbbell in accordance with the design;
FIG. 2 is a front elevational view thereof;
FIG. 3 is a rear elevational view thereof;
FIG. 4 is a left side elevational view thereof;
FIG. 5 is a right side elevational view thereof;
FIG. 6 is a top plan view thereof; and,
FIG. 7 is a bottom plan view thereof.

1 Claim, 4 Drawing Sheets

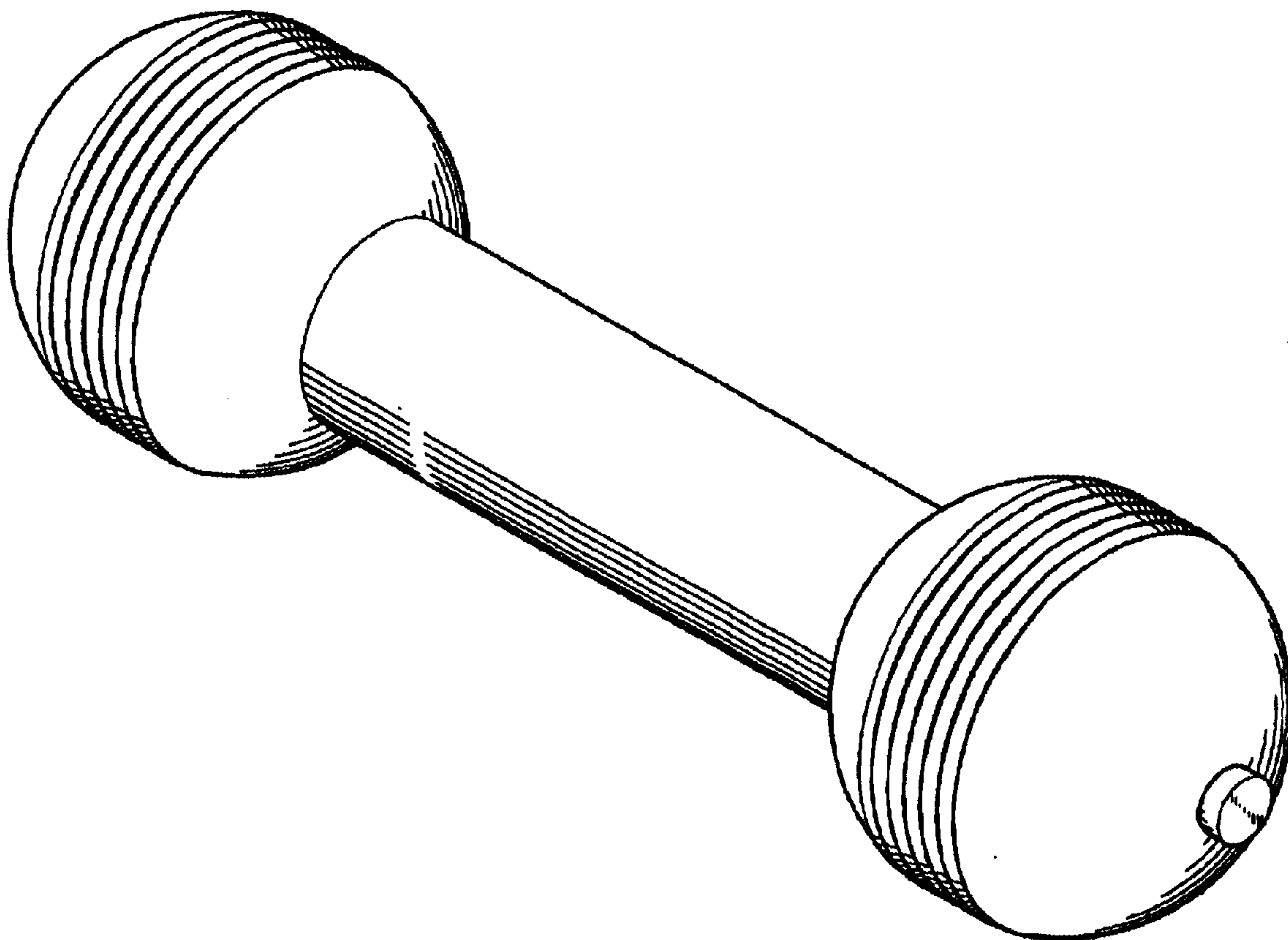

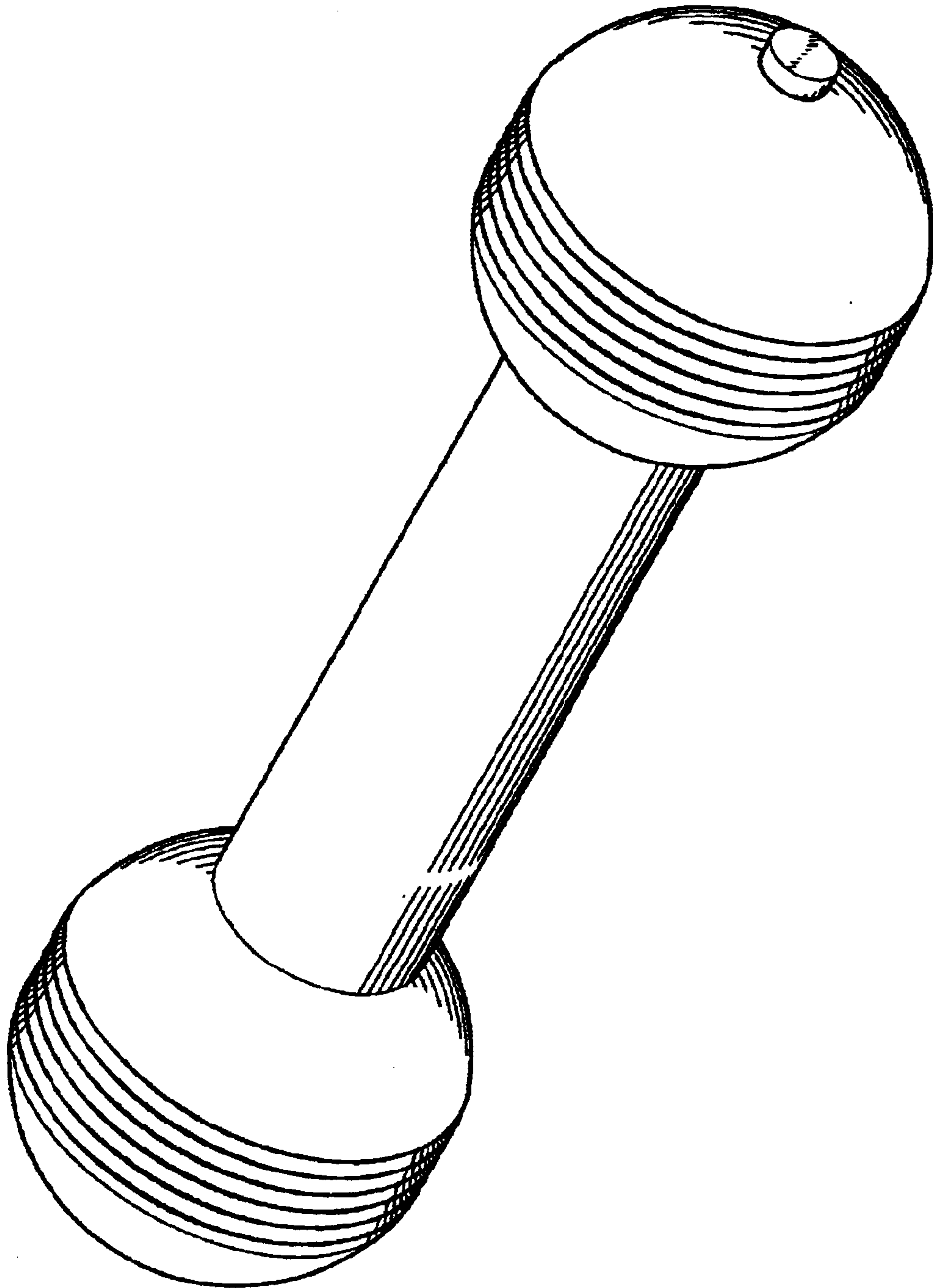

FIG. 1

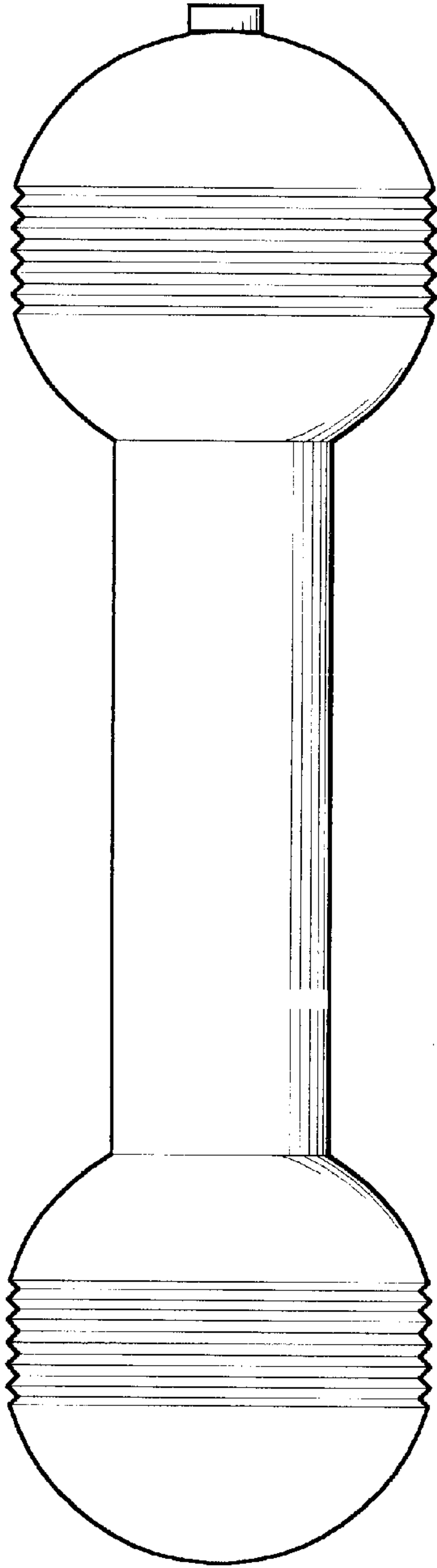

FIG. 2

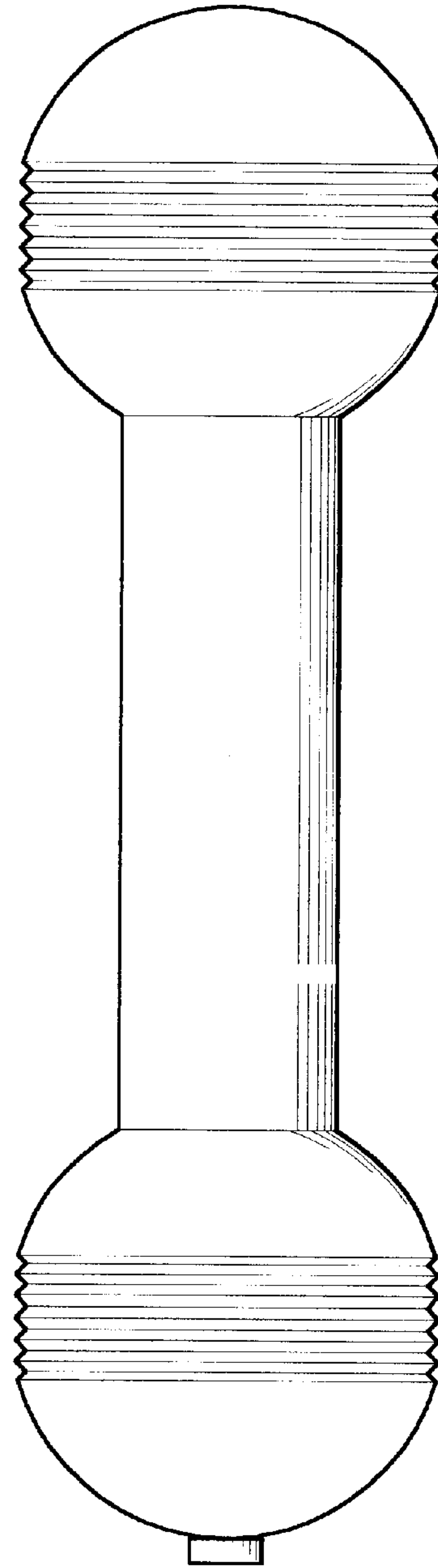

FIG. 3

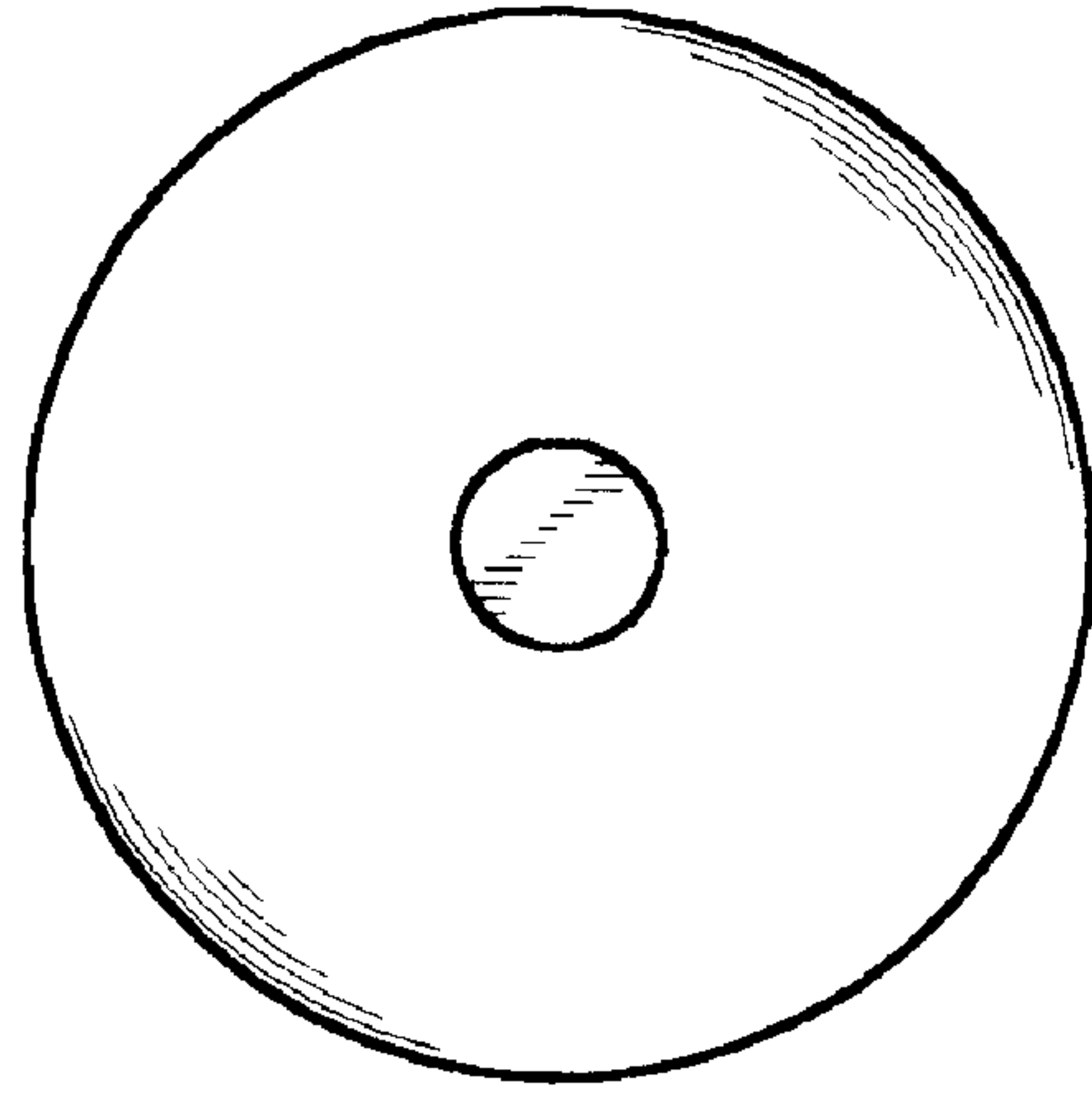

FIG. 5

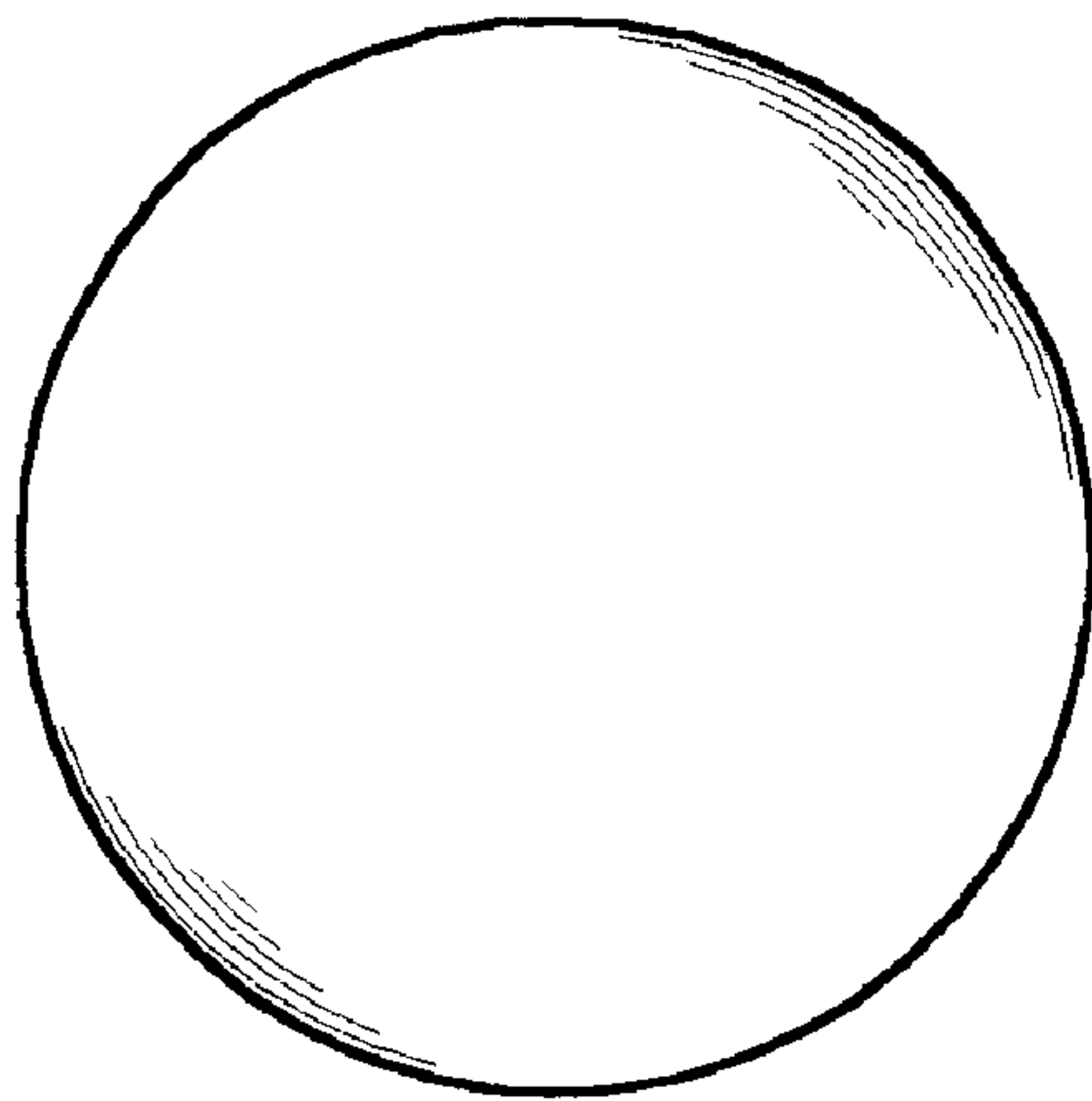

FIG. 4

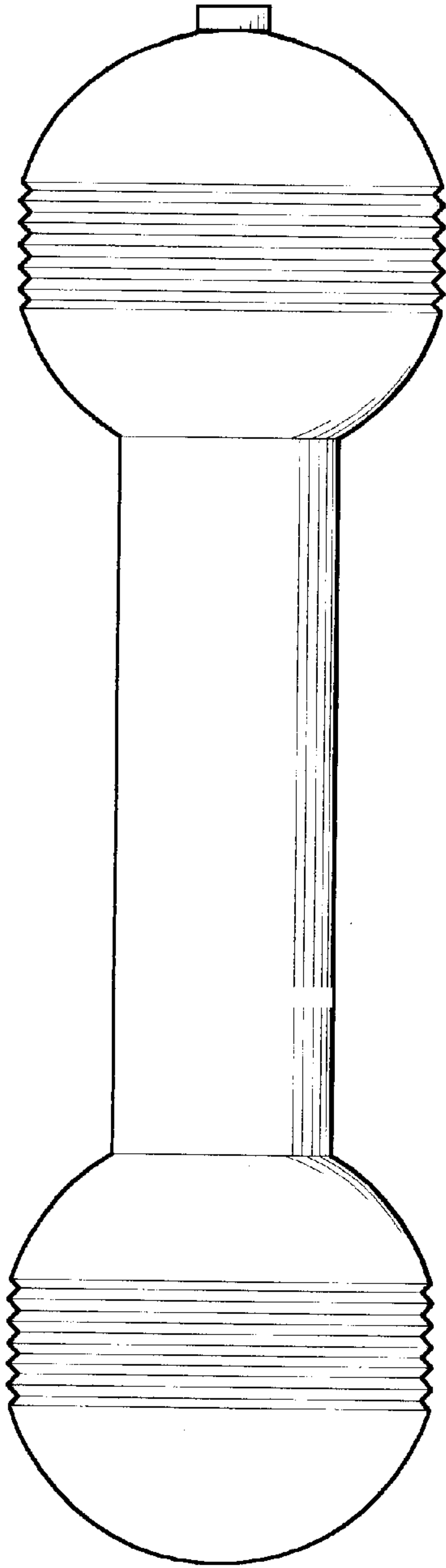

FIG. 6

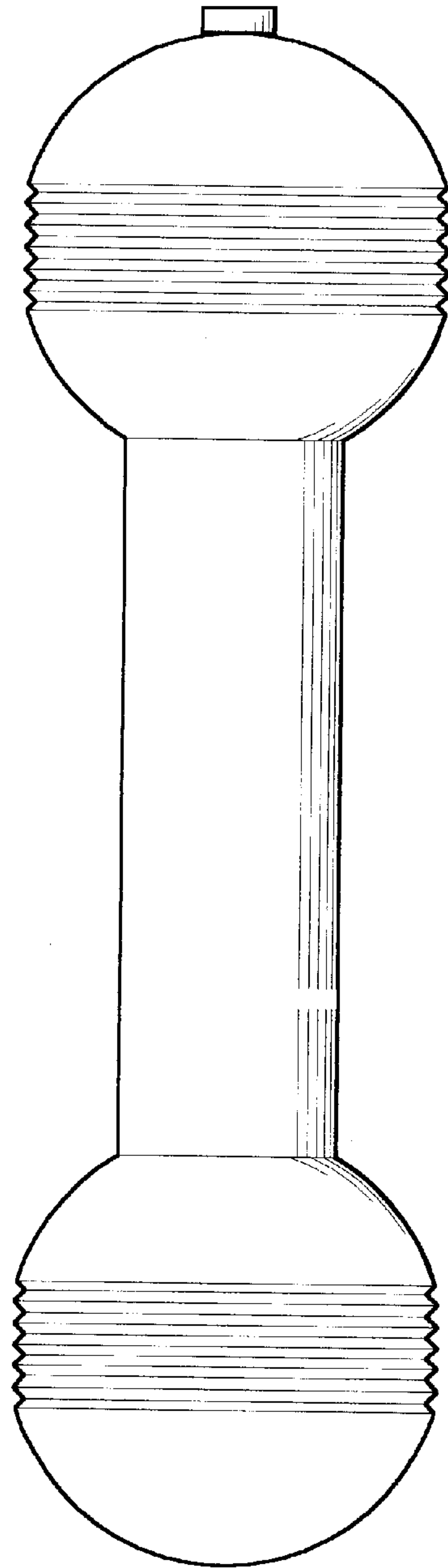

FIG. 7