



US00D489087S

(12) **United States Design Patent**
Kent

(10) **Patent No.:** **US D489,087 S**

(45) **Date of Patent:** **** Apr. 27, 2004**

(54) **WRITING INSTRUMENT**

DESCRIPTION

(75) Inventor: **Michael Kent**, Cheshire, CT (US)

(73) Assignee: **Bic Corporation**, Milford, CT (US)

(**) Term: **14 Years**

(21) Appl. No.: **29/179,584**

(22) Filed: **Apr. 11, 2003**

(51) **LOC (7) Cl.** **19-06**

(52) **U.S. Cl.** **D19/43; D19/51; D19/56**

(58) **Field of Search** **D19/35, 36, 41-51,**
D19/53-58, 81-85; 401/6, 7, 88, 98, 202,
213, 243-247, 262

(56) **References Cited**

U.S. PATENT DOCUMENTS

D82,309 S	*	10/1930	Bloser	D19/43
D395,448 S	*	6/1998	Chevalier	D19/51
D409,661 S	*	5/1999	Izushima	D19/57
D423,576 S	*	4/2000	Stevens et al.	D19/43
D431,598 S	*	10/2000	Kim et al.	D19/36
D441,793 S	*	5/2001	Takemura	D19/51
D446,213 S	*	8/2001	Chen et al.	D14/411
D456,842 S	*	5/2002	Ono	D19/36
D472,922 S	*	4/2003	Stropkay et al.	D19/43

OTHER PUBLICATIONS

BIC Stationary Products Catalog 2002/2003, p. 12. & photograph showing side elevational view (first sold Feb. 3, 2001).

* cited by examiner

Primary Examiner—Martie K. Holtje

(74) *Attorney, Agent, or Firm*—Pennie & Edmonds LLP

(57) **CLAIM**

The ornamental design for a writing instrument, as shown and described.

FIG. 1 is a front, right, and top perspective view of an ornamental design for a writing instrument according to the present invention;

FIG. 2 is a front elevational view thereof;

FIG. 3 is a rear elevational view thereof;

FIG. 4 is a left side elevational view thereof, the right side elevational view being a mirror image thereof;

FIG. 5 is a top plan view thereof;

FIG. 6 is a bottom plan view thereof;

FIG. 7 is a perspective view of a writing instrument as in FIG. 1 in an exemplary use position;

FIG. 8 is a front, right, and top perspective view of an ornamental design for a translucent writing instrument according to the present invention;

FIG. 9 is a front elevational view thereof;

FIG. 10 is a rear elevational view thereof;

FIG. 11 is a left side elevational view thereof, the right side elevational view being a mirror image thereof;

FIG. 12 is a top plan view thereof;

FIG. 13 is a bottom plan view thereof; and

FIG. 14 is a perspective view of a writing instrument as in FIG. 8 in an exemplary use position.

FIG. 15 is a front, right, and top perspective view of an ornamental design for a second embodiment of a translucent writing instrument according to the present invention;

FIG. 16 is a front elevational view thereof;

FIG. 17 is a rear elevational view thereof;

FIG. 18 is a left side elevational view thereof, the right side elevational view being a mirror image thereof;

FIG. 19 is a top plan view thereof;

FIG. 20 is a bottom plan view thereof; and,

FIG. 21 is a perspective view of a writing instrument as in FIG. 15 in an exemplary use position.

All portions shown in broken lines are environmental and illustrative only and form no part of the claimed design.

1 Claim, 18 Drawing Sheets

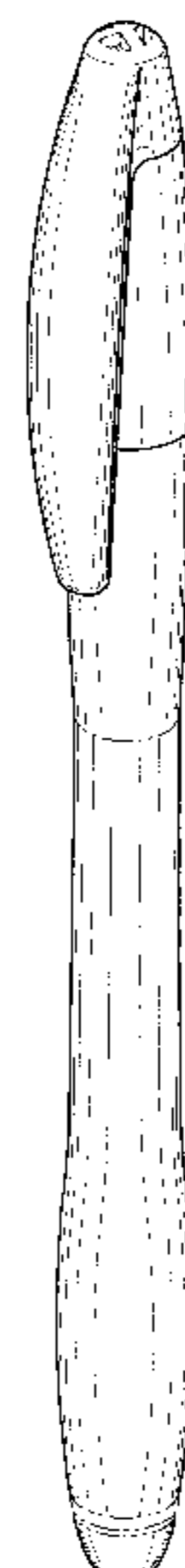

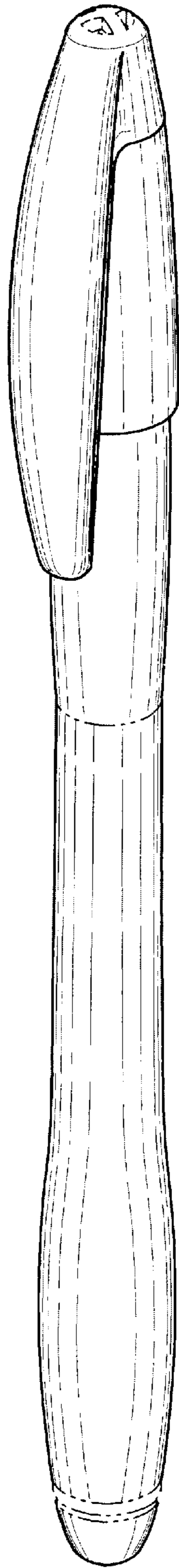

Fig. 1

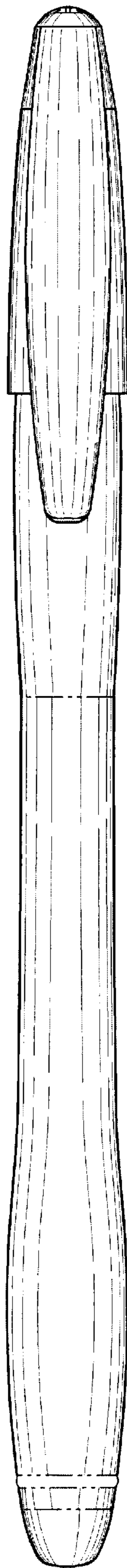

Fig. 2

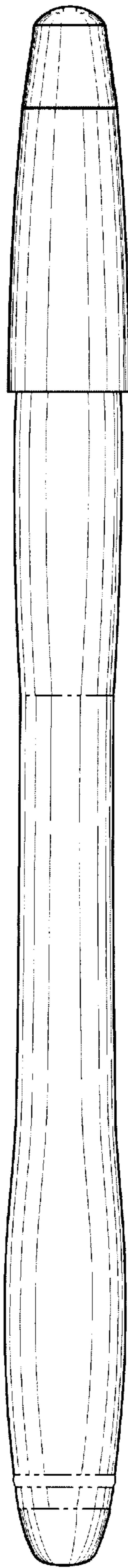

Fig. 3

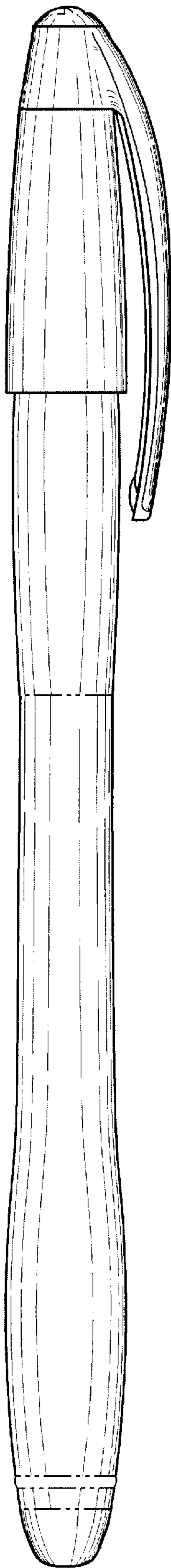

Fig. 4

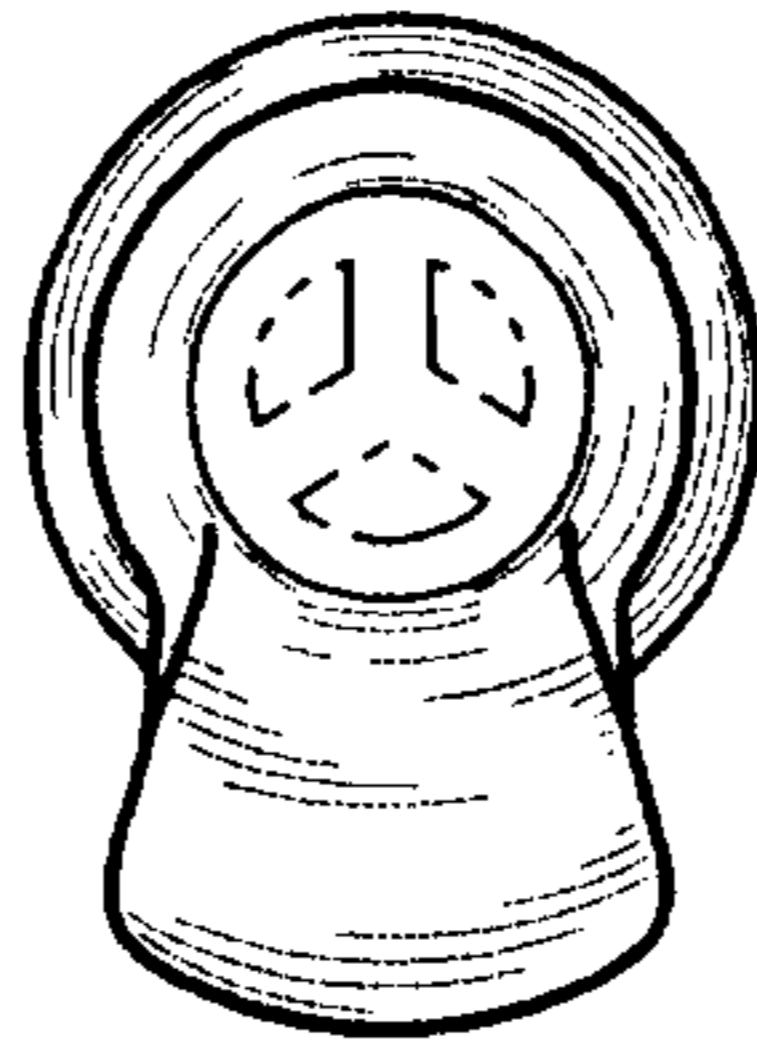

Fig. 5

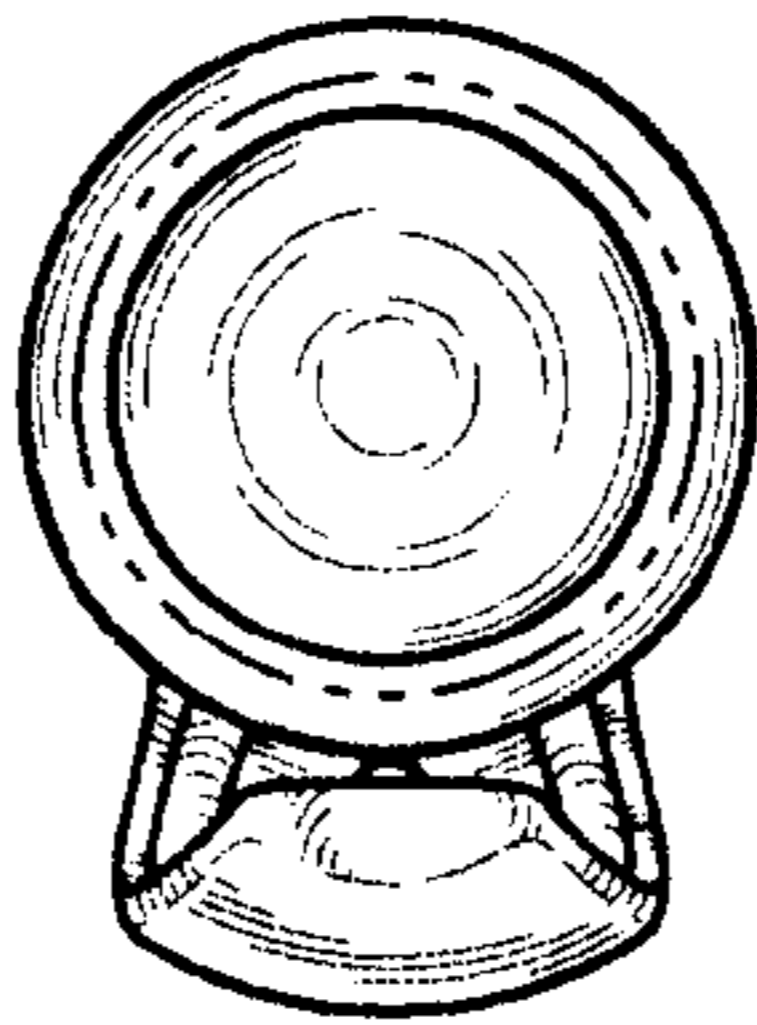

Fig. 6

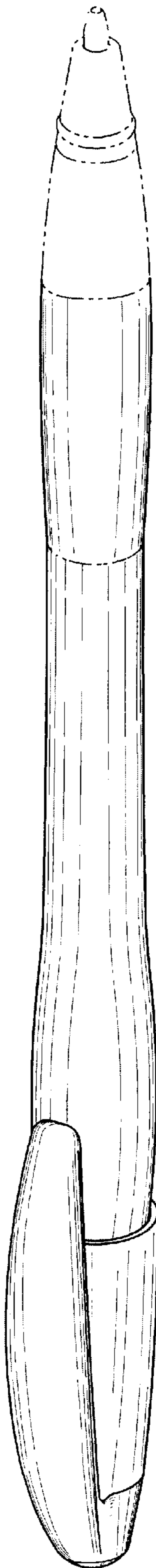

Fig. 7

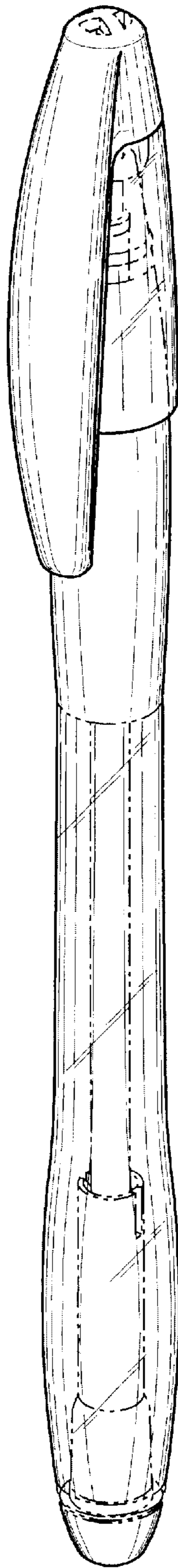

Fig. 8

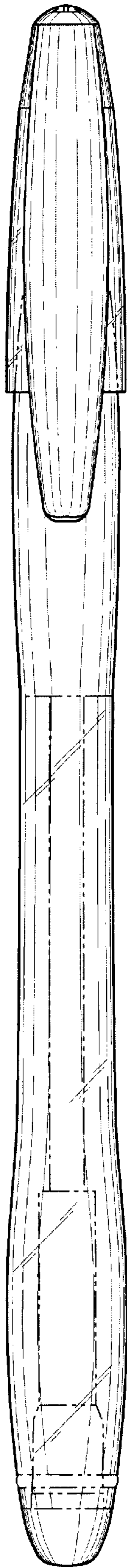

Fig. 9

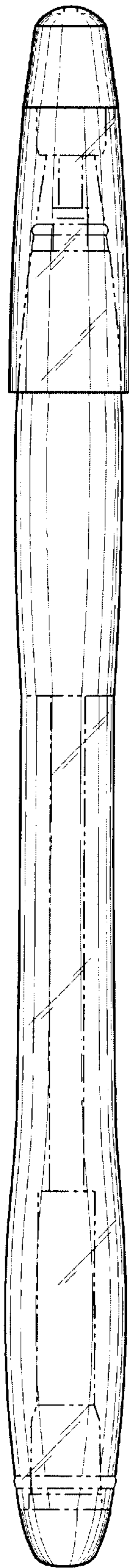

Fig. 10

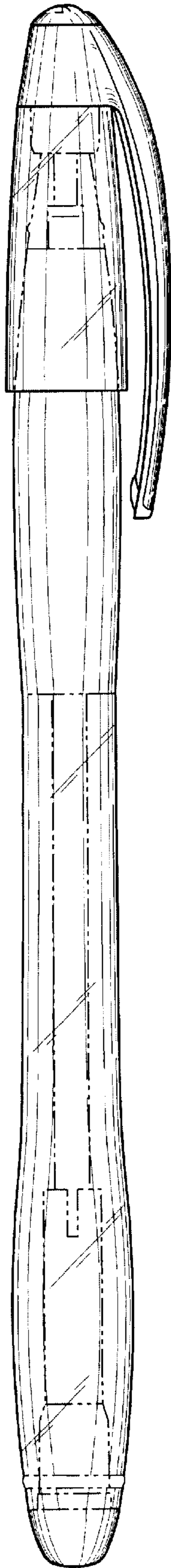

Fig. 11

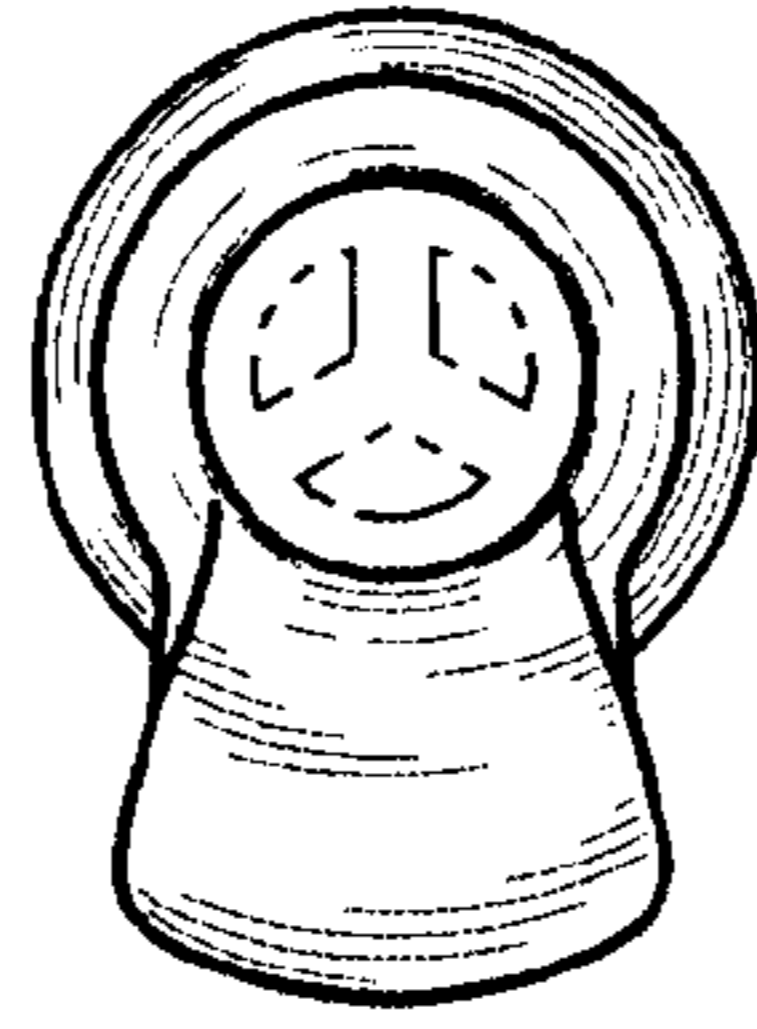

Fig. 12

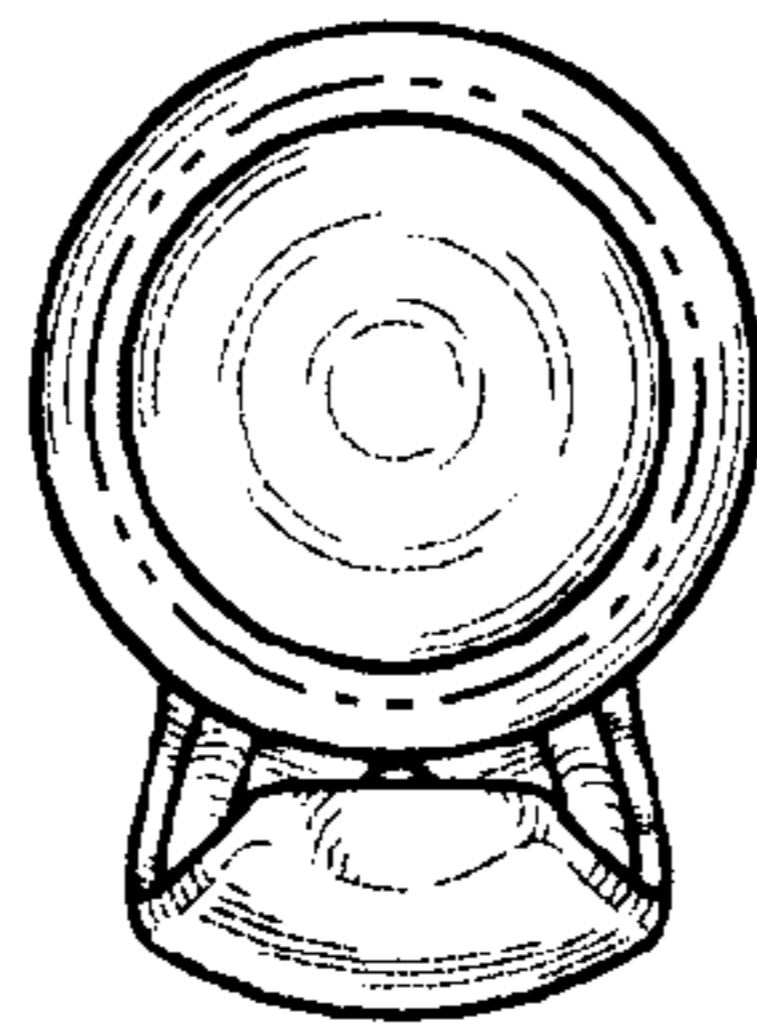

Fig. 13

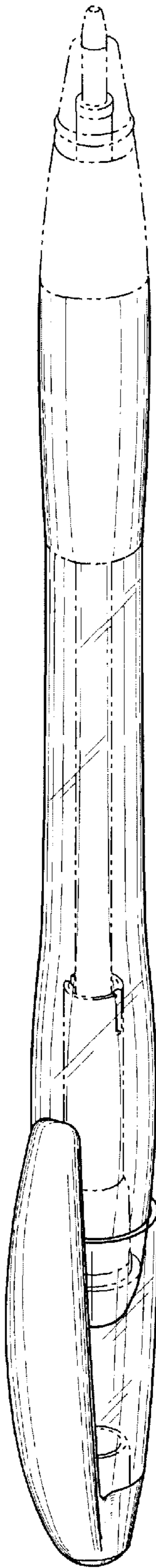

Fig. 14

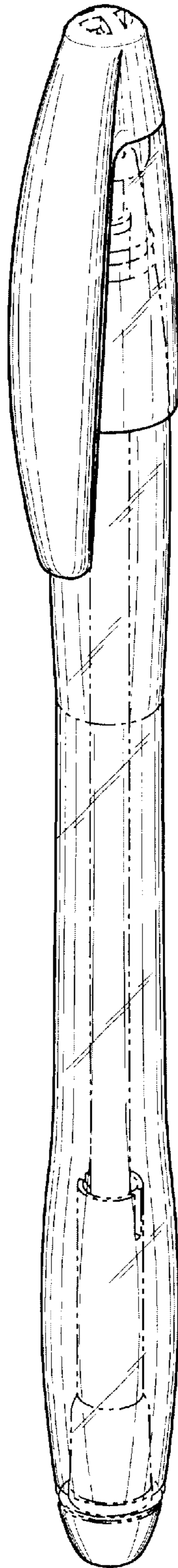

Fig. 15

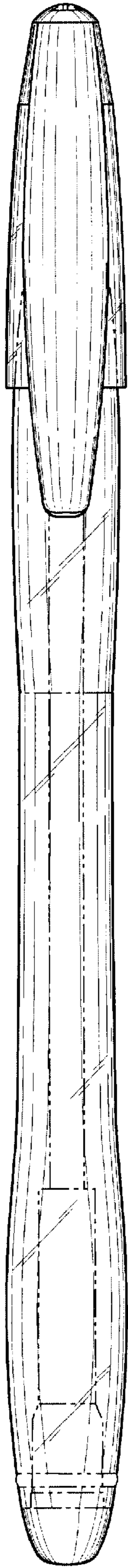

Fig. 16

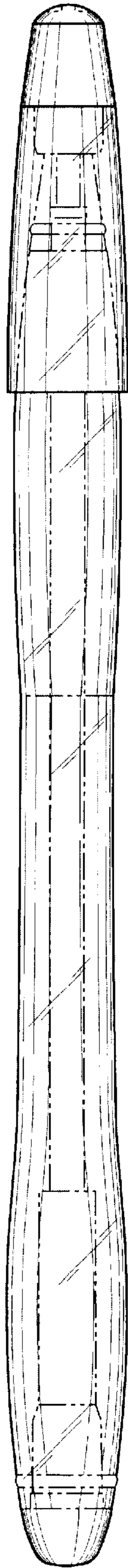

Fig. 17

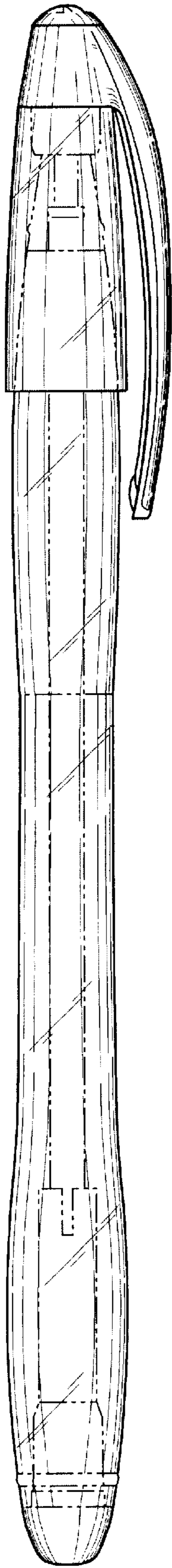

Fig. 18



Fig. 19

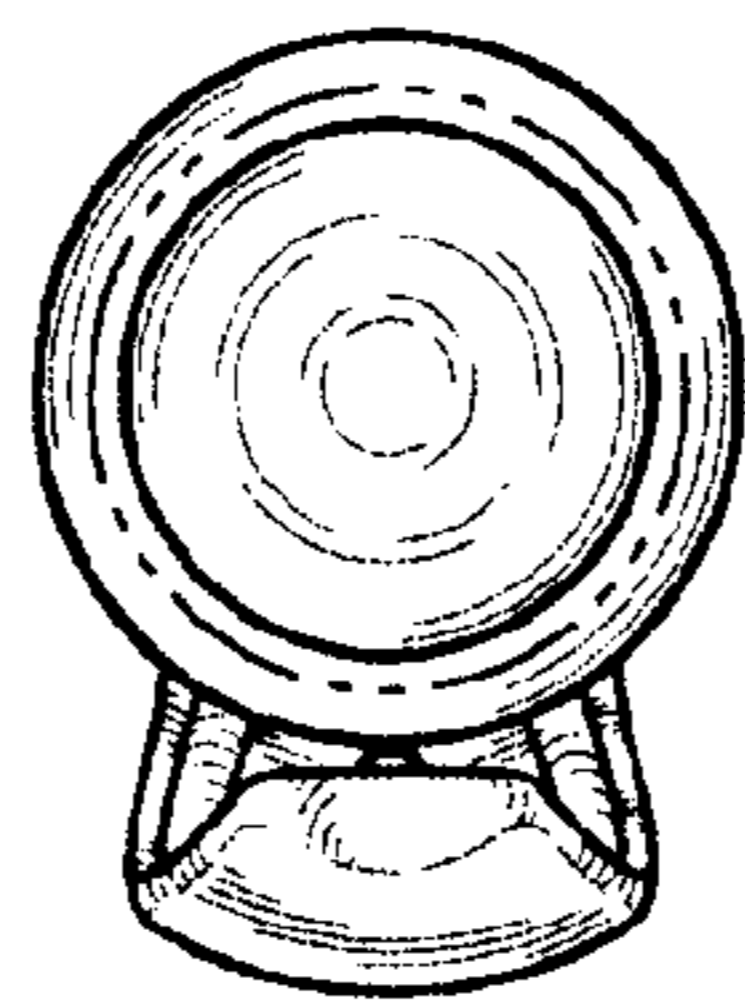

Fig. 20

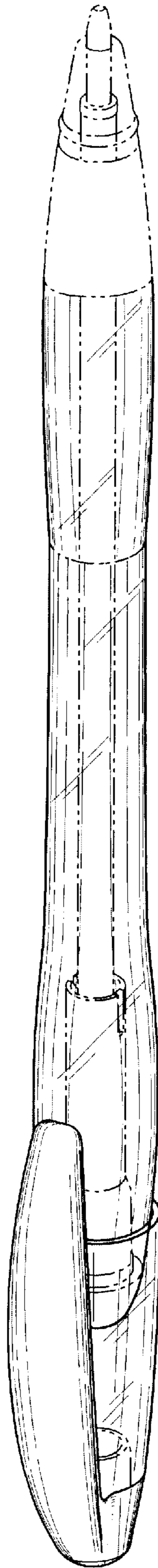

Fig. 21