



US00D489072S

(12) **United States Design Patent**
Nishioka et al.

(10) **Patent No.:** **US D489,072 S**
(45) **Date of Patent:** **** Apr. 27, 2004**

(54) **ILLUMINATING APPARATUS FOR LIQUID CRYSTAL DISPLAY DEVICE**

JP 11-23184 8/1999
JP 11-23185 8/1999
JP 11-23186 8/1999

(75) Inventors: **Akihisa Nishioka**, Iwata-gun (JP);
Satoshi Kawashima, Iwata-gun (JP)

* cited by examiner

(73) Assignee: **Minebea Company Limited**,
Kitasaku-Gun (JP)

Primary Examiner—Freda Nunn

(74) *Attorney, Agent, or Firm*—Oliff & Berridge, PLC

(**) Term: **14 Years**

(57) **CLAIM**

(21) Appl. No.: **29/183,179**

The ornamental design for an illuminating apparatus for liquid crystal display device, as shown and described.

(22) Filed: **Jun. 9, 2003**

DESCRIPTION

Related U.S. Application Data

(62) Division of application No. 29/153,608, filed on Jan. 14, 2002.

The article according to the design is incorporated in a portable telephone, a portable terminal for information device, etc. so as to illuminate a liquid crystal display from the front side.

(30) **Foreign Application Priority Data**

Jul. 18, 2001	(JP)	2001-020999
Jul. 18, 2001	(JP)	2001-021000
Jul. 18, 2001	(JP)	2001-021001
Jul. 18, 2001	(JP)	2001-021002
Jul. 18, 2001	(JP)	2001-021003

Light emitted from the light source, traveling through a light conductive member and a light diffusing plate and introduced into a light conductive plate uniformly illuminates the whole surface of the liquid crystal display thanks to micro-prisms formed on the surface of the light conductive plate. A transparent cover is provided over the exposed surface of the article incorporated in the portable telephone, etc. so as to protect the micro-prisms from dust, dirt, scratches, etc.

(51) **LOC (7) Cl.** **14-02**

(52) **U.S. Cl.** **D14/448; D26/1**

(58) **Field of Search** **D14/371-375, D14/125-129, 140, 448; 345/104, 156, 168, 173, 901-905, 87, 102, 206; 348/180, 184, 325, 739, 790; 349/1, 2, 11, 62, 65, 70, 71, 113; D26/1, 34, 56, 60; 315/169.3**

FIG. 1 is a front view of an illuminating apparatus for liquid crystal display device showing our new design;

FIG. 2 is a top plan view thereof;

FIG. 3 is a bottom view thereof;

FIG. 4 is a left side view thereof;

FIG. 5 is a right side view thereof;

FIG. 6 is a rear thereof;

FIG. 7 is a cross-sectional view taken along the line 7—7 of FIG. 1;

FIG. 8 is a cross-sectional view taken along the line 8—8 of FIG. 1; and,

FIG. 9 is an enlarged view of the portions 9 and 9 of FIG. 7.

(56) **References Cited**

U.S. PATENT DOCUMENTS

5,280,372 A	*	1/1994	Horiuchi	349/65
6,175,353 B1	*	1/2001	Hoeksma	345/102

FOREIGN PATENT DOCUMENTS

JP	10-36177	12/1998
JP	10-36178	12/1998
JP	10-37597	12/1998
JP	10-37598	12/1998

A light source (i.e., light emitting diode) for illumination is disposed inside a housing frame which is shown at the lower side of FIG. 1.

Two flexible printed circuit boards extending downwardly in FIG. 1 are connected to a power source.

1 Claim, 6 Drawing Sheets

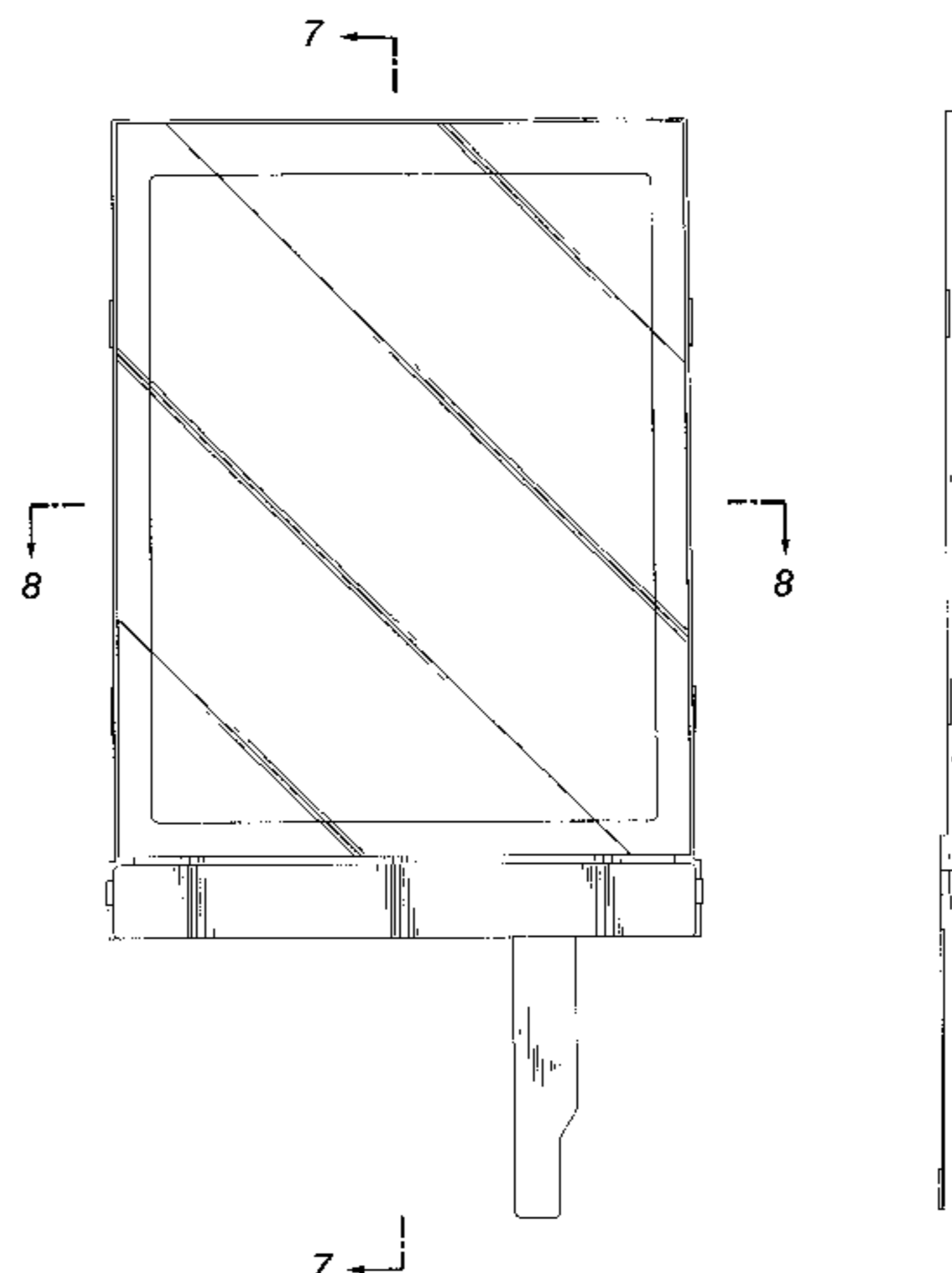

FIG. 1

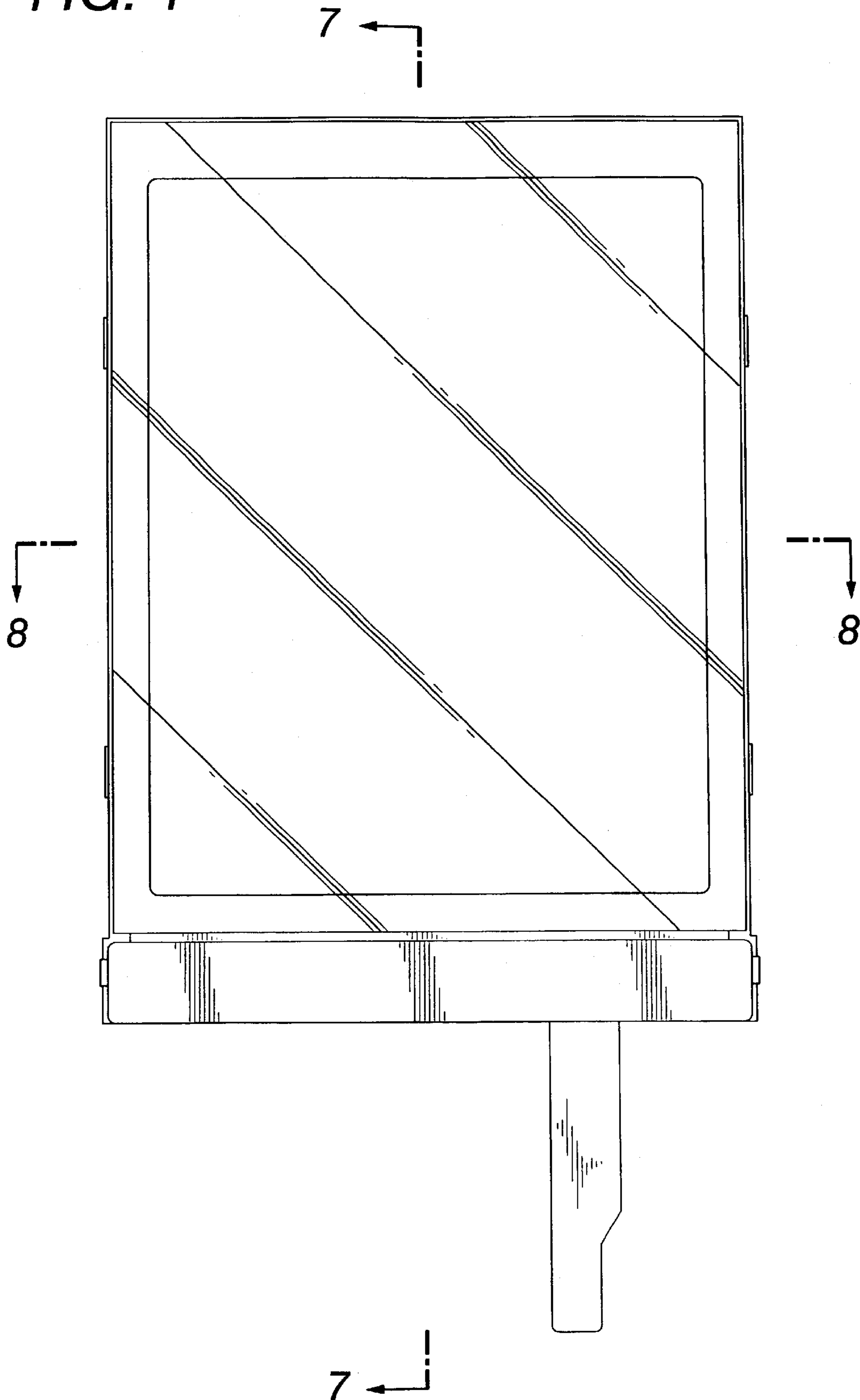

FIG. 2

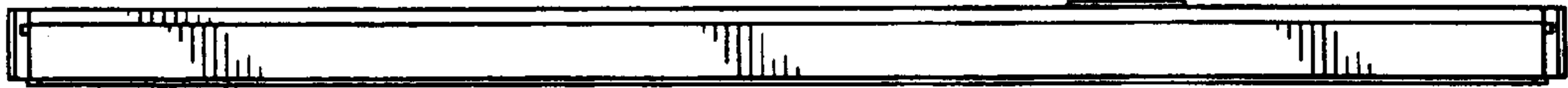

FIG. 3



FIG. 4



FIG. 5

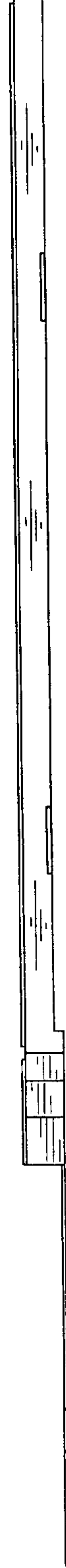

FIG. 6

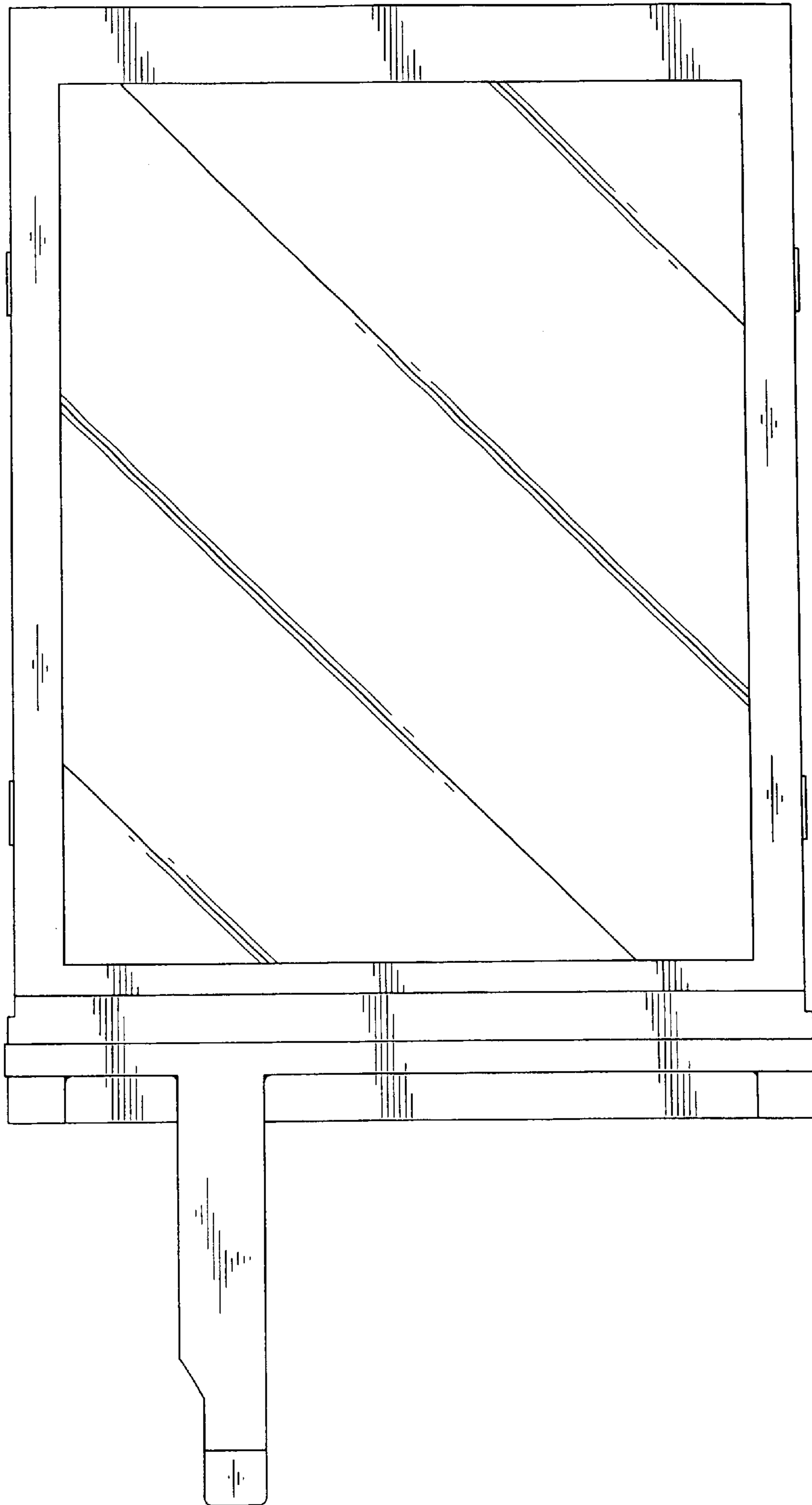

FIG. 7

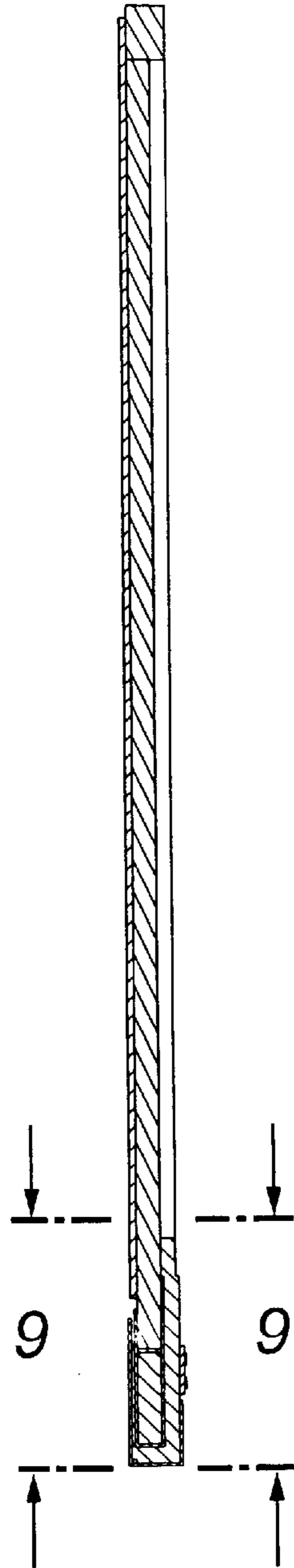

FIG. 8

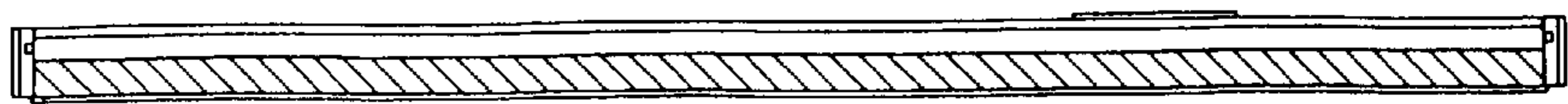

FIG. 9

