



US00D489050S

(12) **United States Design Patent**
Kanoh et al.

(10) **Patent No.: US D489,050 S**

(45) **Date of Patent: ** Apr. 27, 2004**

(54) **DIGITAL DISK PLAYER**

(75) Inventors: **Kenichi Kanoh**, Kanagawa-ken (JP);
Katsuyuki Kaneko, Tokyo (JP)

(73) Assignee: **Victor Company of Japan, Limited**
(JP)

(**) Term: **14 Years**

(21) Appl. No.: **29/162,626**

(22) Filed: **Jun. 19, 2002**

(30) **Foreign Application Priority Data**

Jan. 31, 2002 (JP) 2002-002154
Jan. 31, 2002 (JP) 2002-002155

(51) **LOC (7) Cl. 14-01**

(52) **U.S. Cl. D14/156**

(58) **Field of Search** D14/135-136,
D14/156-157, 160-164, 167-168, 188,
193-198; 369/6-7, 75.1, 75.2, 77.1, 77.2;
455/344, 347, 350-351

(56) **References Cited**

U.S. PATENT DOCUMENTS

D404,033 S * 1/1999 Fong D14/171
D411,198 S * 6/1999 Kawase D14/168
D430,550 S * 9/2000 Nakajima et al. D14/156
D431,548 S * 10/2000 Rashid et al. D14/168
D435,534 S * 12/2000 Horikoshi D14/168

* cited by examiner

Primary Examiner—Nanda Bondade

(74) *Attorney, Agent, or Firm*—Saidman DesignLaw Group

(57) **CLAIM**

The ornamental design for a digital disk player, as shown and described.

DESCRIPTION

FIG. 1 is a front view of a digital disk player showing our new design;

FIG. 2 is a rear view thereof;

FIG. 3 is a top plan view thereof;

FIG. 4 is a bottom view thereof;

FIG. 5 is a left side view thereof, the right side view being a mirror image;

FIG. 6 is a left side view thereof with the top cover shown in its open position, the right side view being a mirror image;

FIG. 7 is a top plan view thereof;

FIG. 8 is a front view of a second embodiment of a digital disk player showing our new design;

FIG. 9 is a rear view thereof;

FIG. 10 is a top plan view thereof;

FIG. 11 is a bottom plan view thereof;

FIG. 12 is a left side view thereof, the right side view being a mirror image;

FIG. 13 is a left side view thereof with the top cover shown in its open position, the right side view being a mirror image;

and,

FIG. 14 is a top plan view thereof.

The thin diagonal lines in the drawings indicate translucent portions.

1 Claim, 8 Drawing Sheets

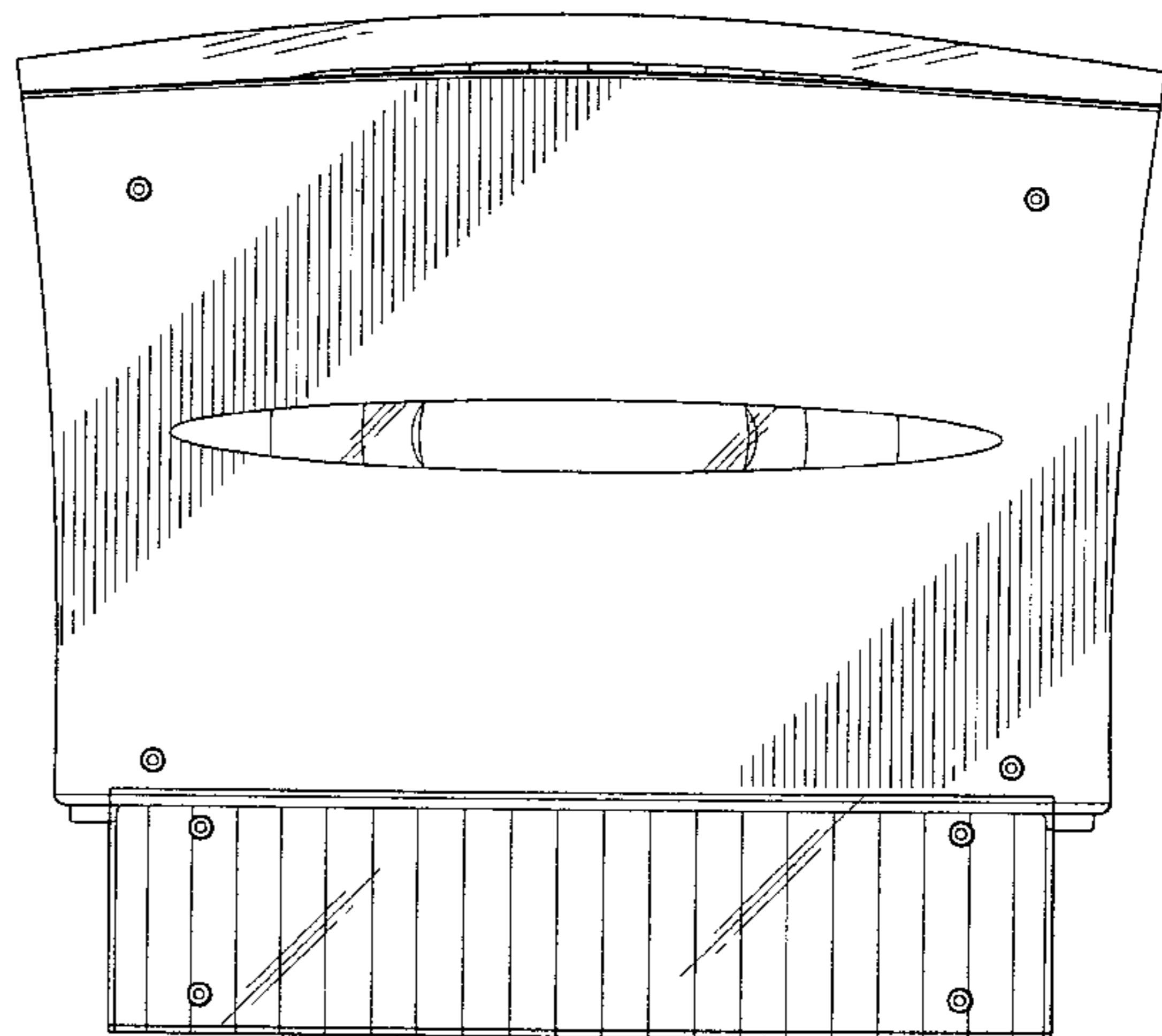
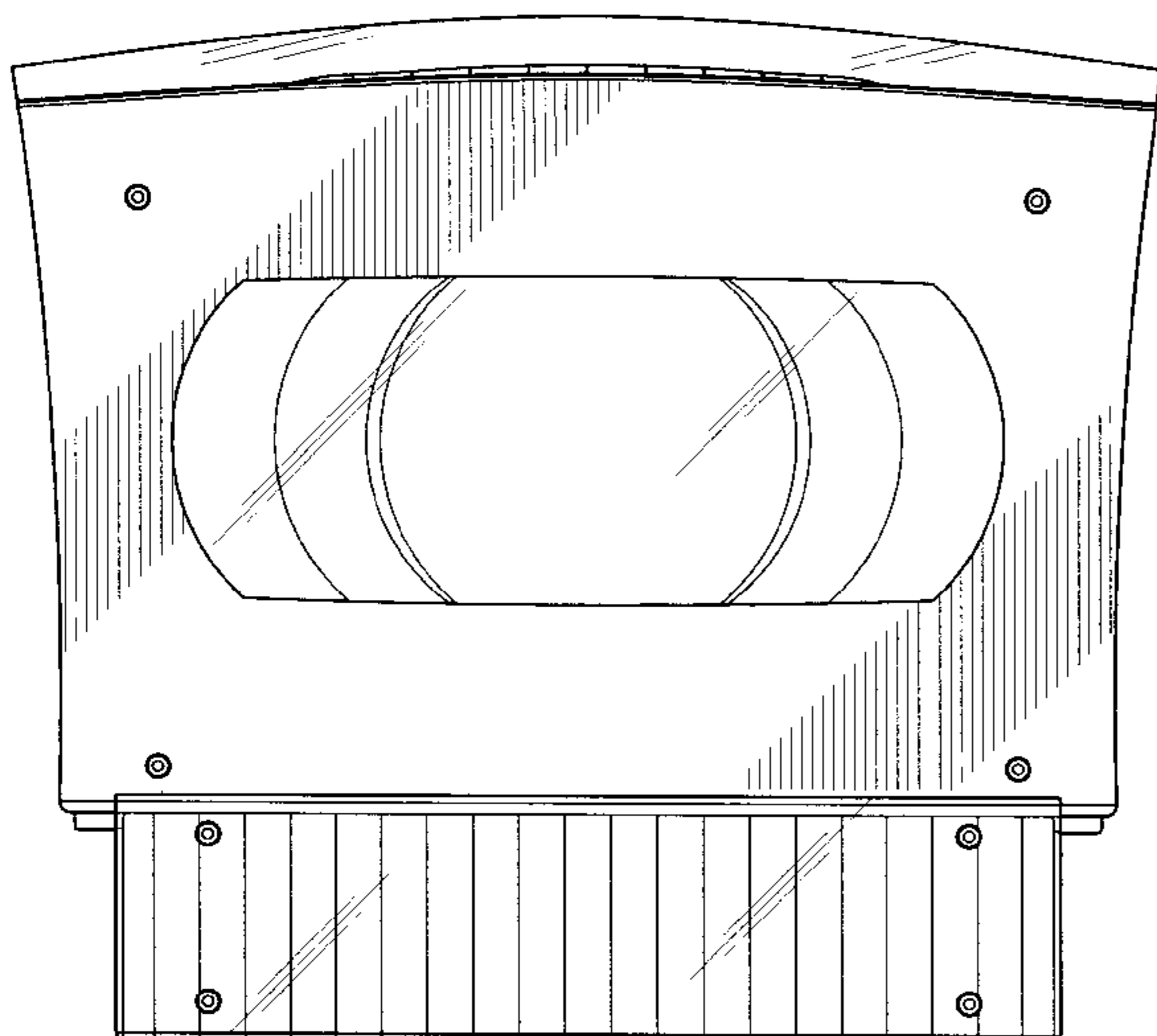

FIG.1

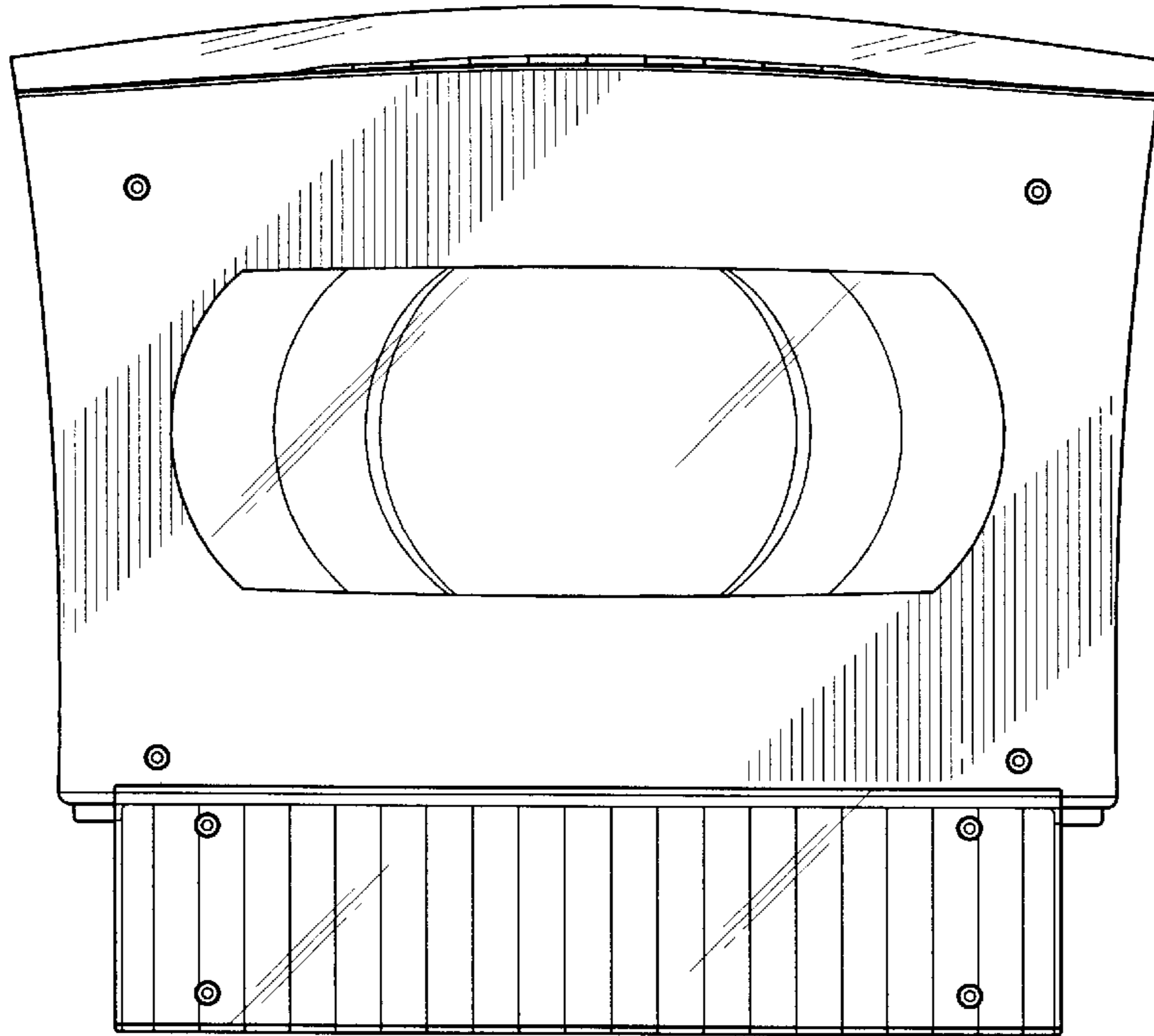

FIG.2

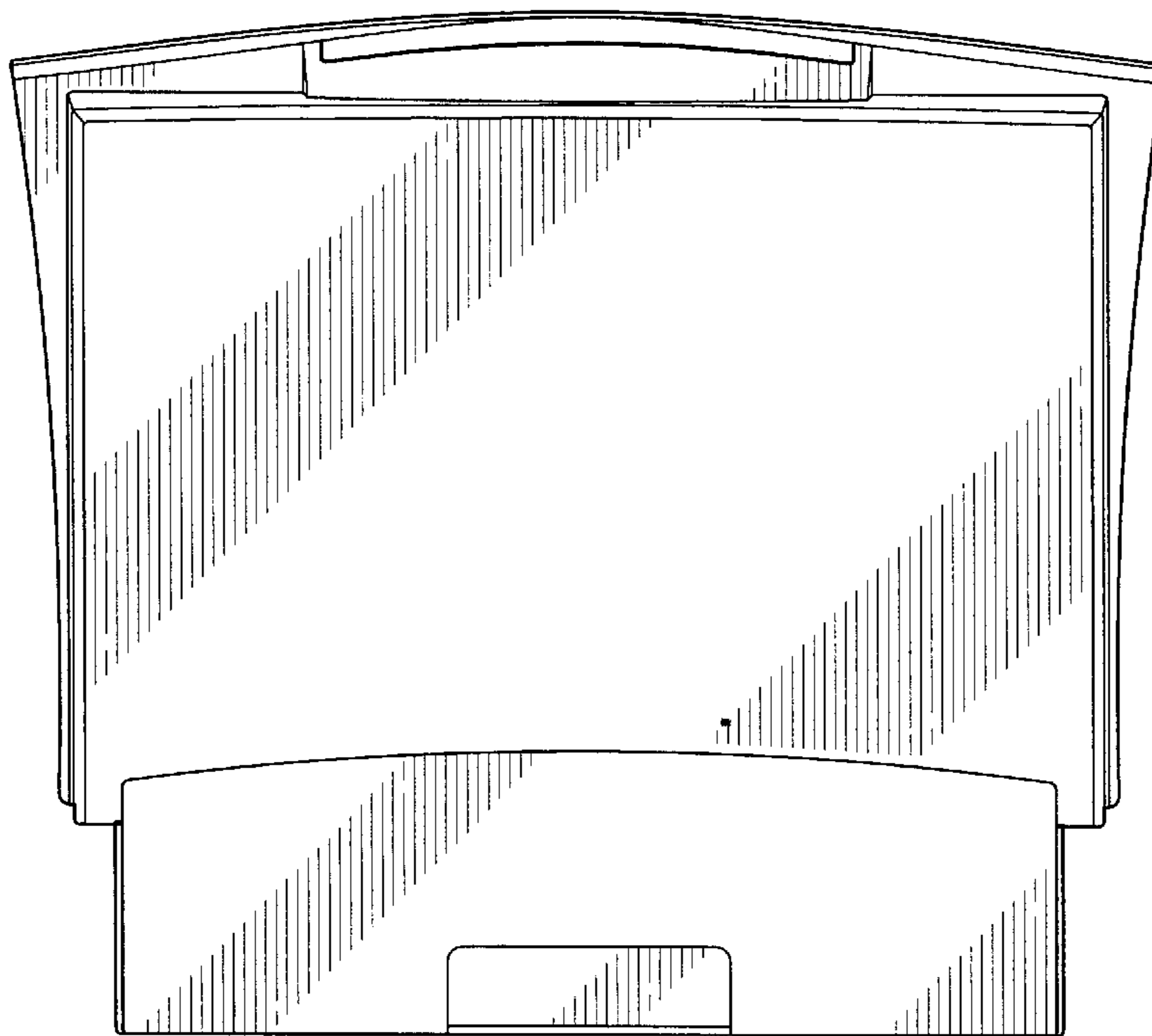

FIG. 3

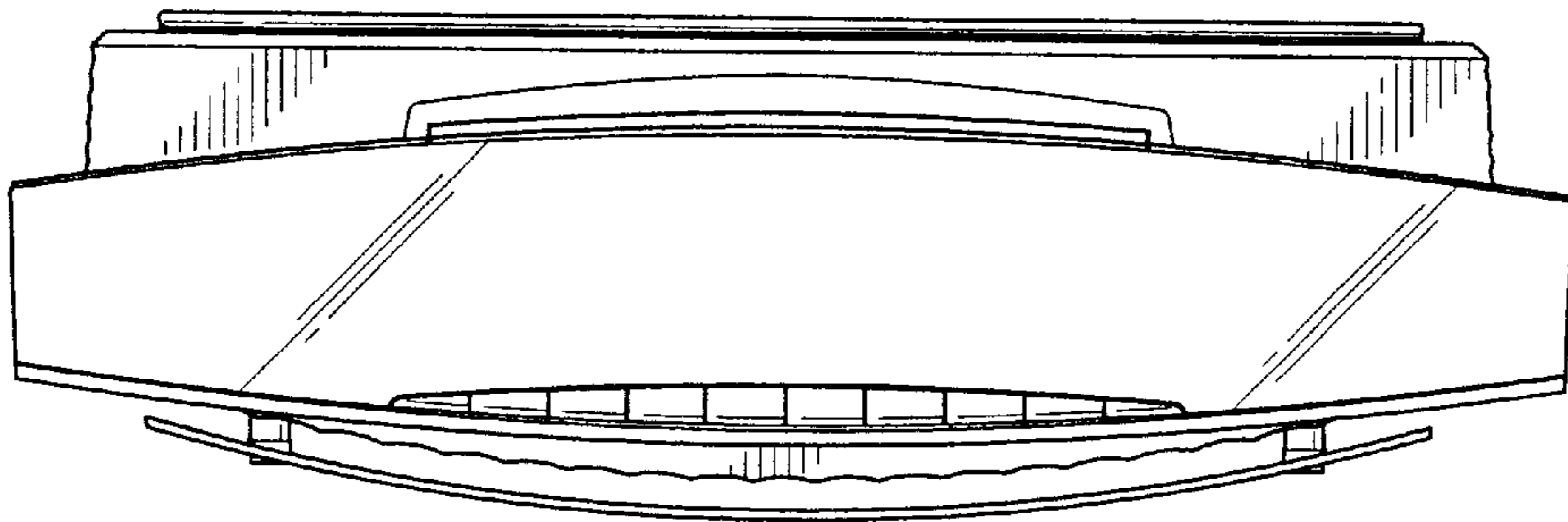

FIG. 4

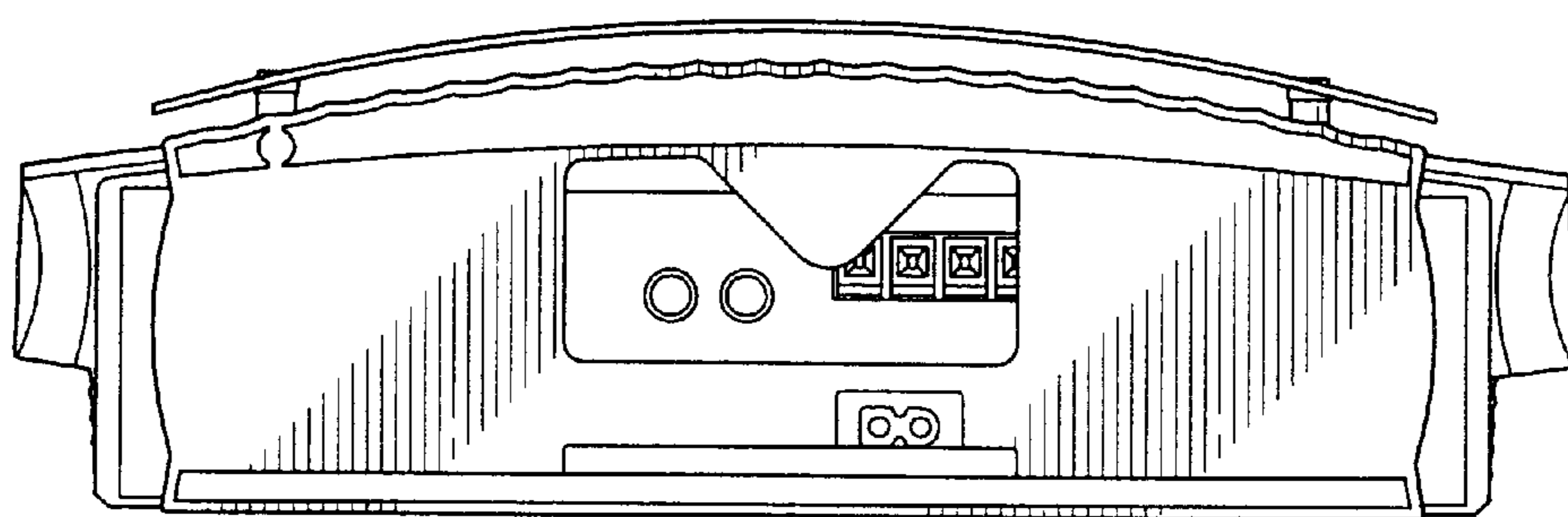

FIG.5

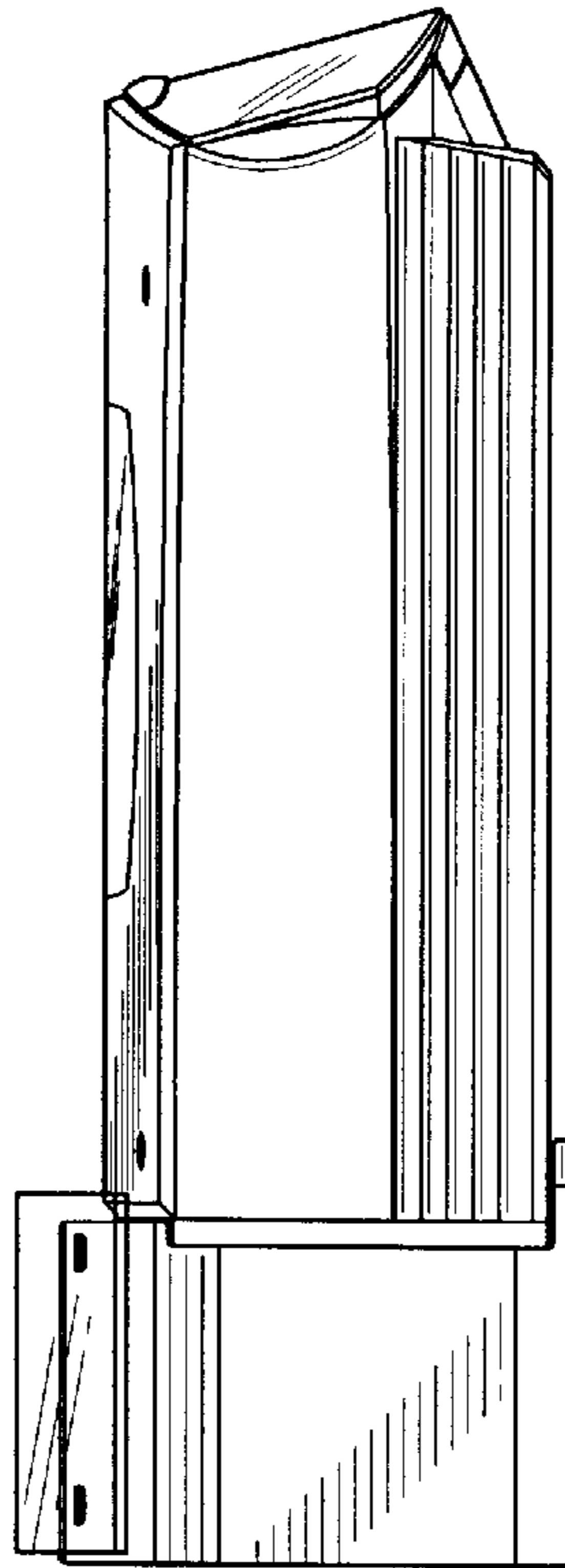

FIG.6

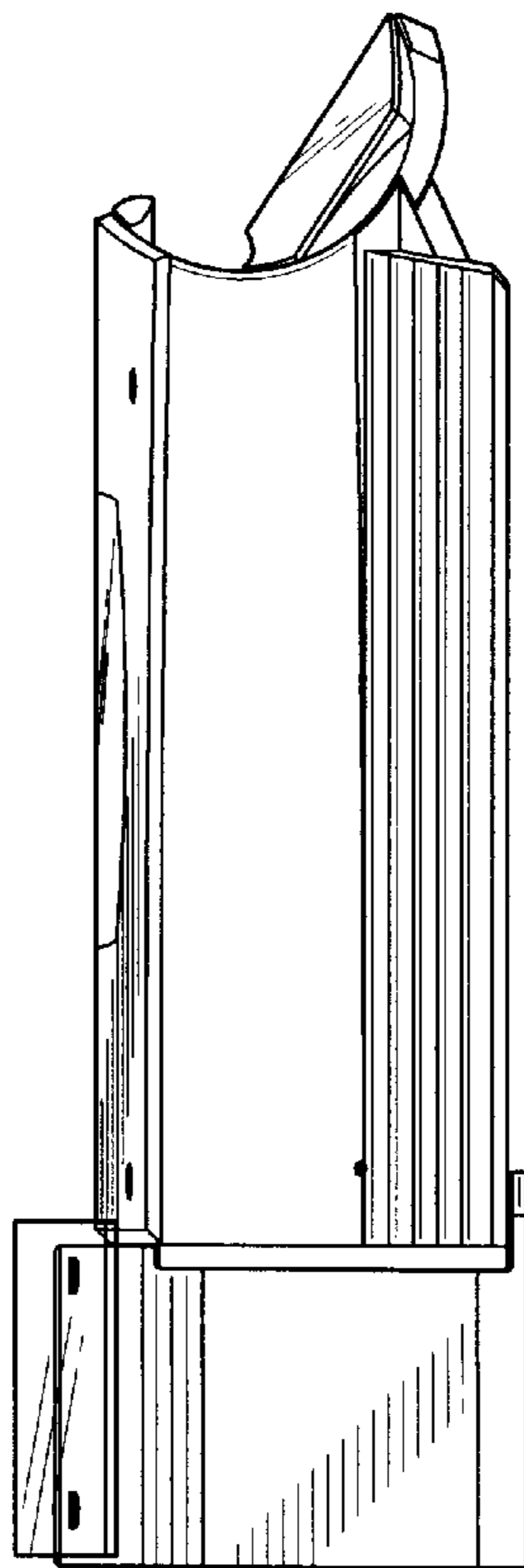

FIG. 7

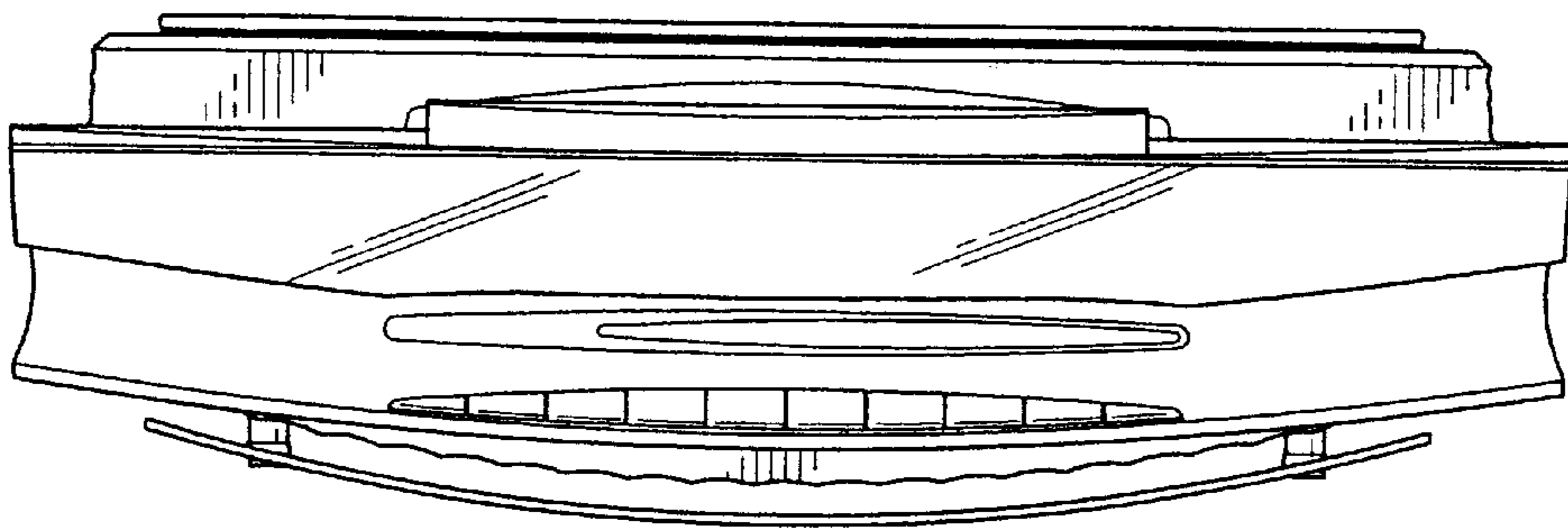

FIG. 8

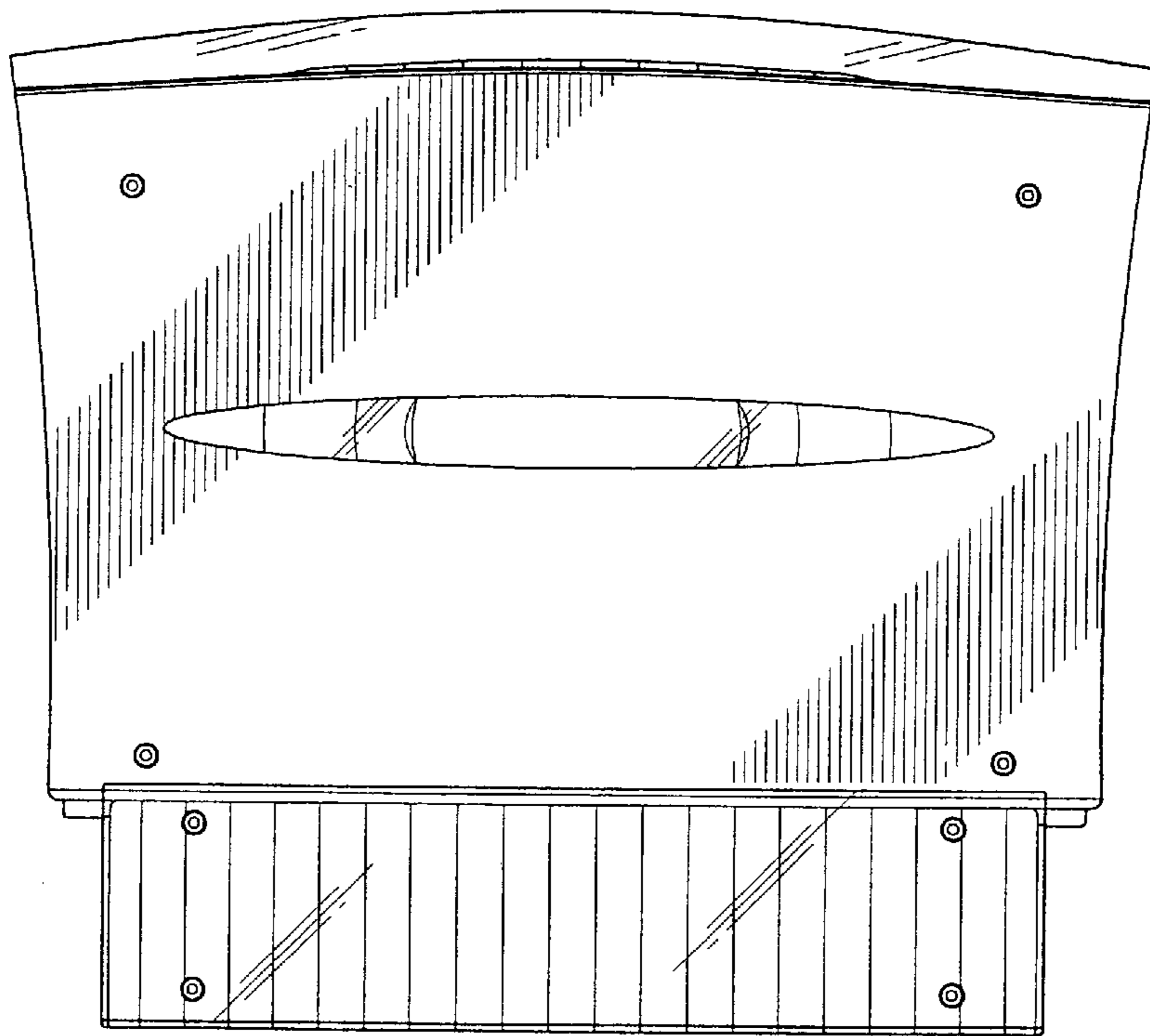

FIG. 9

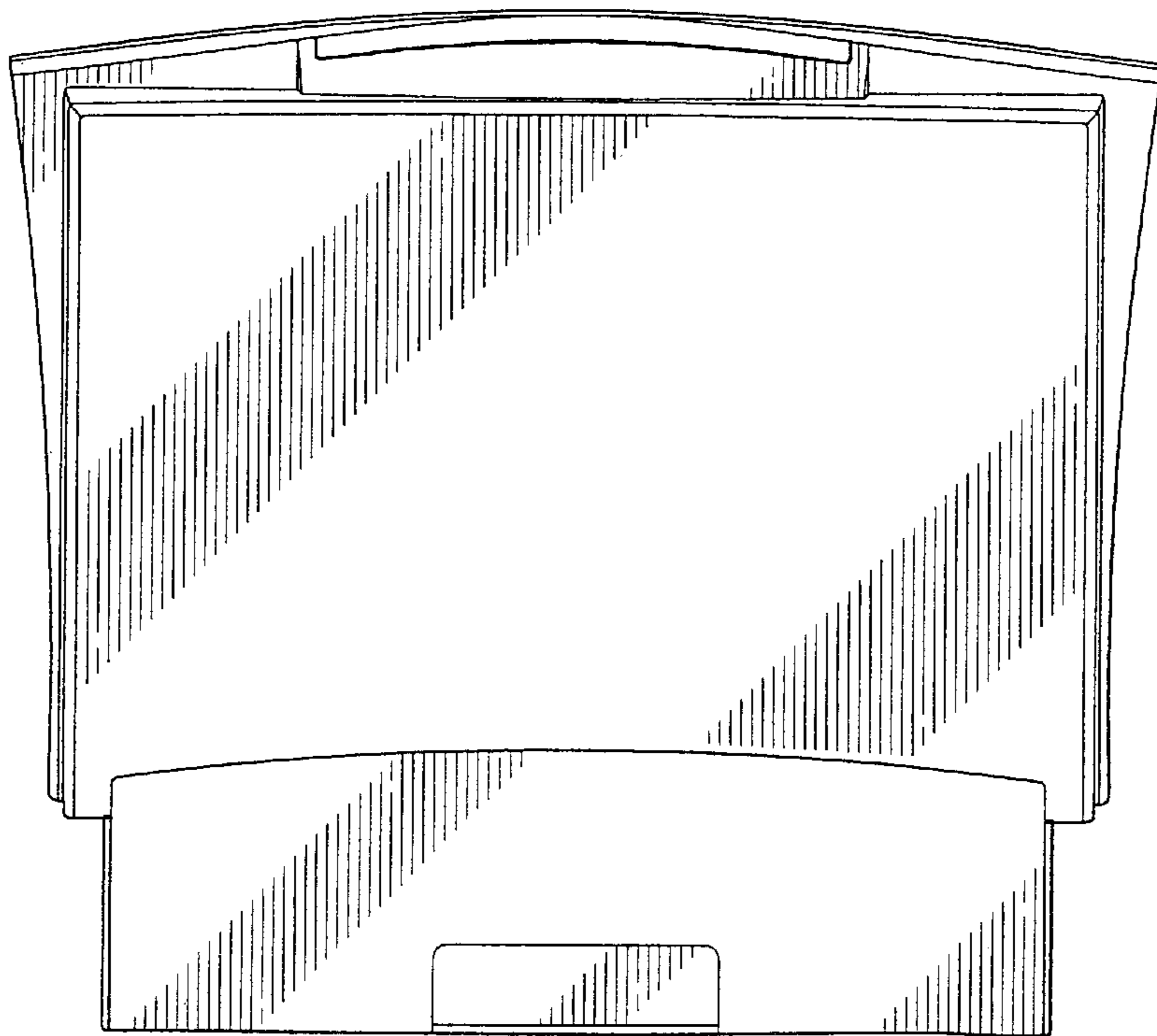

FIG. 10

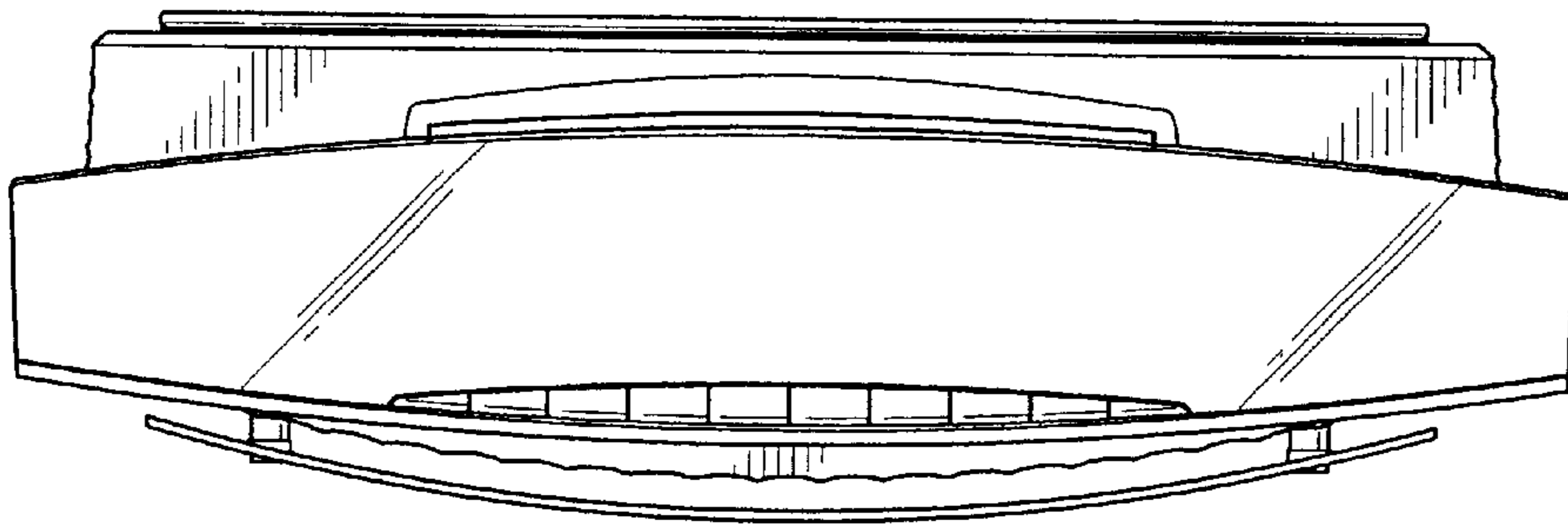

FIG. 11

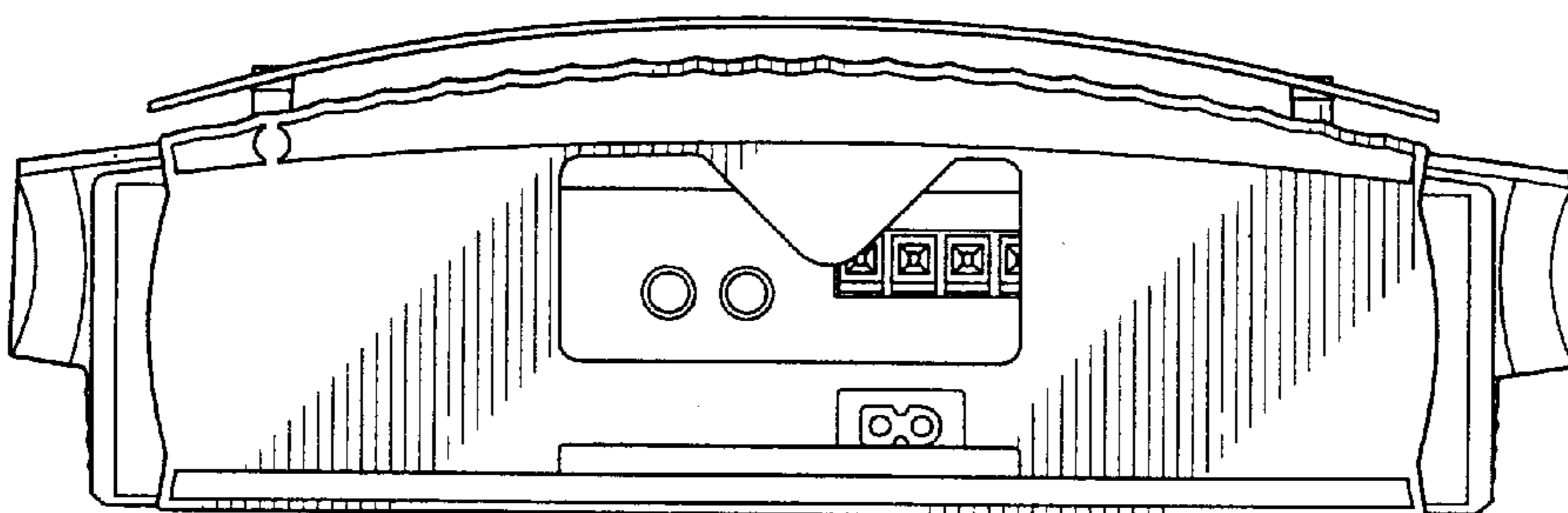

FIG.12

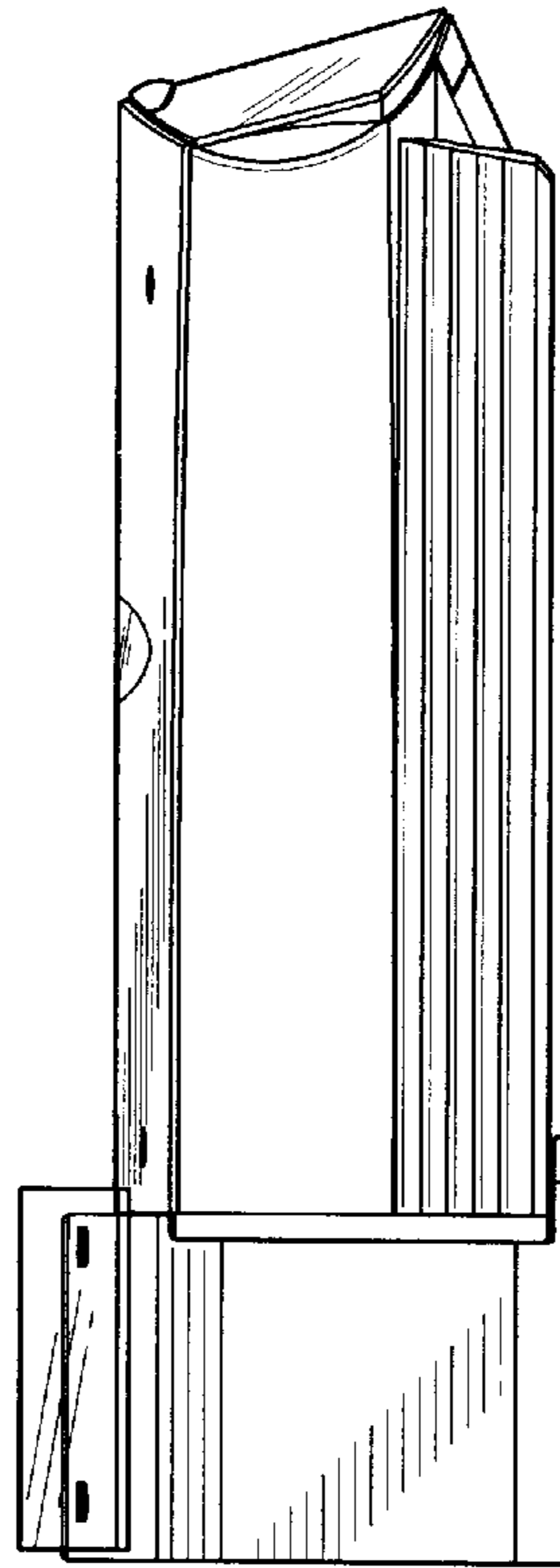

FIG.13

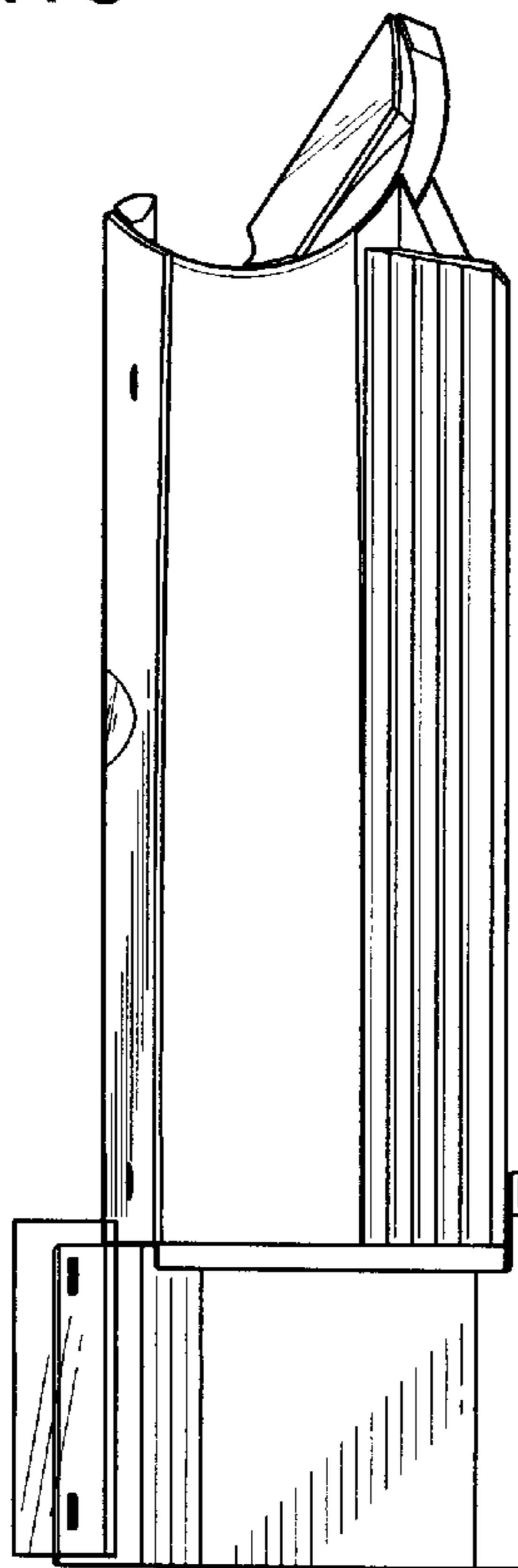

FIG. 14

