



US00D488984S

(12) **United States Design Patent**
Chun-Lee

(10) **Patent No.:** **US D488,984 S**

(45) **Date of Patent:** **** Apr. 27, 2004**

(54) **HAND GRIP**

D429,990 S * 8/2000 Kunkler D8/303
D469,330 S * 1/2003 Novoa D8/303

(75) Inventor: **Pong Chun-Lee**, Chang Hua (TW)

* cited by examiner

(73) Assignee: **Success & Tech. Industrial Co., Ltd.**,
Taichung (TW)

Primary Examiner—Melody N. Brown
(74) *Attorney, Agent, or Firm*—Dennison, Schultz,
Dougherty & MacDonald

(**) Term: **14 Years**

(57) **CLAIM**

(21) Appl. No.: **29/177,402**

The ornamental design for a hand grip, as shown and described.

(22) Filed: **Mar. 11, 2003**

(51) **LOC (7) Cl.** **08-06**

(52) **U.S. Cl.** **D8/303**

(58) **Field of Search** D8/300, 303; D12/179,
D12/114; 74/551.8, 551.9, 523; 16/110.1,
421, 430

DESCRIPTION

(56) **References Cited**

U.S. PATENT DOCUMENTS

D269,408 S * 6/1983 Merritt D8/303
D340,636 S * 10/1993 Ming-Chang D8/303

FIG. 1 is a perspective view of a hand grip of the present design.

FIG. 2 is a front elevational view of the present design.

FIG. 3 is a rear elevational view of the present design.

FIG. 4 is a left elevational view of the present design.

FIG. 5 is a right elevational view of the present design.

FIG. 6 is a top plan view of the present design; and,

FIG. 7 is a bottom plan view of the present design.

1 Claim, 7 Drawing Sheets

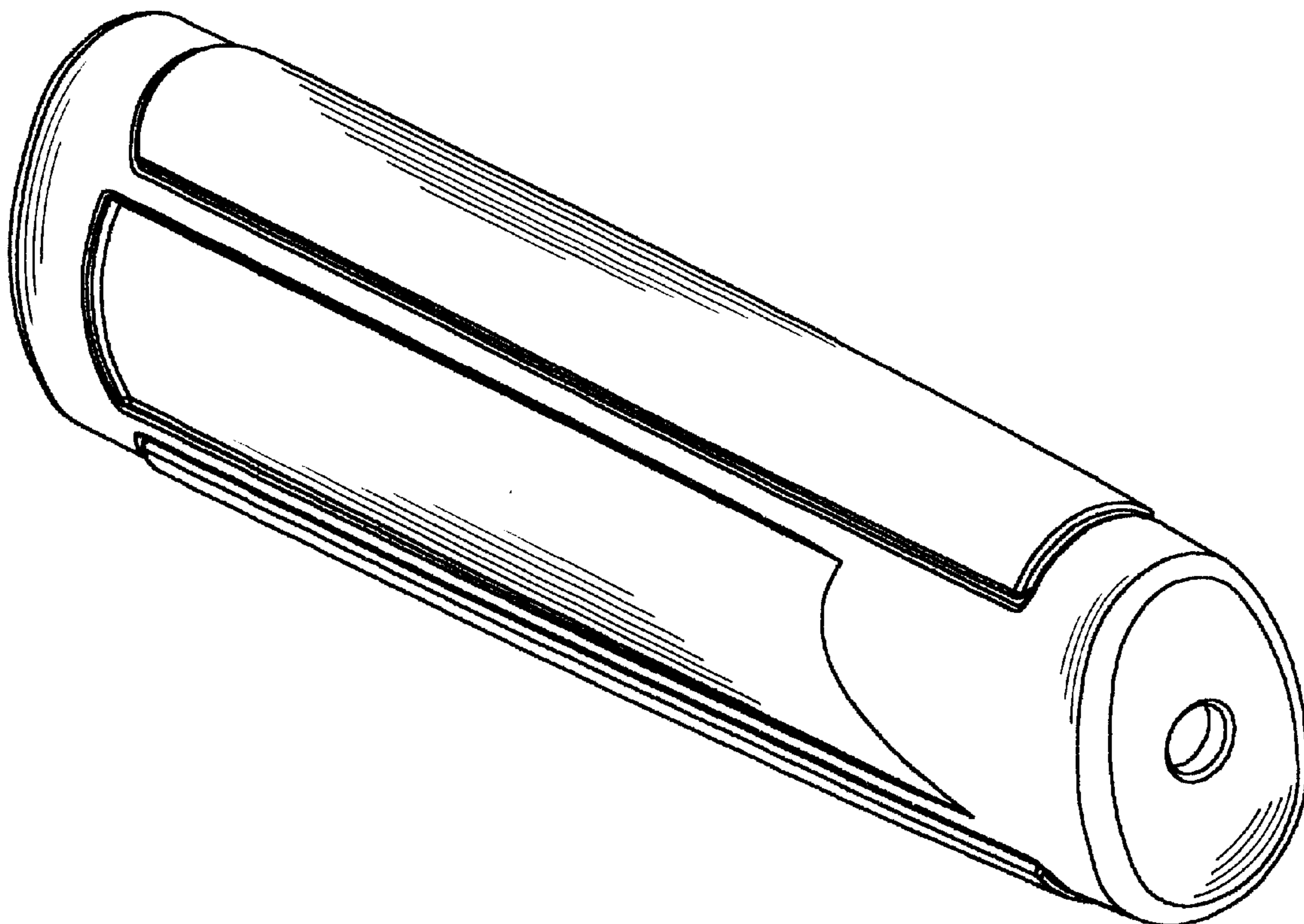

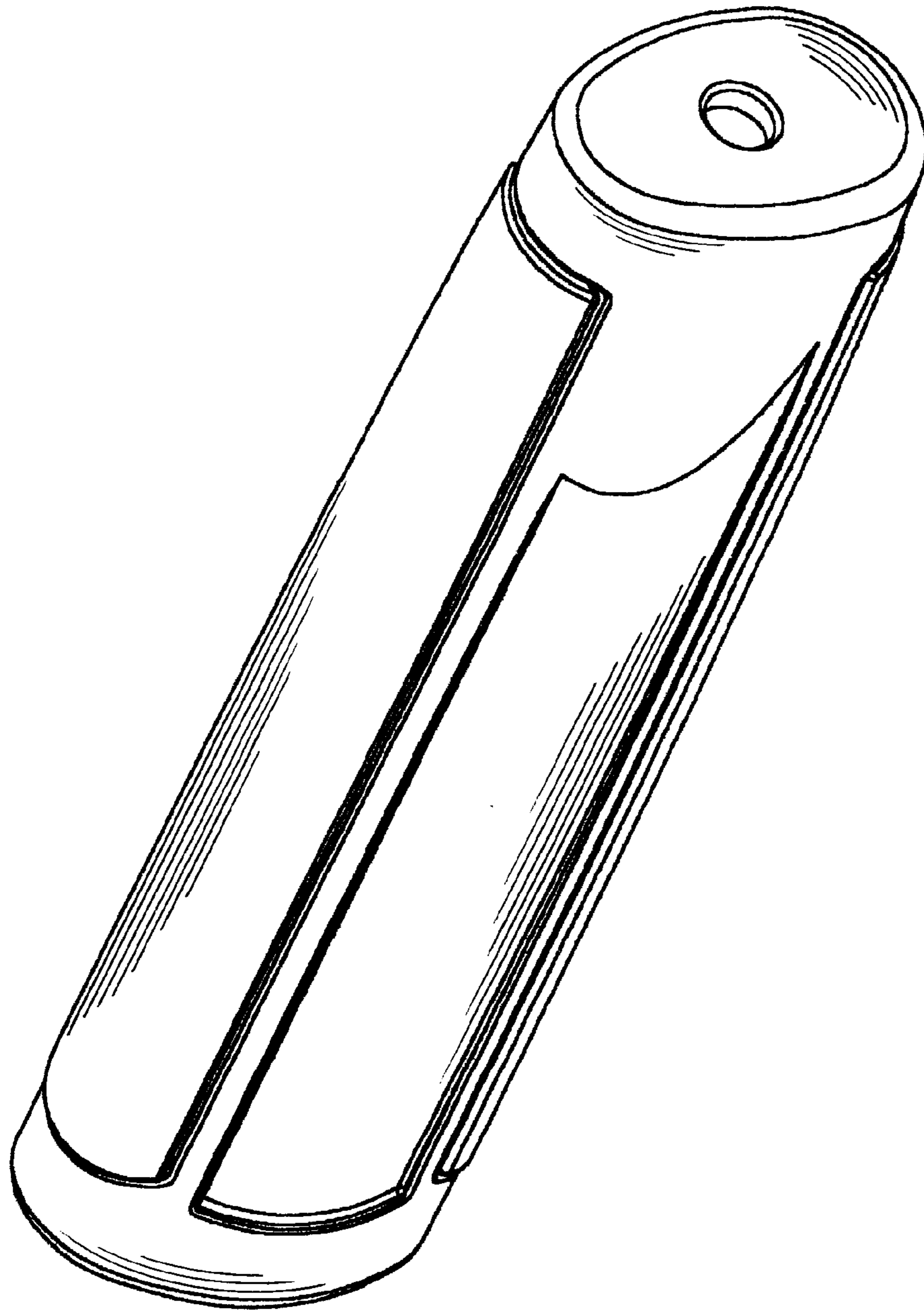

Fig. 1

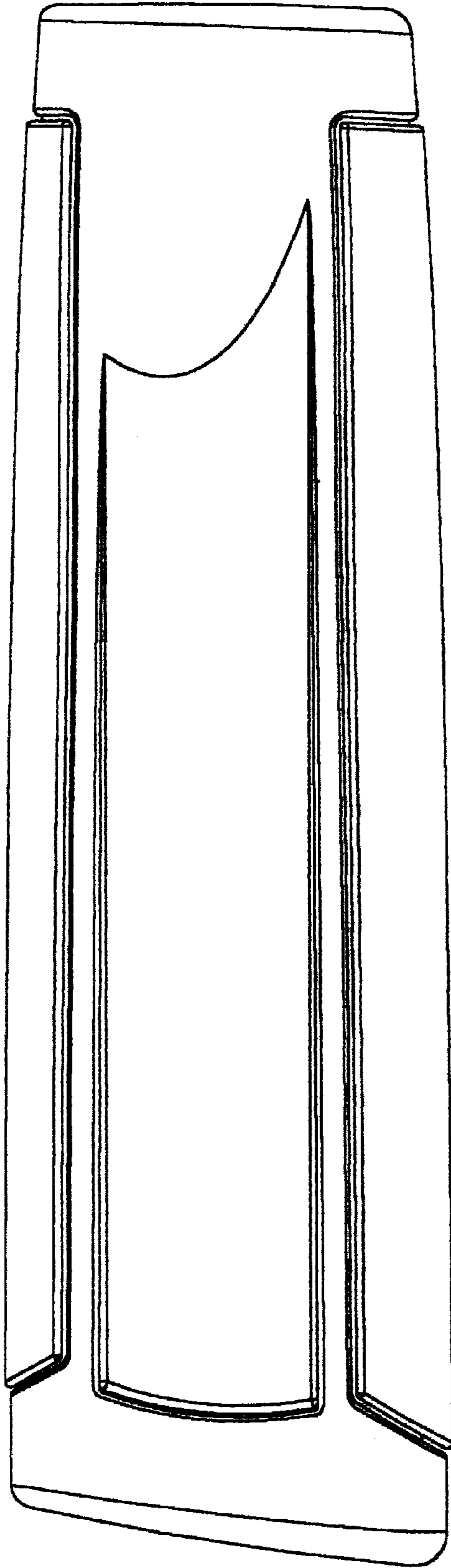

Fig. 2

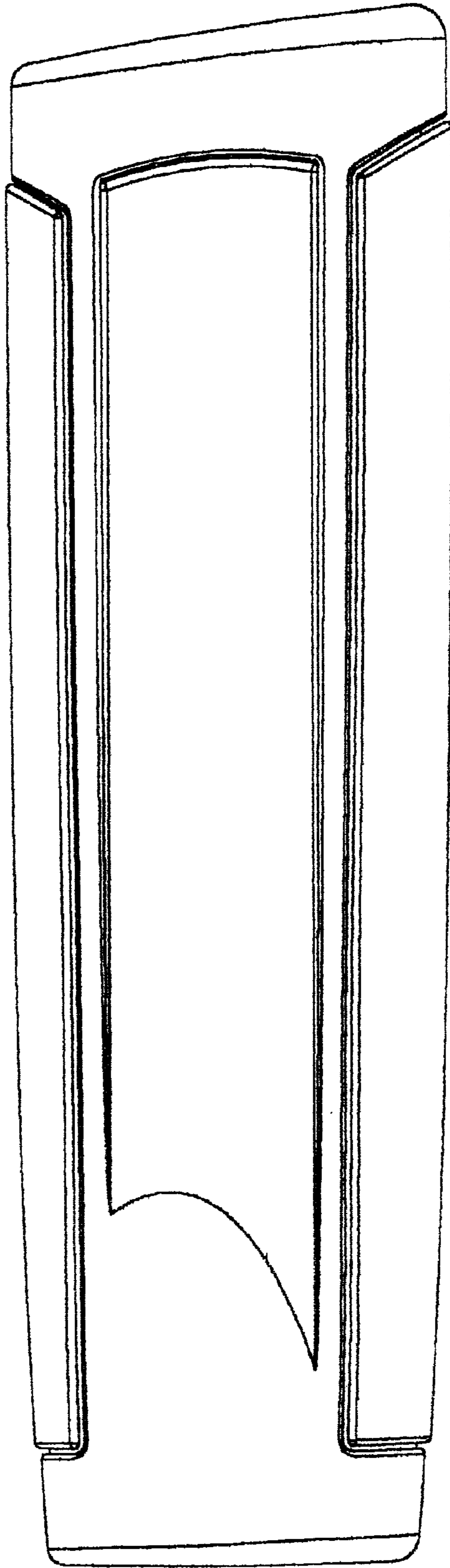

Fig. 3

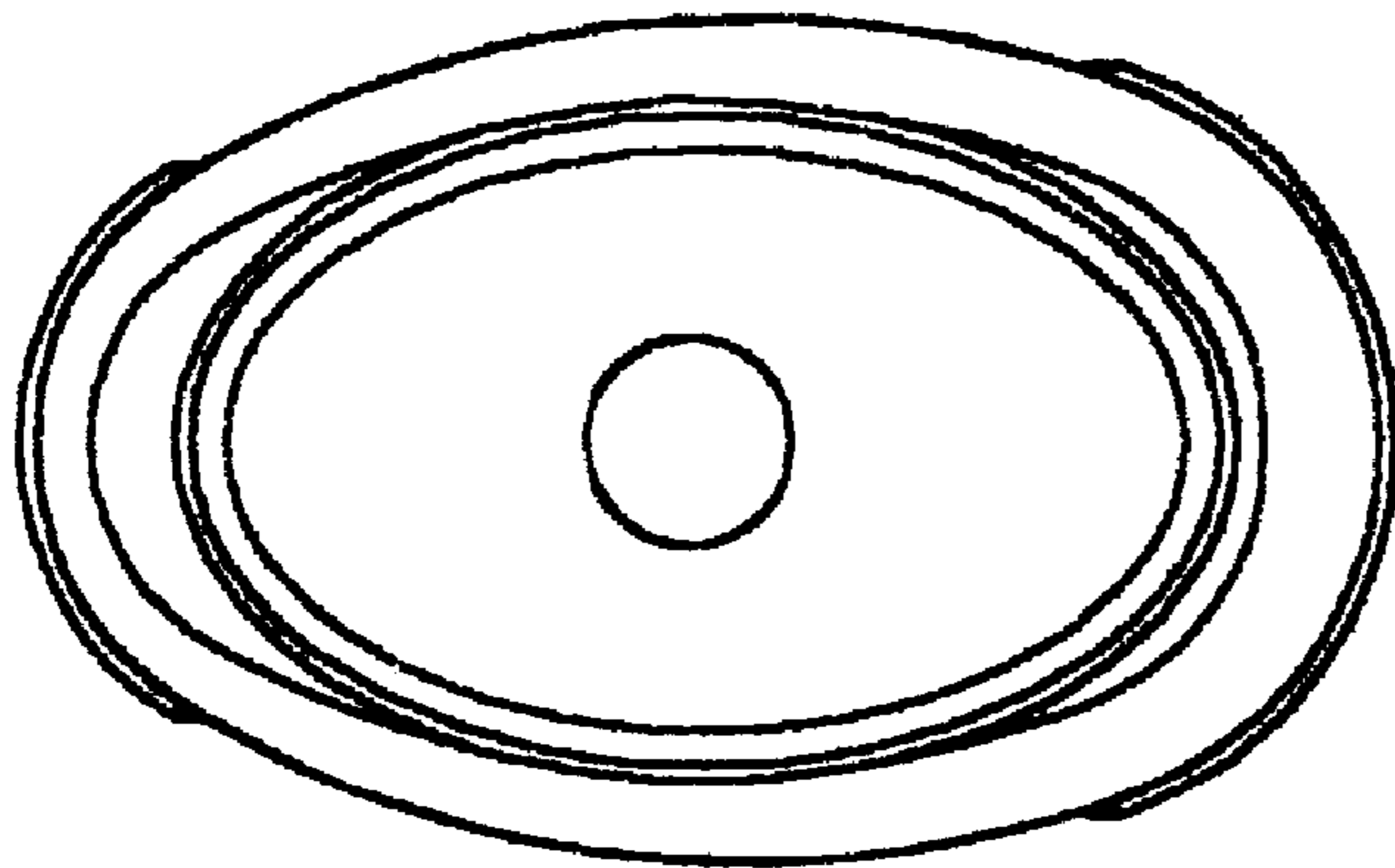

Fig. 4

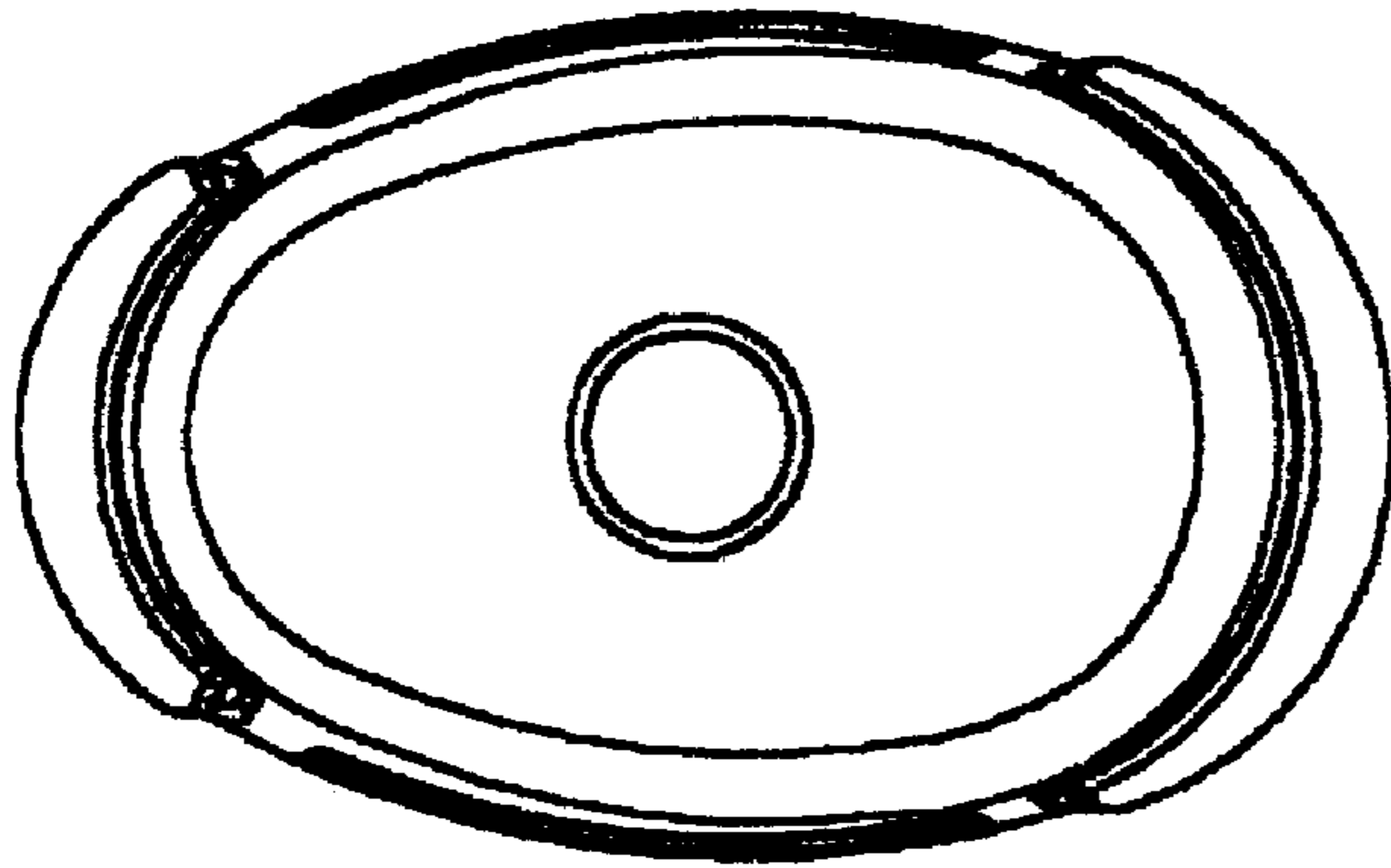

Fig. 5

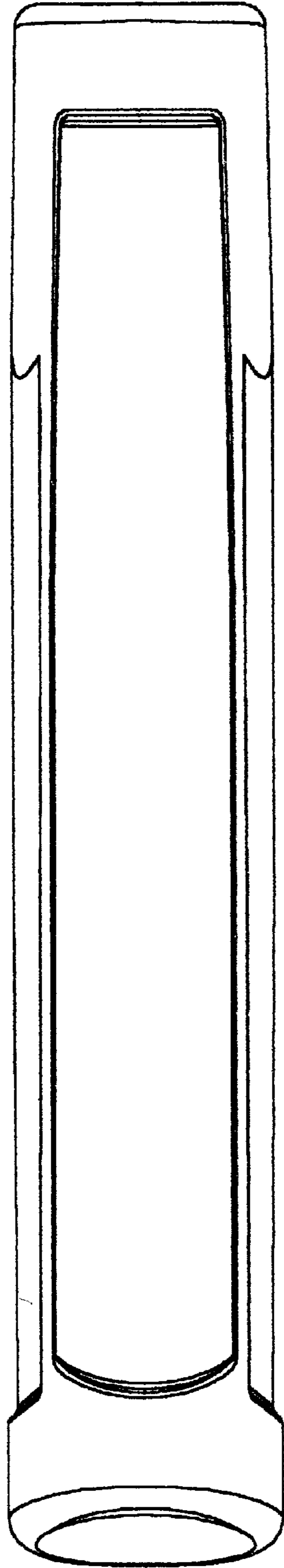

Fig. 6

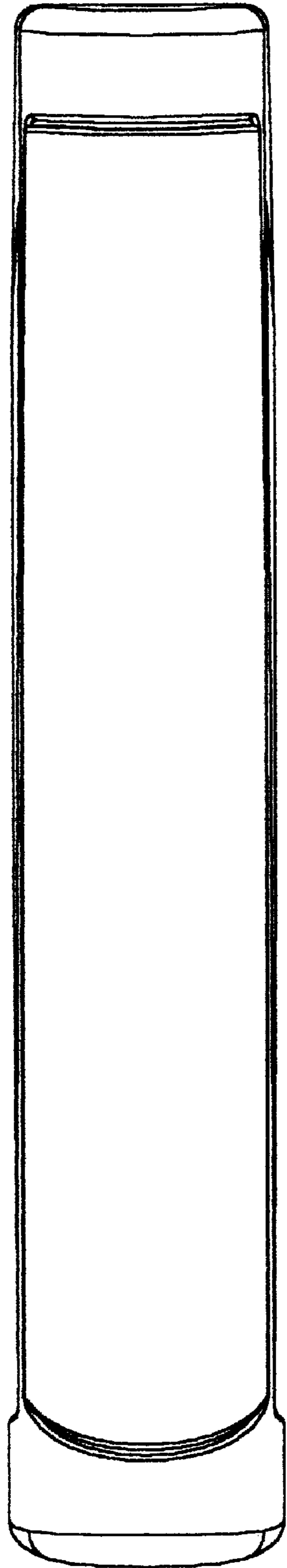

Fig. 7