



US00D488979S

(12) **United States Design Patent**
Liao

(10) **Patent No.:** **US D488,979 S**

(45) **Date of Patent:** **** Apr. 27, 2004**

(54) **STANDING DEVICE FOR A SPRAY GUN**

(76) **Inventor:** **Hsing-Mei Liao**, No. 8, Lane 21, Jung Hua Rd., Wu Jih Hsiang, Taichung Hsien (TW)

(**) **Term:** **14 Years**

(21) **Appl. No.:** **29/178,190**

(22) **Filed:** **Mar. 24, 2003**

(51) **LOC (7) Cl.** **08-05**

(52) **U.S. Cl.** **D8/71**

(58) **Field of Search** D8/71, 14.1, 64, D8/66, 70, 72, 73, 74, 349, 354, 373; D15/130, 132, 138, 139, 140, 141; 33/474, 533, 613; 81/177.1, 177.4, 437, 438, 439, 490; 82/161; 83/581, 760, 762, 763, 764, 766; 142/48, 49, 55; 211/60.1, 70.6; 248/80, 153, 175, 176.1, 201, 304, 309.1, 312, 312.1, 315, 316.7, 316.8; 269/41, 42, 283

(56) **References Cited**

U.S. PATENT DOCUMENTS

542,029	A	*	7/1895	Rigby	248/80
916,255	A	*	3/1909	Barrows	248/80
1,508,535	A	*	9/1924	Rottenburg	248/153
1,590,910	A	*	6/1926	Rumrill	248/80
2,216,255	A	*	10/1940	Tate	D8/71
2,760,668	A	*	8/1956	Wiederspan et al.	248/315
2,999,644	A	*	9/1961	Nobinger	248/80
3,054,588	A	*	9/1962	Ondrasik	248/175

D306,521	S	*	3/1990	Kenney	D8/71
4,979,759	A	*	12/1990	Solovay	248/175
5,002,246	A	*	3/1991	Chaffin et al.	248/153
5,169,007	A	*	12/1992	McHendry	248/309.1
D334,492	S	*	4/1993	Morello	D8/71
D440,477	S	*	4/2001	Pappas	D8/71

* cited by examiner

Primary Examiner—Doris V. Coles

Assistant Examiner—T. Chase Nelson

(74) *Attorney, Agent, or Firm*—Rosenberg, Klein & Lee

(57) **CLAIM**

The ornamental design for a standing device for a spray gun, as shown and described.

DESCRIPTION

FIG. 1 is a perspective view of a standing device for a spray gun showing my new design;
 FIG. 2 is a front elevational view thereof;
 FIG. 3 is a rear elevational view thereof;
 FIG. 4 is a left side view thereof;
 FIG. 5 is a right side view thereof;
 FIG. 6 is a top plan view thereof;
 FIG. 7 is a bottom plan view thereof;
 FIG. 8 is a reduced scale view showing the application thereof, wherein the broken line portion is for illustrative purpose only and forms no part of the claimed design; and,
 FIG. 9 is a reduced scale view showing the application thereof, wherein the broken line portion is for illustrative purpose only and forms no part of the claimed design.

1 Claim, 9 Drawing Sheets

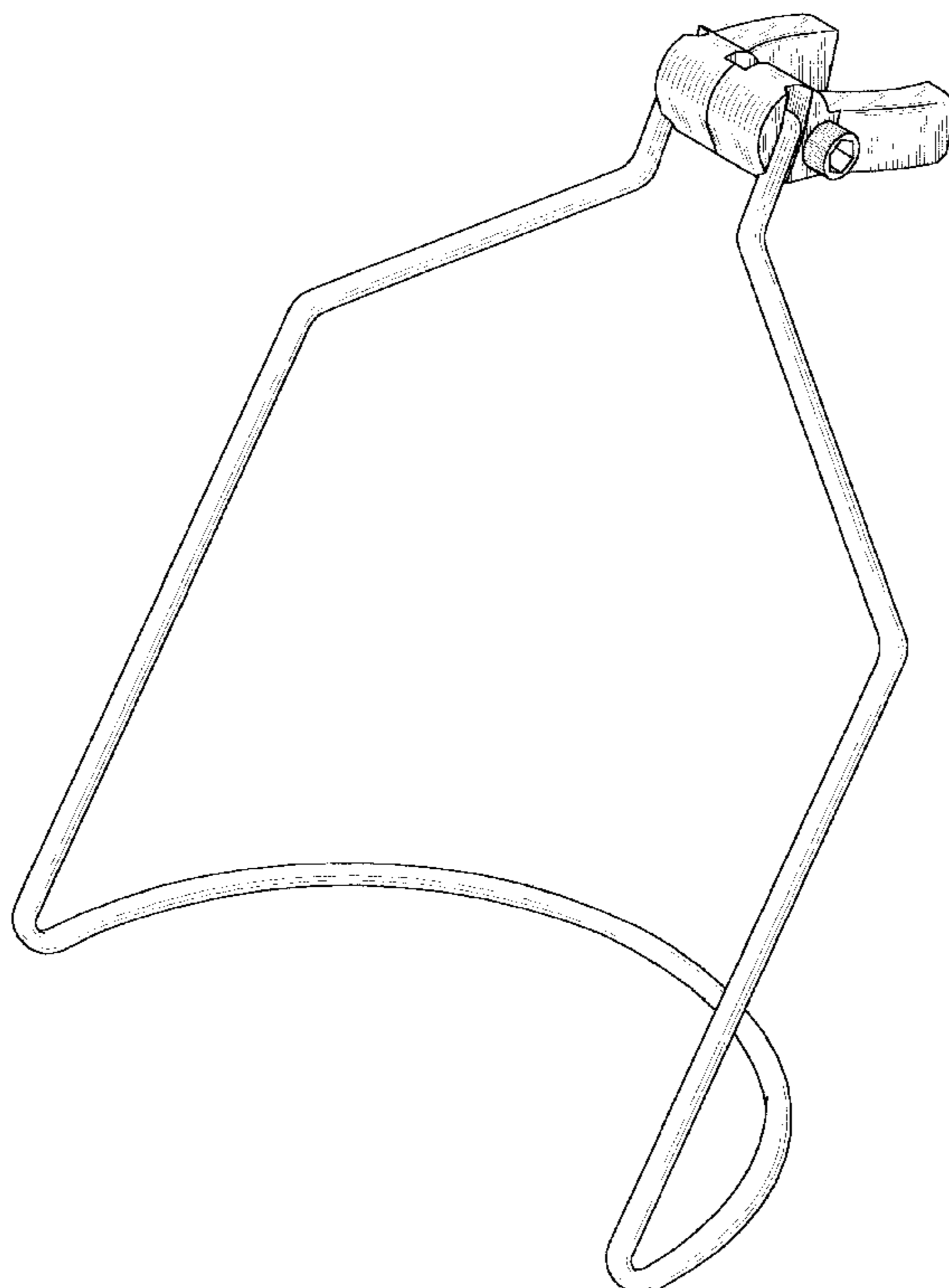

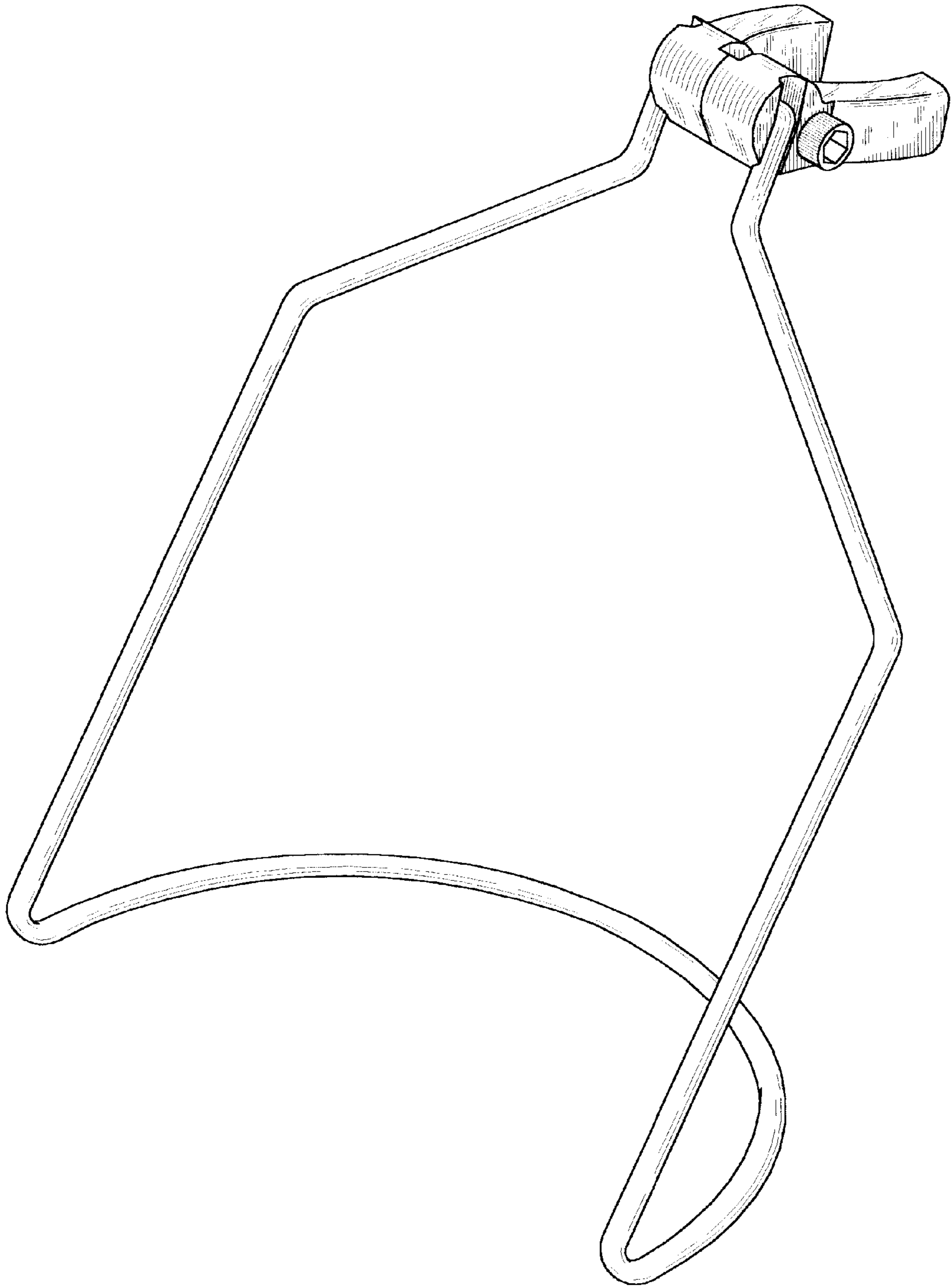

FIG. 1

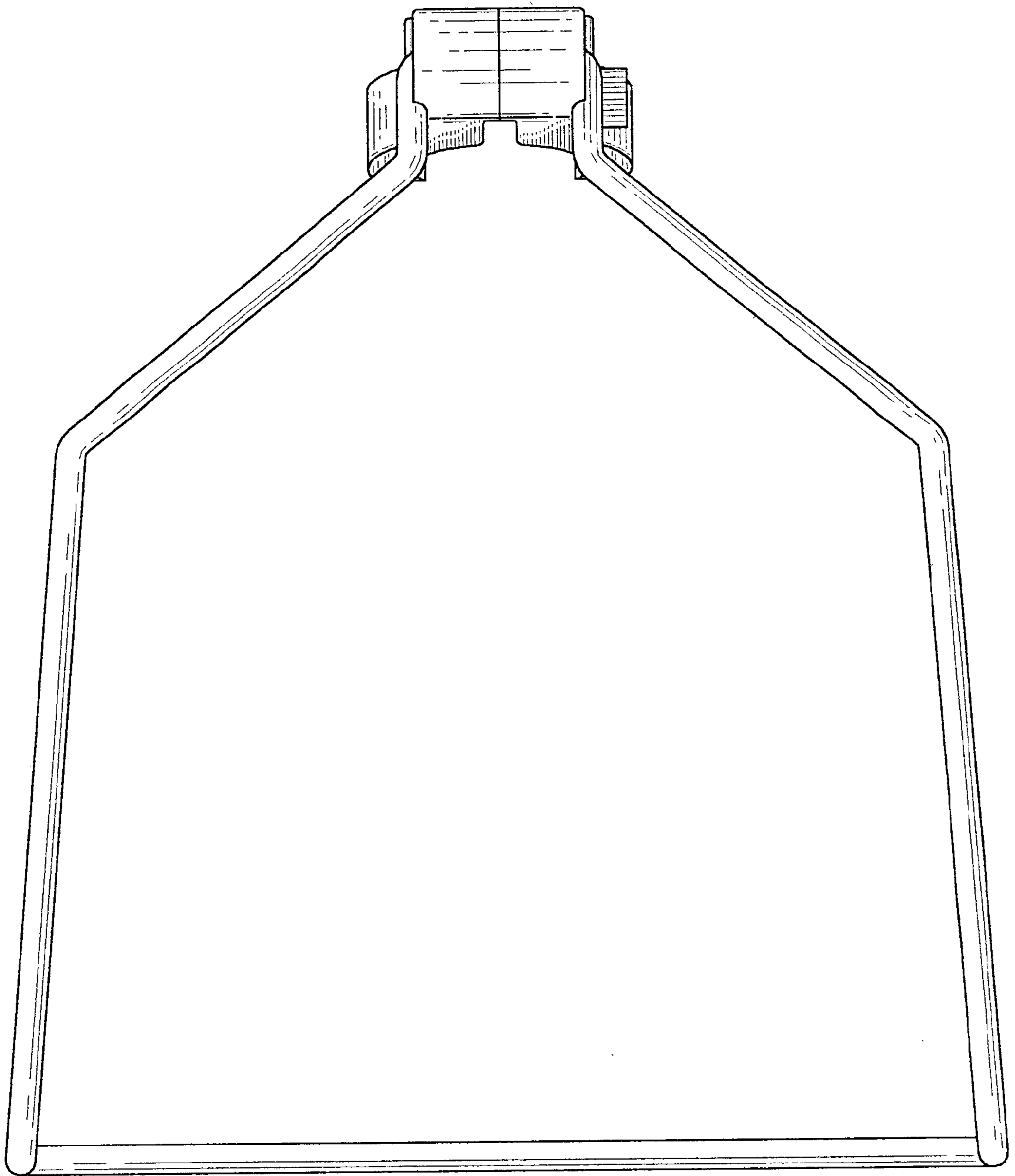

FIG. 2

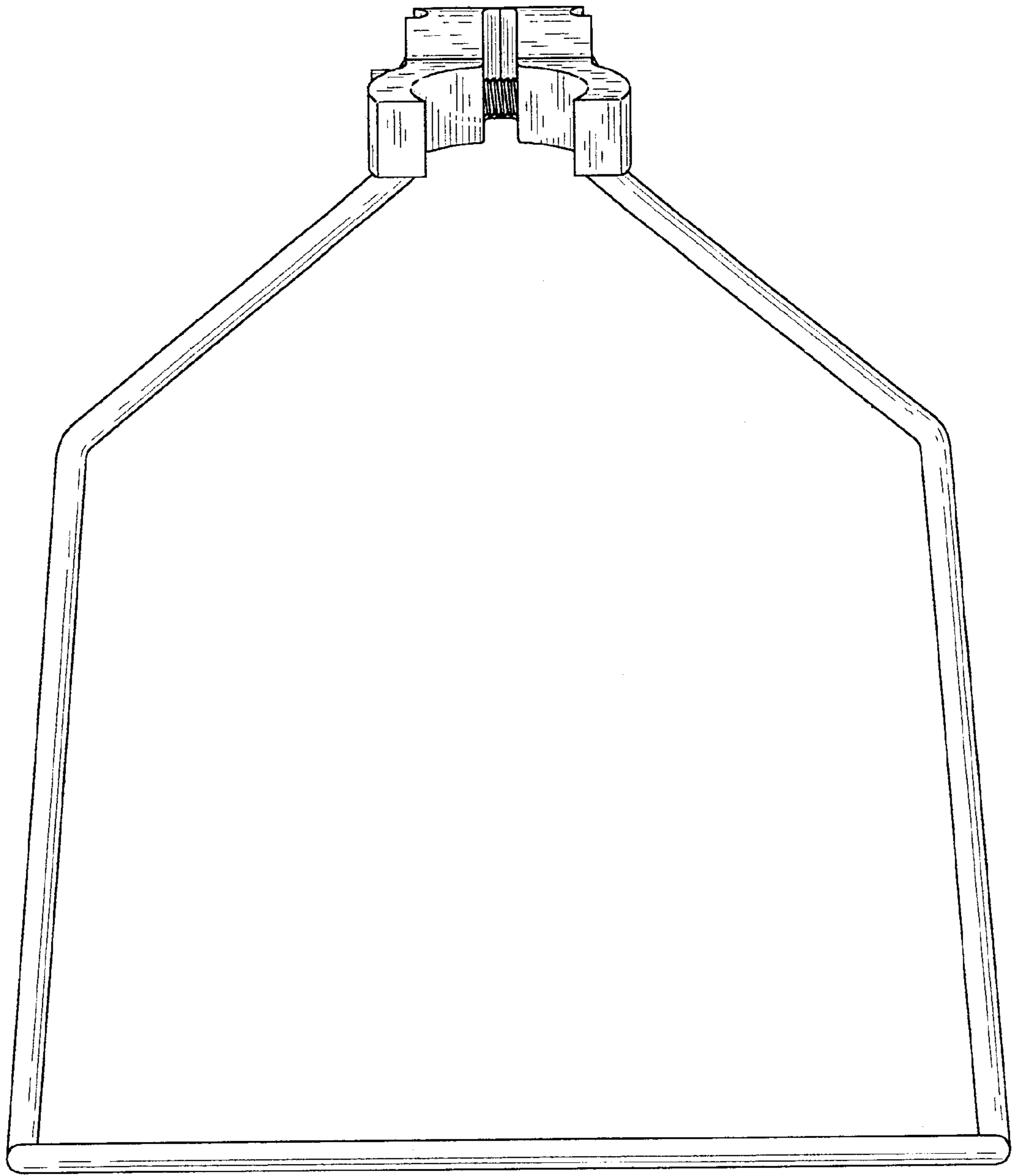

FIG. 3

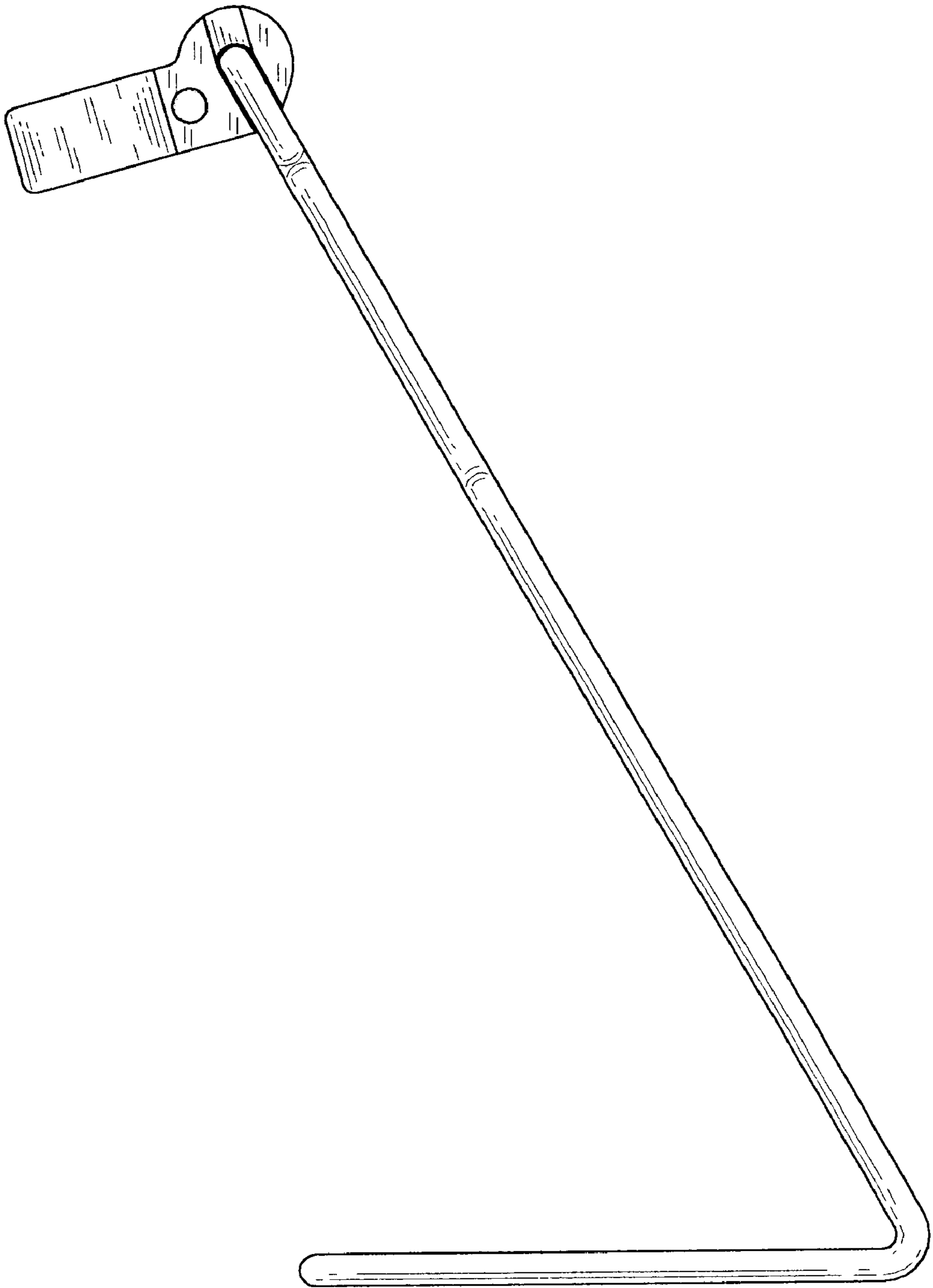

FIG. 4

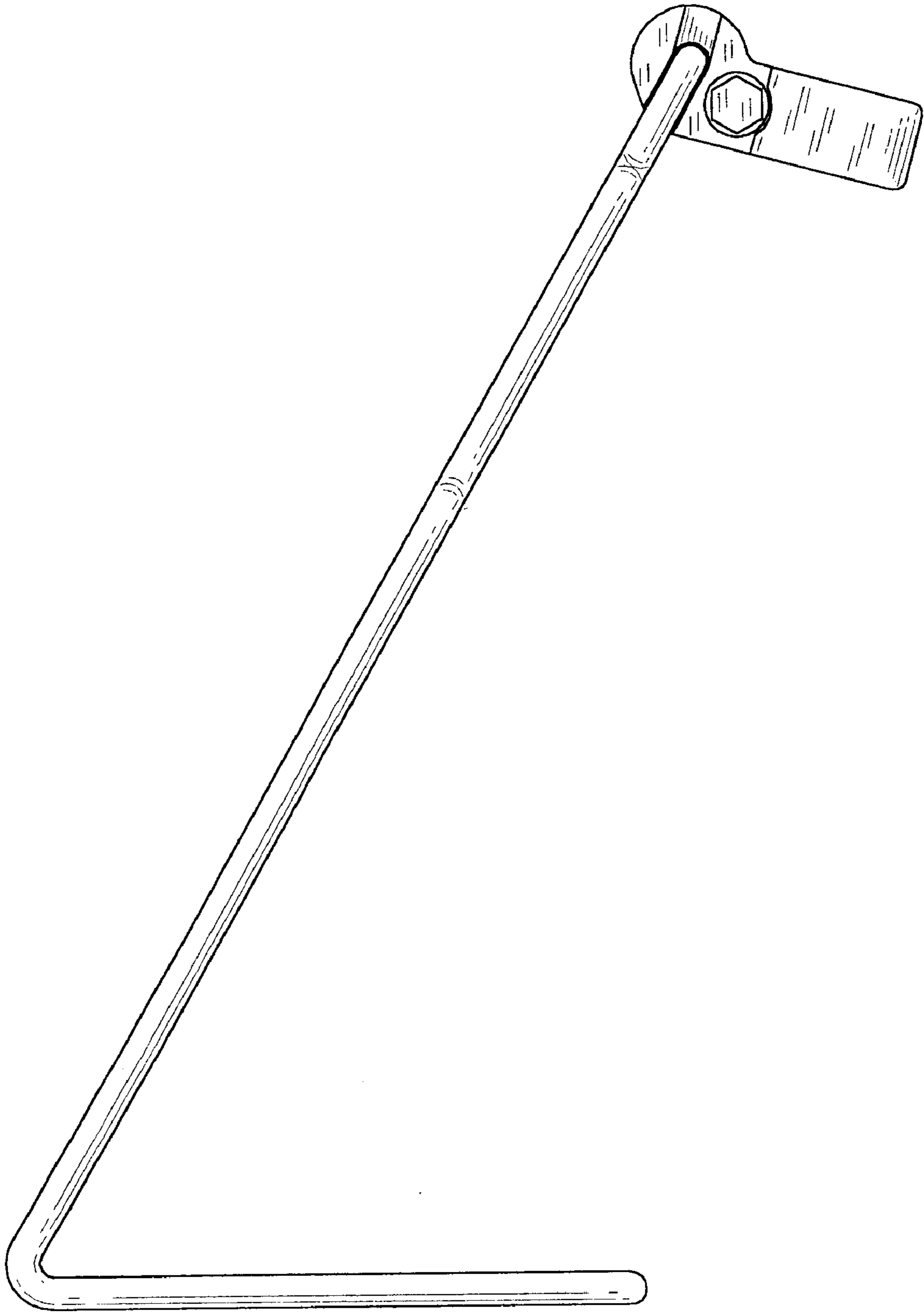

FIG. 5

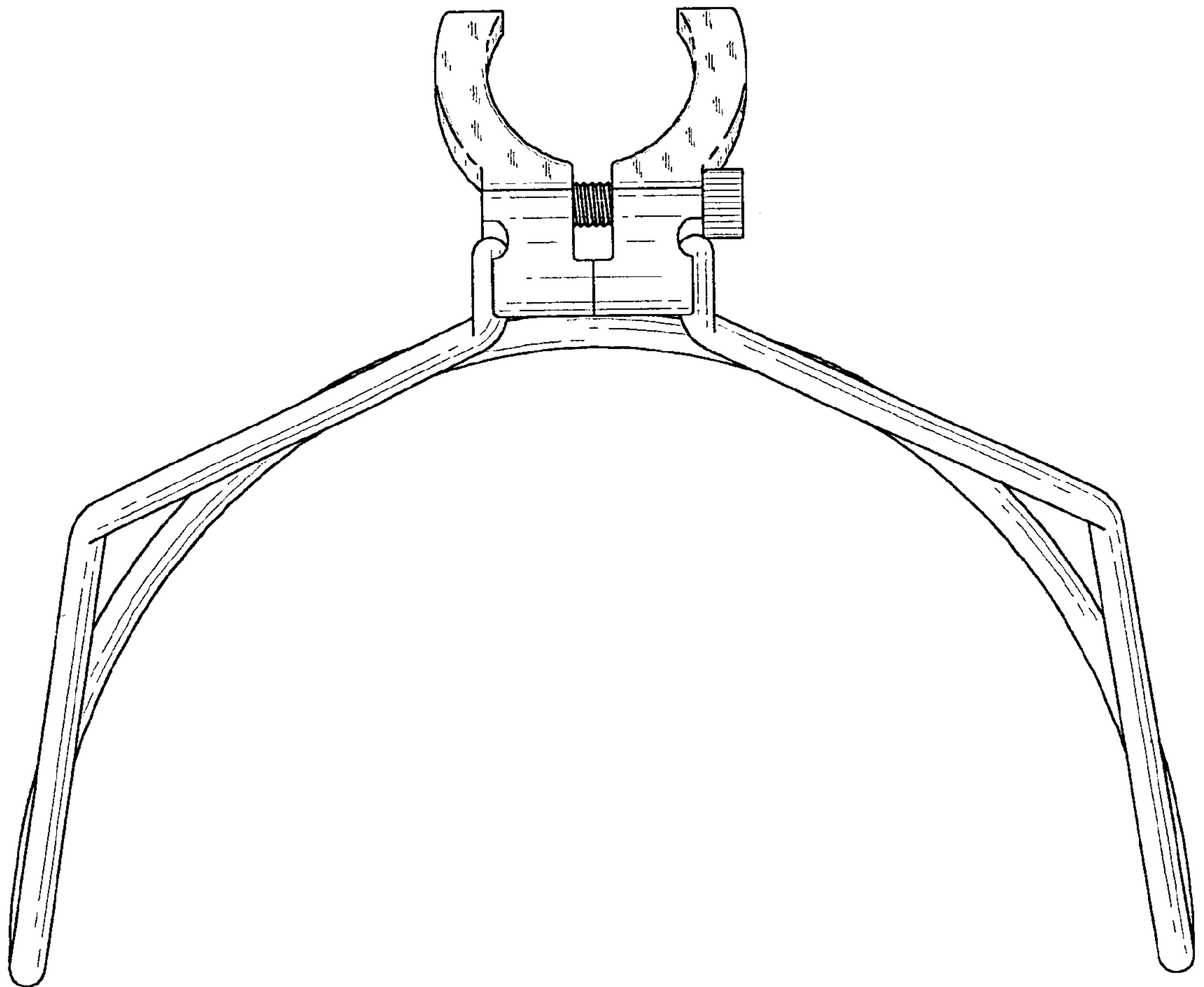

FIG. 6

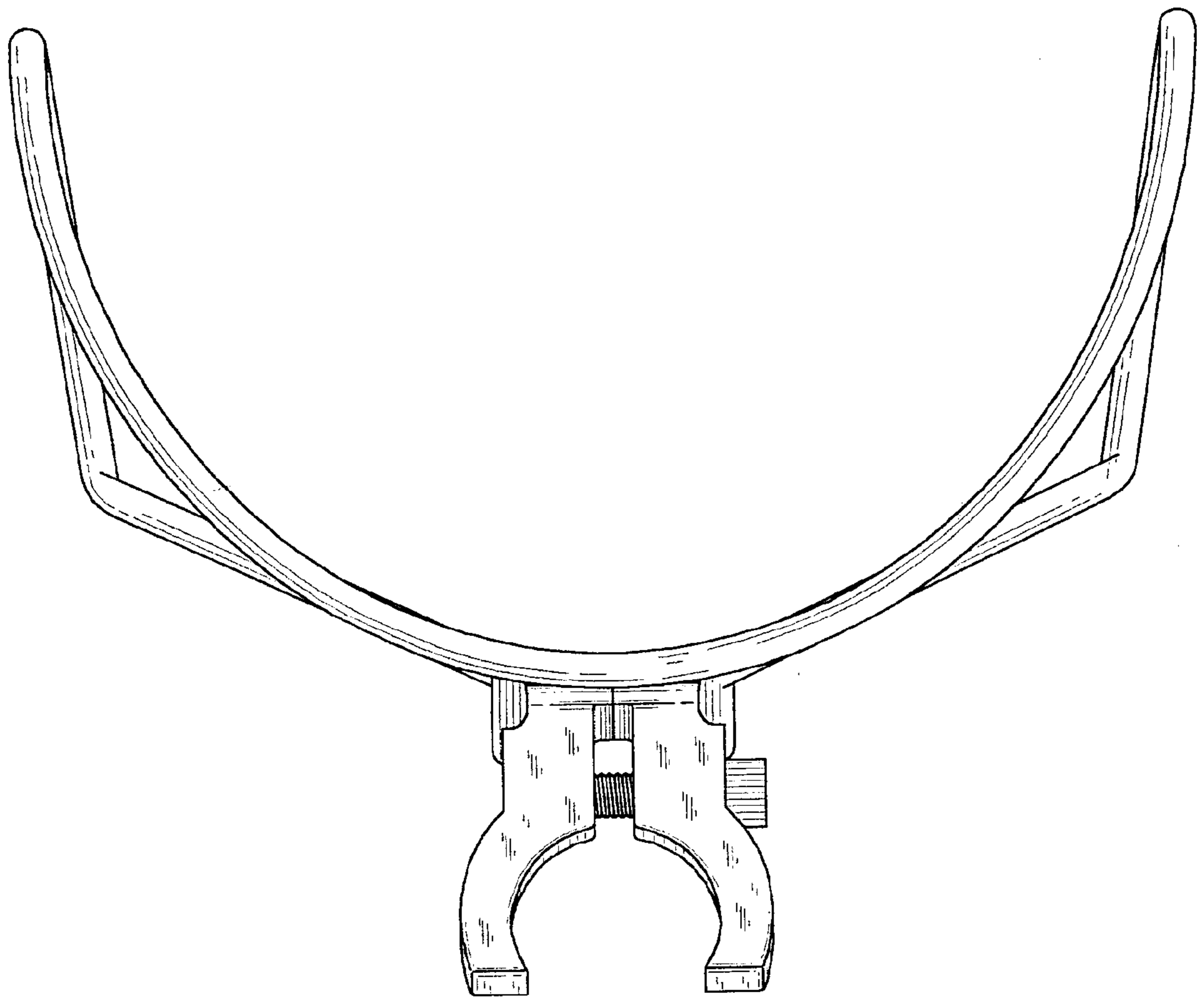

FIG. 7

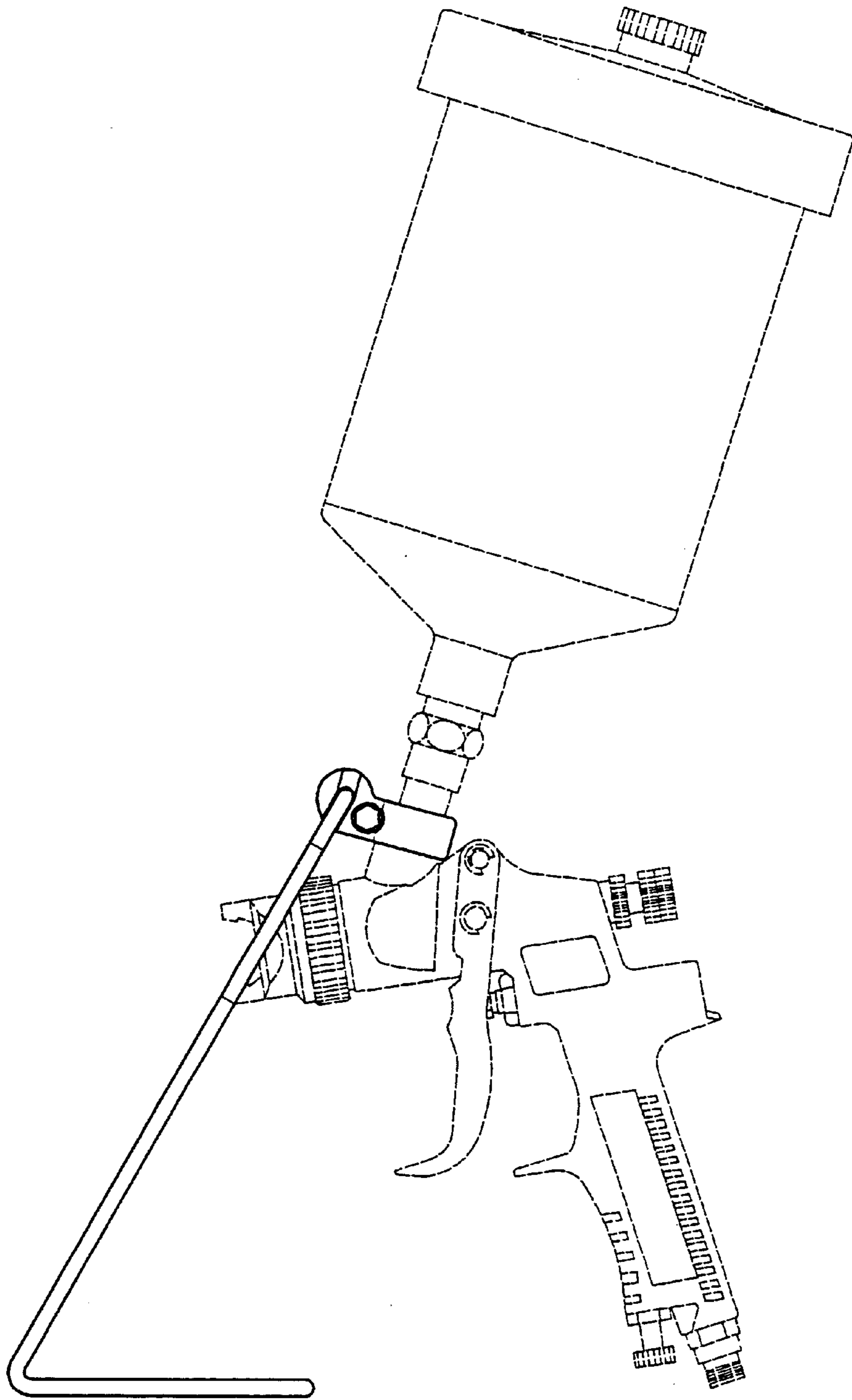

FIG. 8

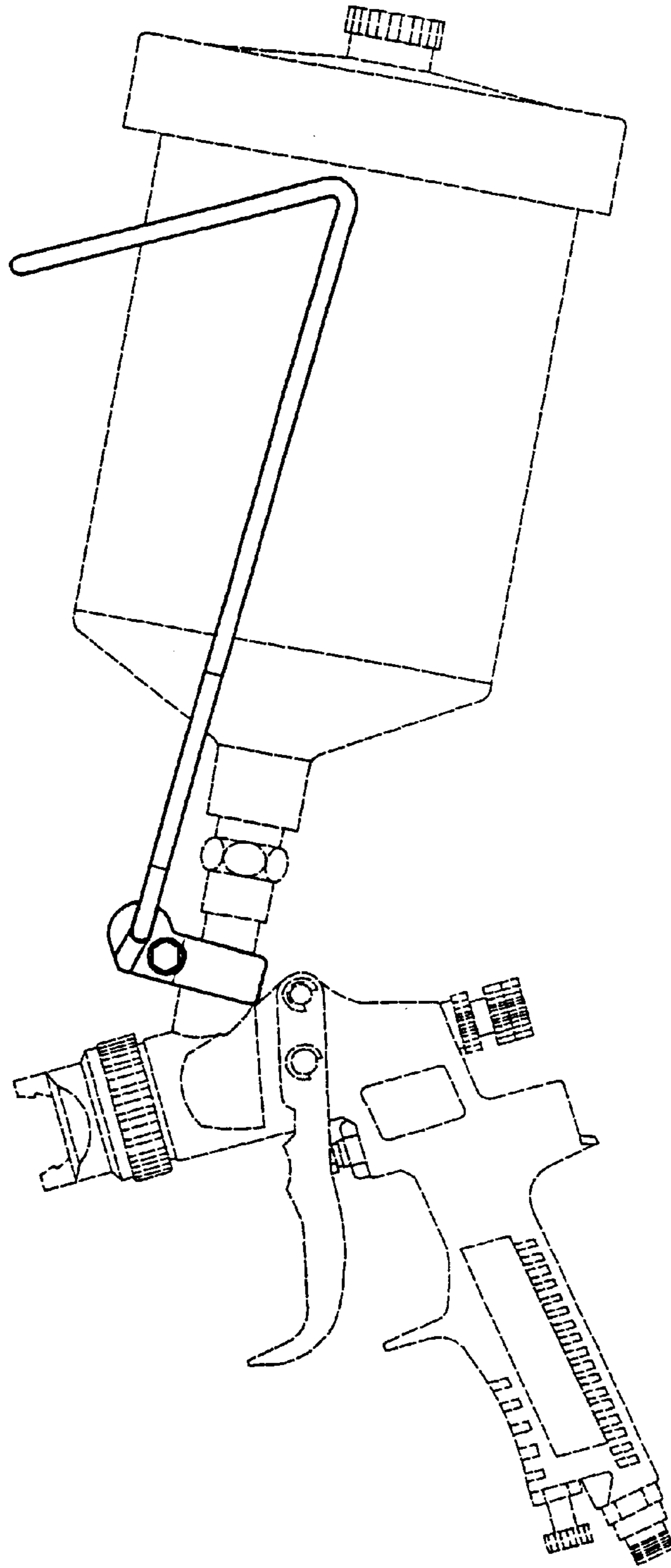

FIG. 9