



US00D488929S

(12) **United States Design Patent**
Nordstrom et al.

(10) **Patent No.:** **US D488,929 S**

(45) **Date of Patent:** **** Apr. 27, 2004**

(54) **SHOULDER STRAP SET FOR A BACKPACK**

2003/0160080 A1 * 8/2003 Nordstrom 224/264

(75) Inventors: **Mark B. Nordstrom**, Brentwood, TN
(US); **Cory O. Nykoluk**, St. Louis, MO
(US)

* cited by examiner

(73) Assignee: **TRG Accessories, LLC**, St. Louis, MO
(US)

Primary Examiner—Louis S. Zarfes
Assistant Examiner—Monica A. Weingart
(74) *Attorney, Agent, or Firm*—Lewis, Rice & Fingersh LC

(**) Term: **14 Years**

(57) **CLAIM**

The ornamental design of shoulder strap set for a backpack,
as shown and described.

(21) Appl. No.: **29/168,865**

DESCRIPTION

(22) Filed: **Oct. 10, 2002**

(51) **LOC (7) Cl.** **03-01**

(52) **U.S. Cl.** **D3/327**

(58) **Field of Search** D3/216, 217, 279,
D3/318, 327; 2/94; 24/170, 200; 150/108,
110; 190/102, 110, 111, 115; 383/97, 119;
224/153, 155, 254, 257, 259, 264, 578,
579, 627, 643, 645, 653, 913; 280/814;
297/188.06

FIG. 1 provides a perspective view of the shoulder strap set
for a backpack.

FIG. 2 provides a front view of the shoulder strap set for a
backpack.

FIG. 3 provides a back view of the shoulder strap set for a
backpack.

FIG. 4 provides a right side view of the shoulder strap set for
a backpack.

FIG. 5 provides a left side view of the shoulder strap set for
a backpack.

FIG. 6 provides a top view of the shoulder strap set for a
backpack; and,

FIG. 7 provides a bottom view of the shoulder strap set for
a backpack.

The broken line showing of a backpack, in the views, is for
illustrative purposes only and forms no part of the claimed
design.

(56) **References Cited**

U.S. PATENT DOCUMENTS

995,458	A	*	6/1911	Harriman	224/645
5,240,159	A	*	8/1993	Gregory	224/264
5,553,759	A	*	9/1996	McMaster et al.	224/264
6,095,389	A		8/2000	Fenton et al.		
D457,307	S	*	5/2002	Pukall et al.	D3/216
D479,648	S	*	9/2003	De Lathouwer	D3/216

1 Claim, 7 Drawing Sheets

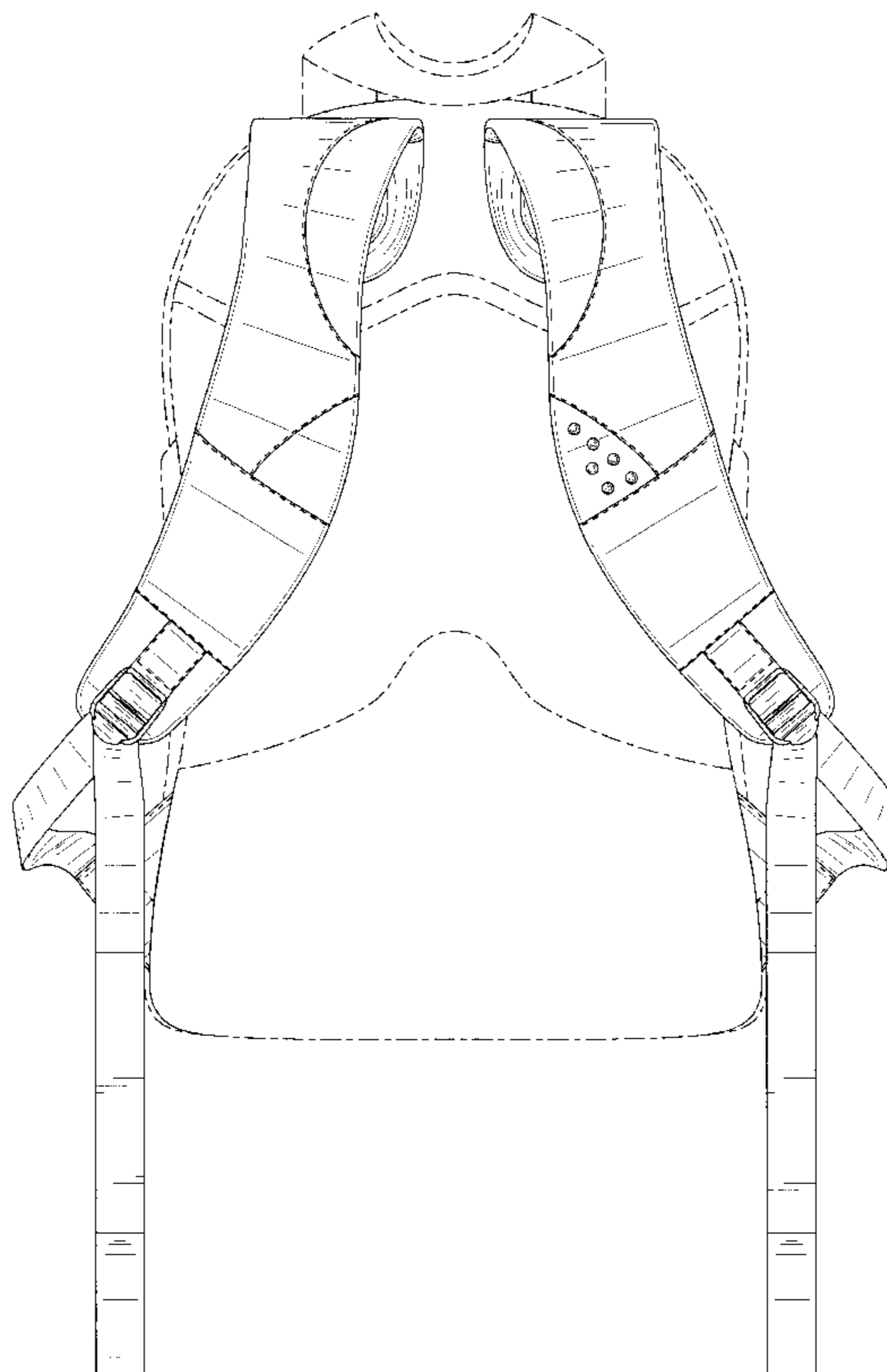

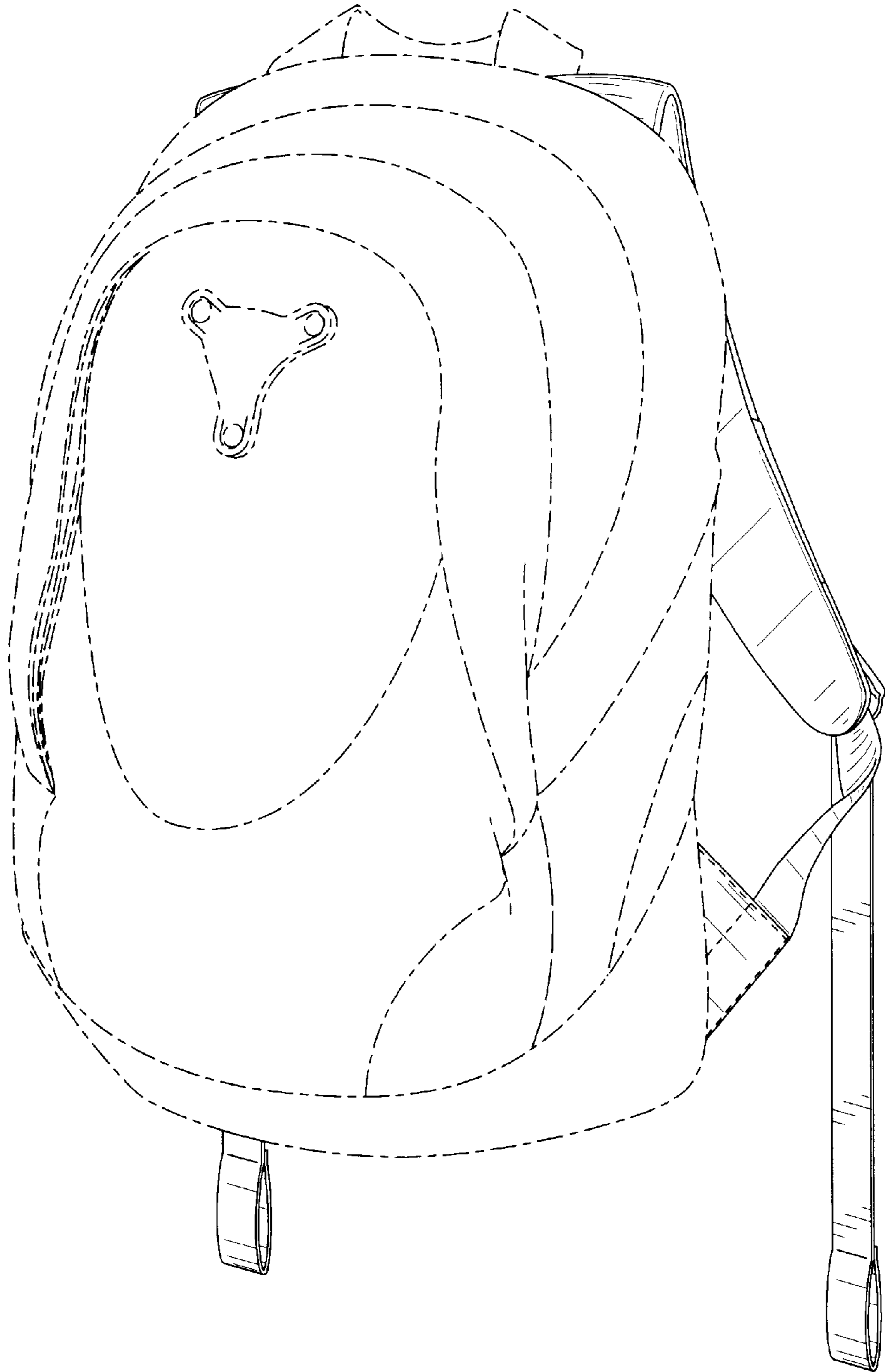

FIG. 1

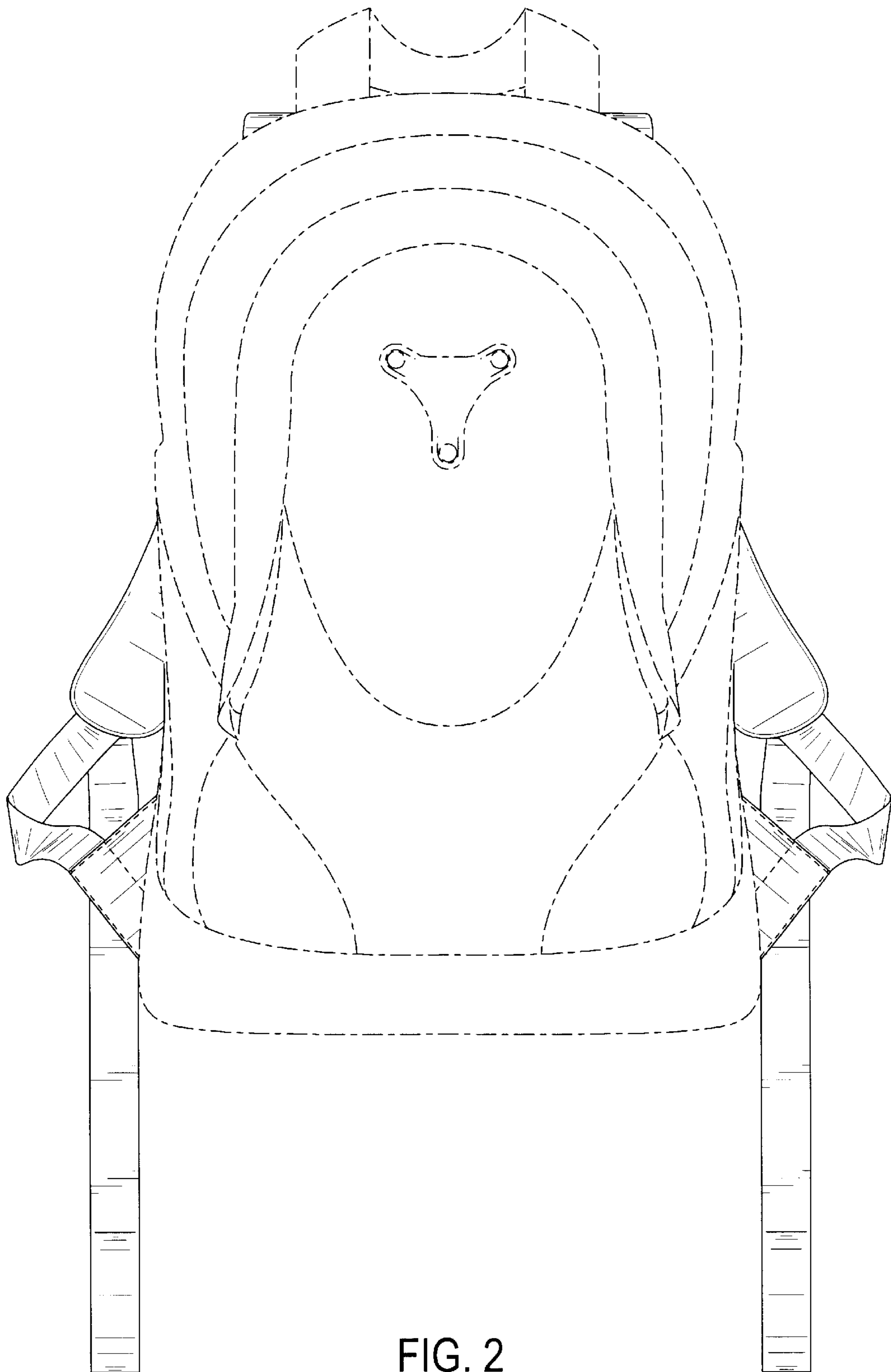

FIG. 2

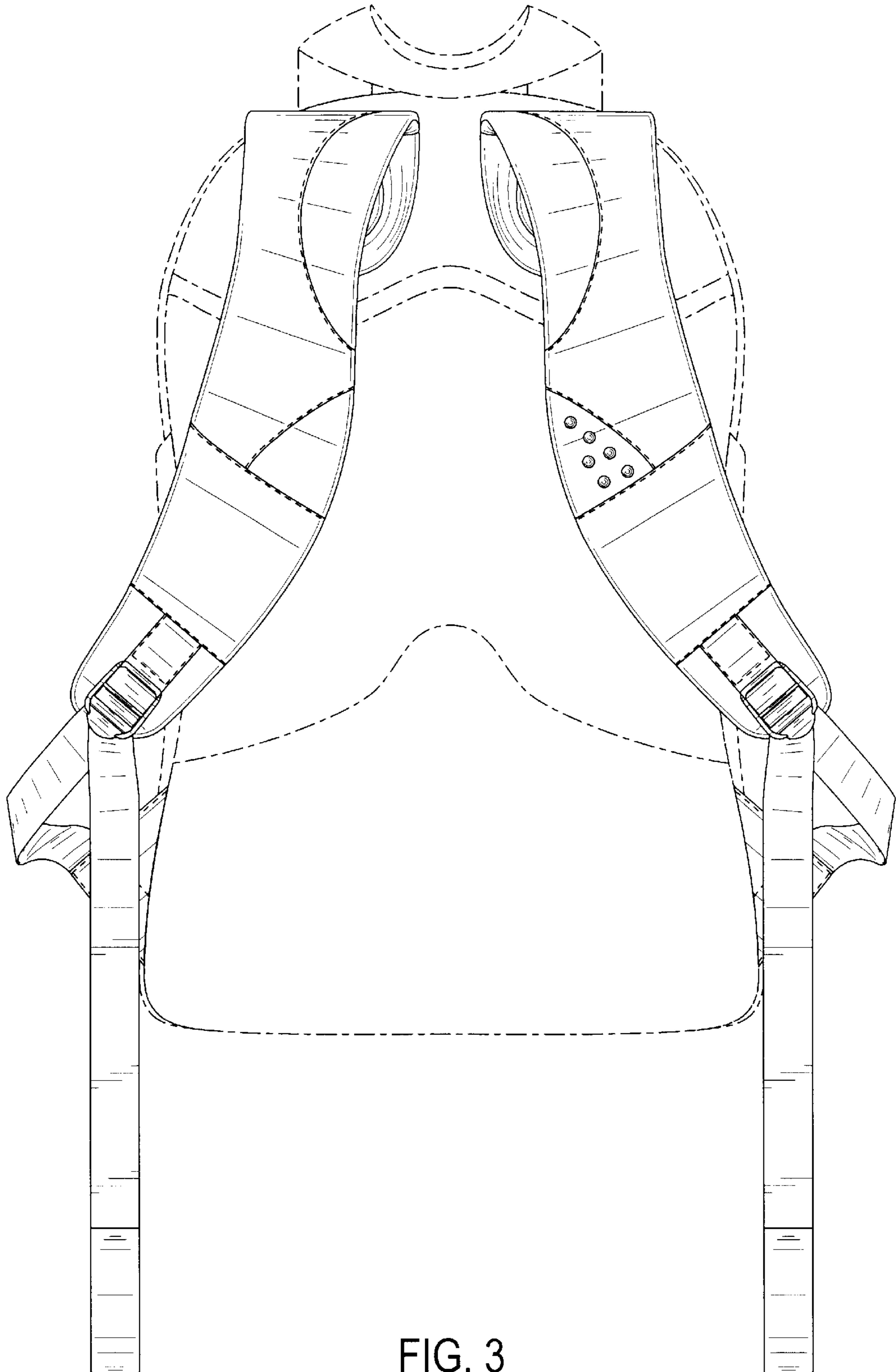

FIG. 3

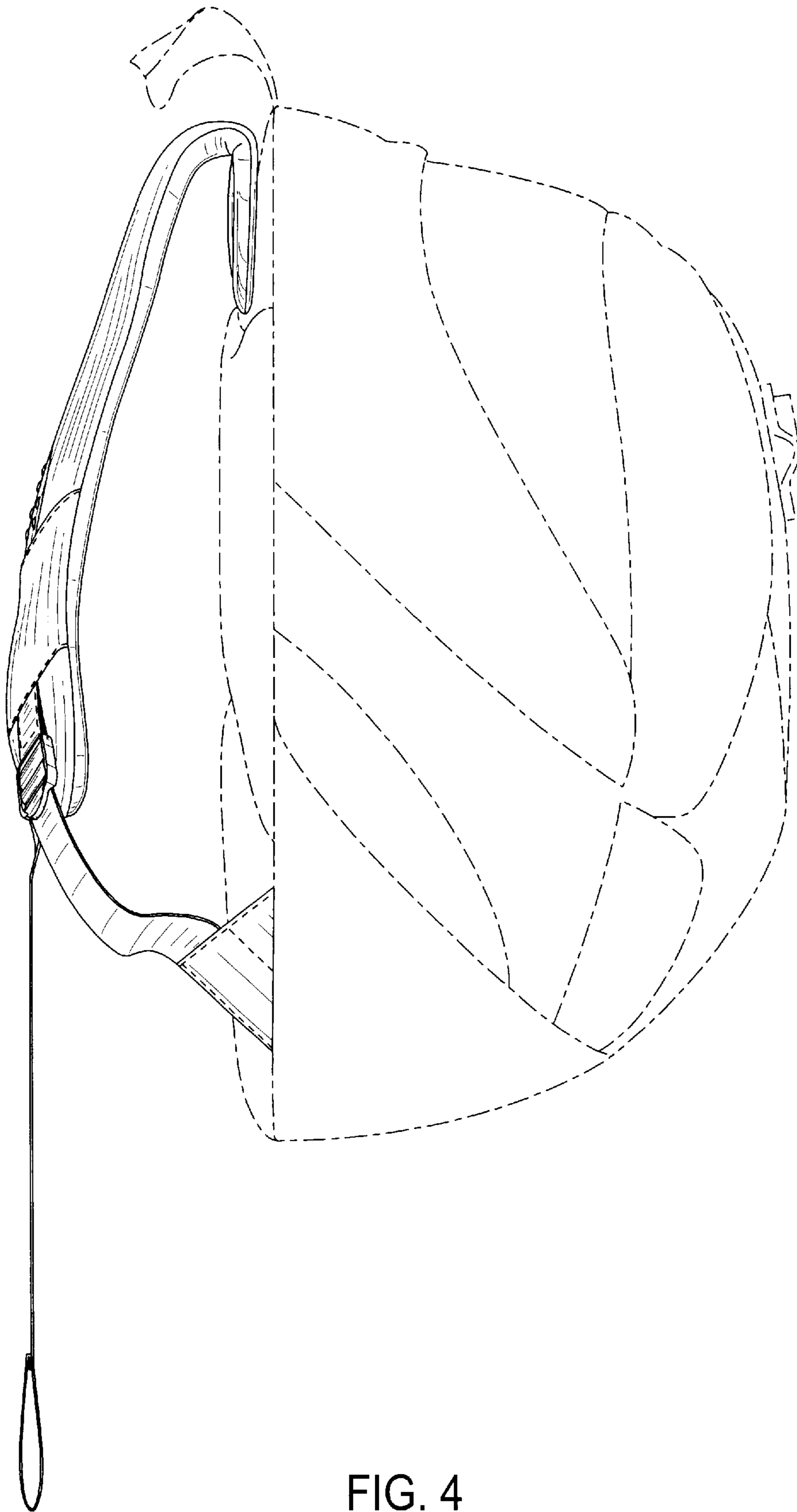

FIG. 4

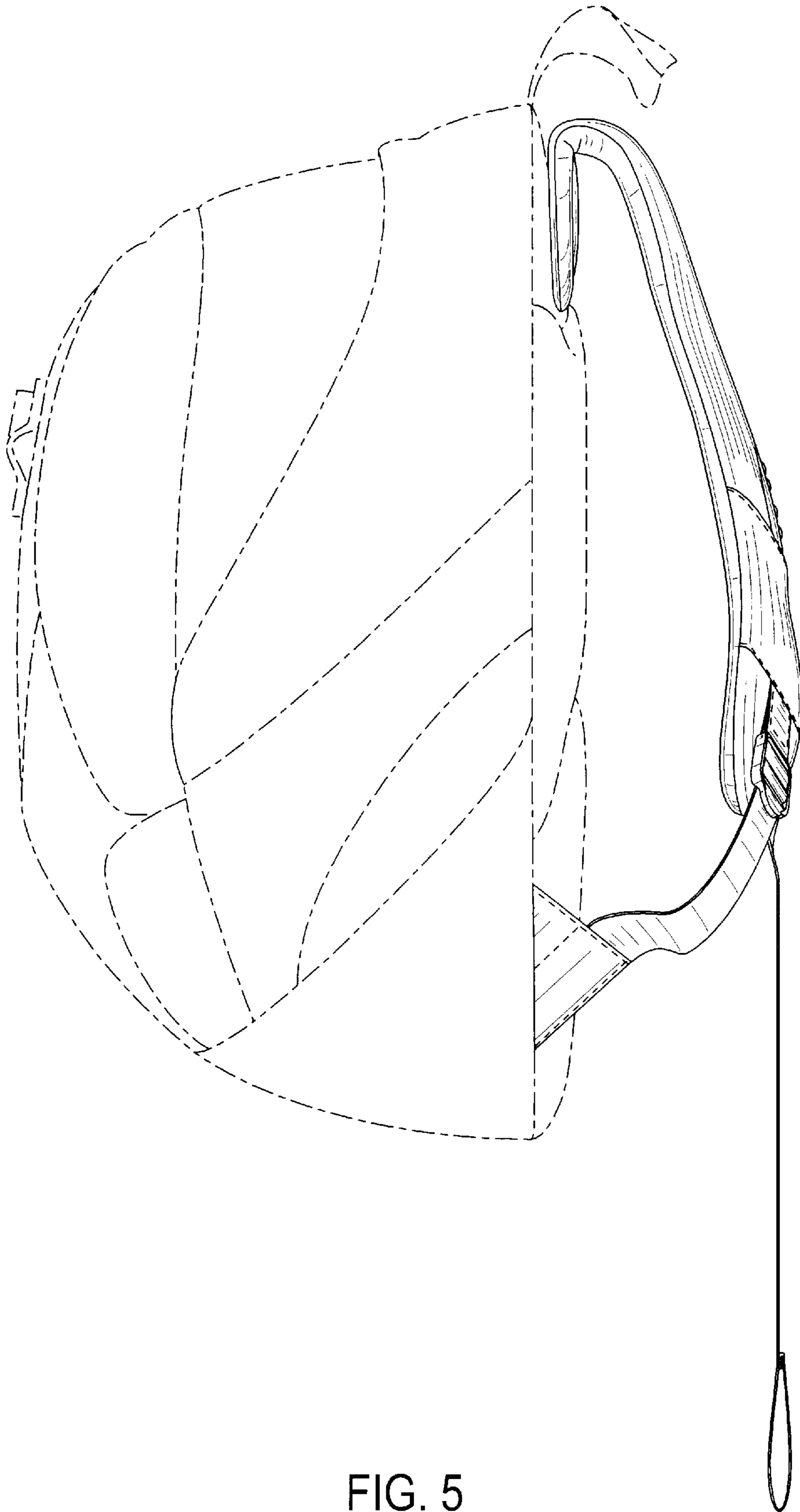

FIG. 5

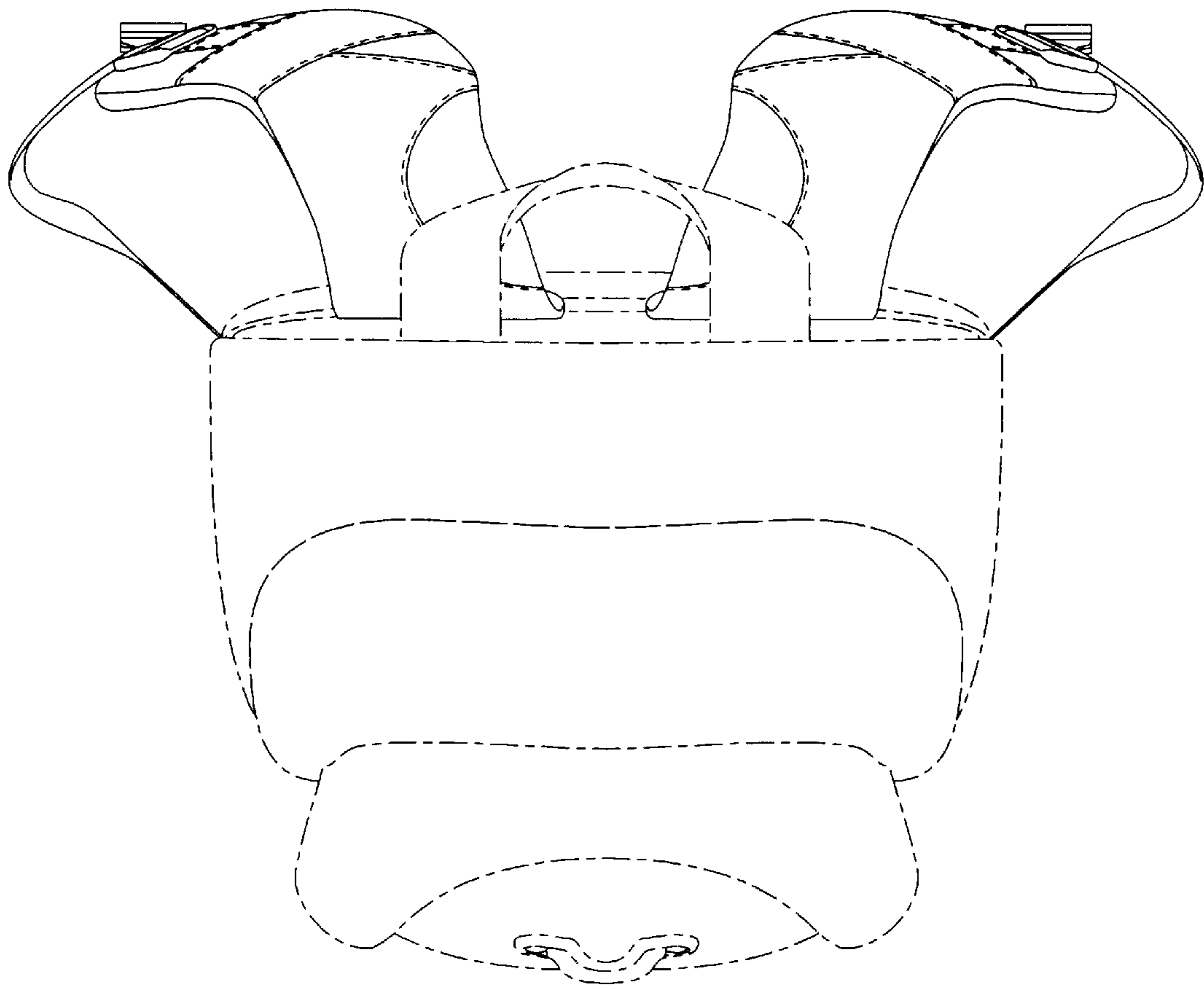

FIG. 6

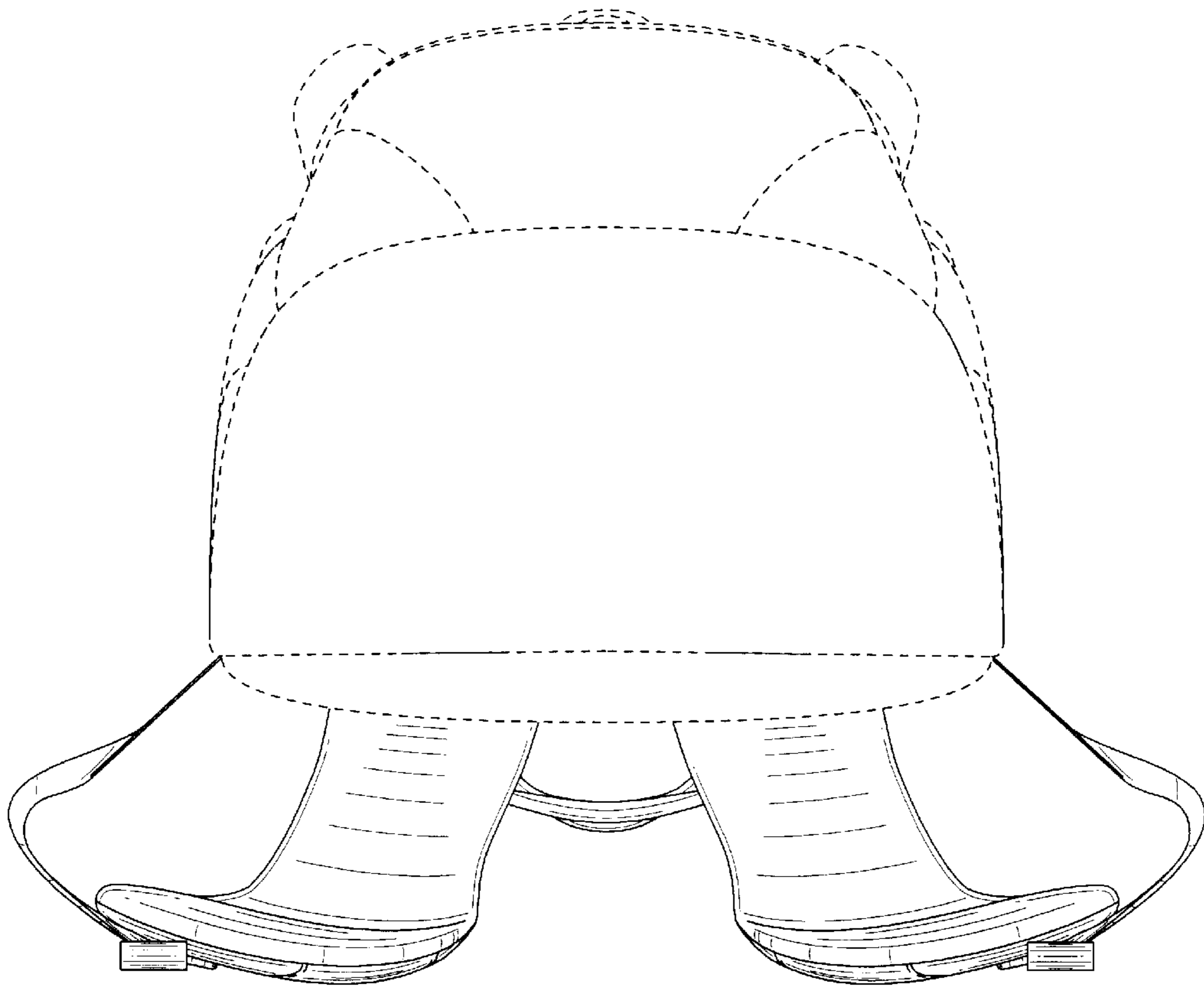

FIG. 7