



US00D488911S

(12) **United States Design Patent**  
**Childress**

(10) **Patent No.:** **US D488,911 S**

(45) **Date of Patent:** **\*\* Apr. 27, 2004**

(54) **CURVED BODY OF CHEESE MADE OF  
OFFSET CURVED SLICES OF CHEESE**

(75) Inventor: **Dennis J. Childress**, Monett, MO (US)

(73) Assignee: **Schreiber Foods, Inc.**, Green Bay, WI (US)

(\*\*) Term: **14 Years**

(21) Appl. No.: **29/182,183**

(22) Filed: **May 21, 2003**

(51) **LOC (7) Cl.** ..... **01-01**

(52) **U.S. Cl.** ..... **D1/121; D1/199**

(58) **Field of Search** ..... D1/121, 199, 127,  
D1/128; 426/130, 115, 144, 106, 129; 206/449,  
499, 815, 555; 425/224; D21/386, 390

(56) **References Cited**

**U.S. PATENT DOCUMENTS**

2,907,109	A	*	10/1959	Palmer	.....	425/224
3,410,698	A	*	11/1968	Sosin	.....	426/106
4,046,923	A		9/1977	Meng et al.		
4,278,693	A	*	7/1981	Dingethal et al.	.....	426/129
4,427,705	A	*	1/1984	Wyslowsky et al.	.....	426/106
4,866,911	A	*	9/1989	Grindrod et al.	.....	53/432
6,299,919	B1	*	10/2001	Knaus et al.	.....	426/115

**OTHER PUBLICATIONS**

A picture of an elongated body of cheese comprising offset ribbons of cheese, undated.

\* cited by examiner

*Primary Examiner*—Pamela Burgess

(74) *Attorney, Agent, or Firm*—Brinks Hofer Gilson & Lione

(57) **CLAIM**

The ornamental design for a curved body of cheese made of offset curved slices of cheese, as shown and described.

**DESCRIPTION**

FIG. 1 is a curved body of cheese made of offset curved slices of cheese showing my new design;

FIG. 2 is a front elevational view thereof;

FIG. 3 is a first side elevational view thereof;

FIG. 4 is a rear elevational view thereof;

FIG. 5 is a second side elevational view thereof;

FIG. 6 is a top plan view thereof;

FIG. 7 is a bottom plan view thereof;

FIG. 8 is a second embodiment of a curved body of cheese made of offset curved slices of cheese showing my new design;

FIG. 9 is a third embodiment of a curved body of cheese made of offset curved slices of cheese showing my new design; and,

FIG. 10 is a fourth embodiment of a curved body of cheese made of offset curved slices of cheese showing my new design.

**1 Claim, 3 Drawing Sheets**

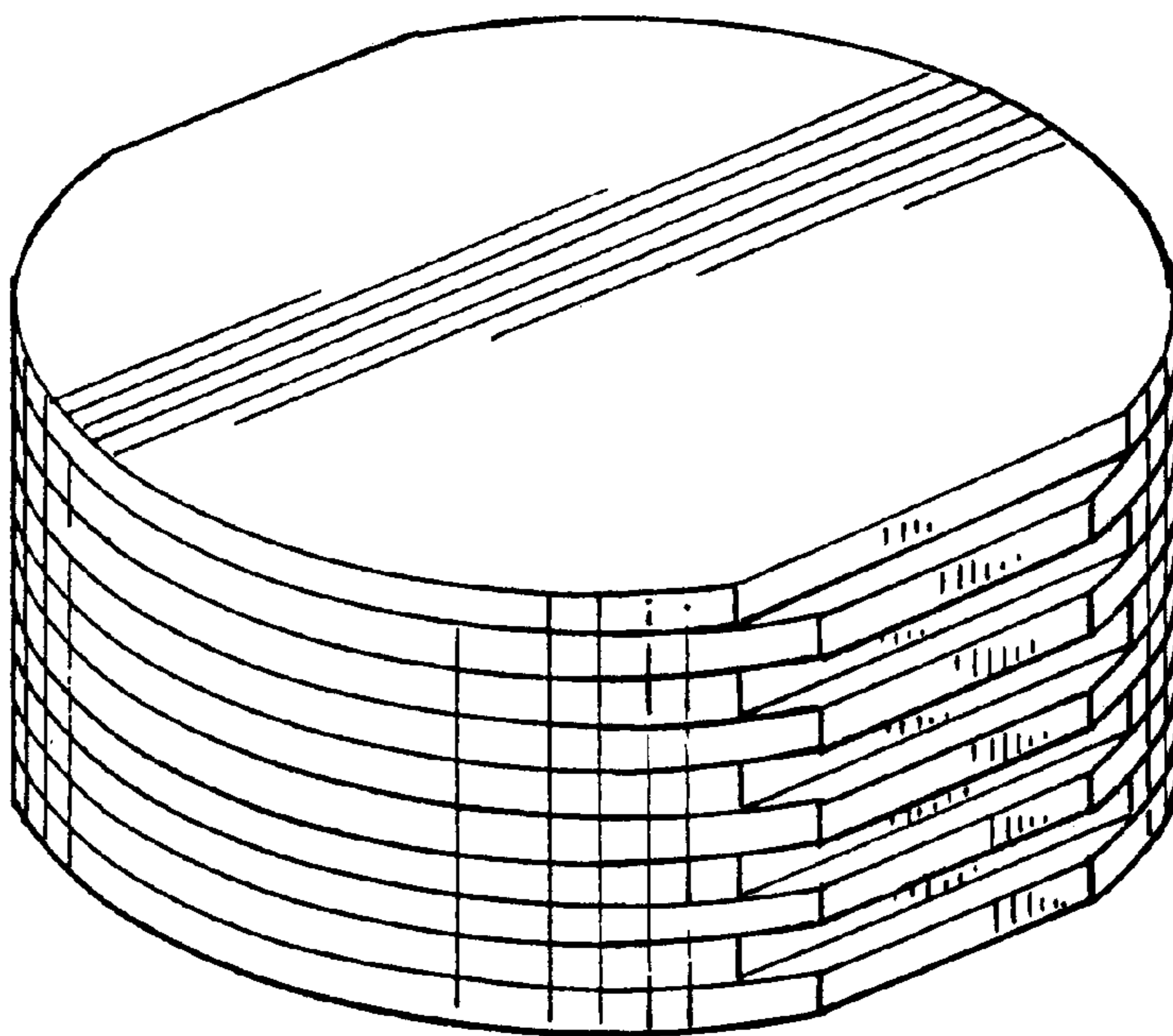

FIG.1

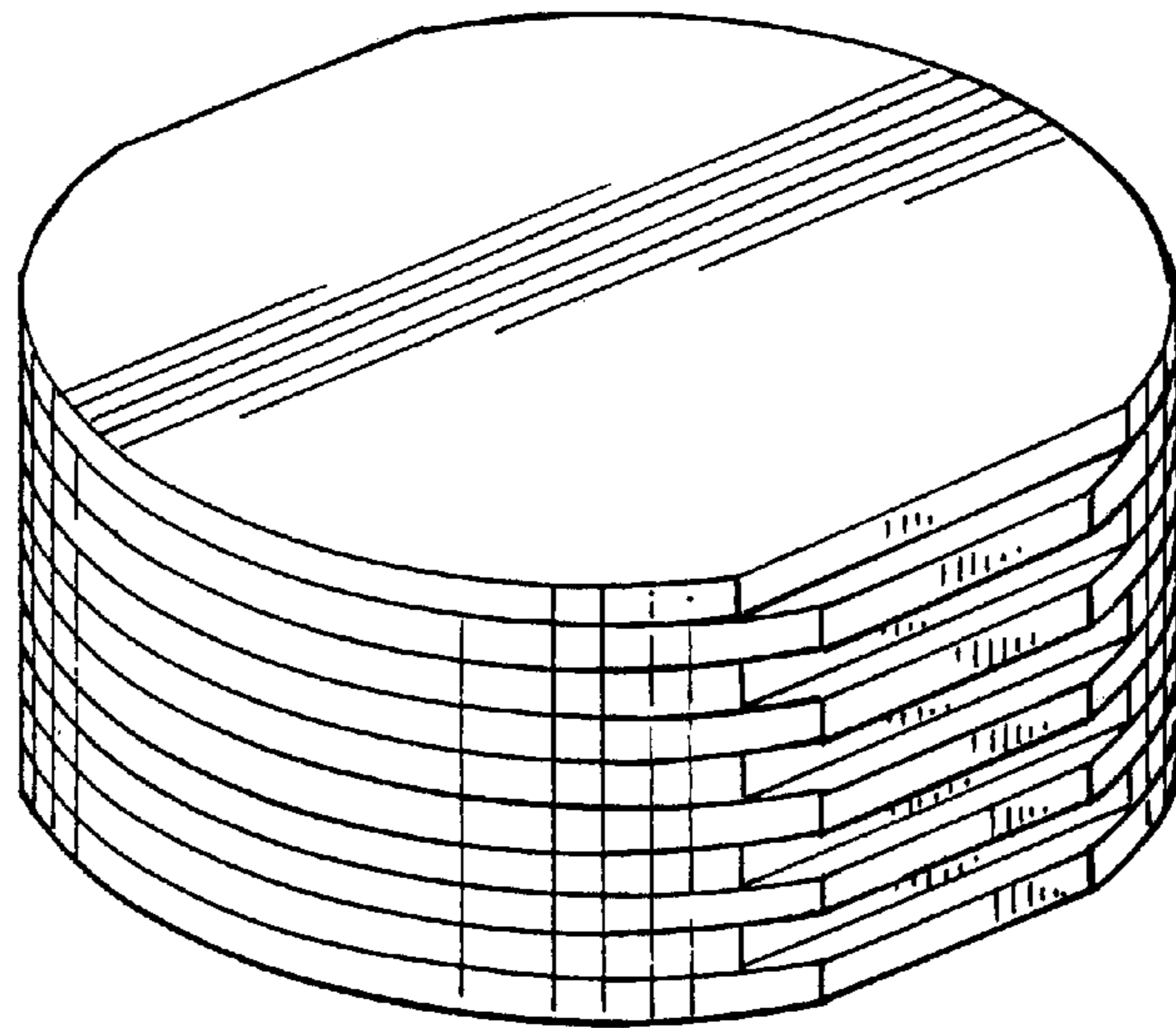

FIG.2

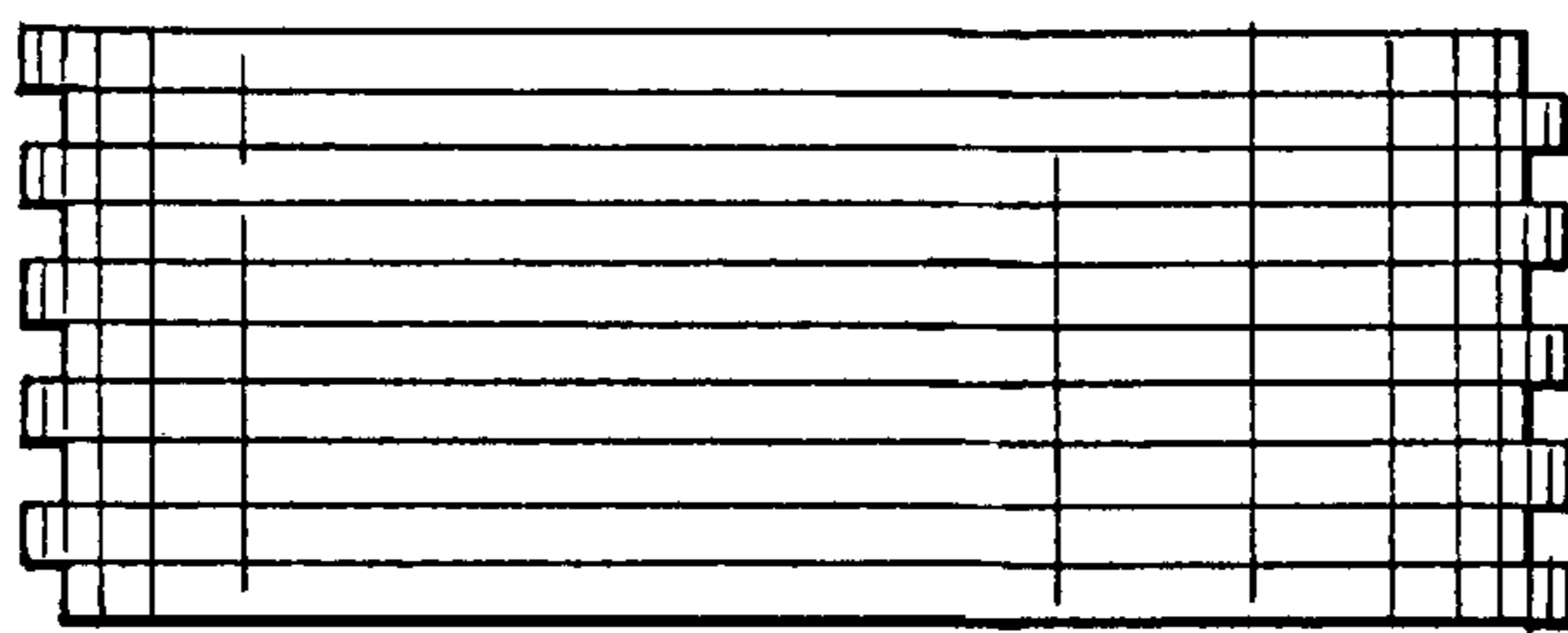

FIG.3

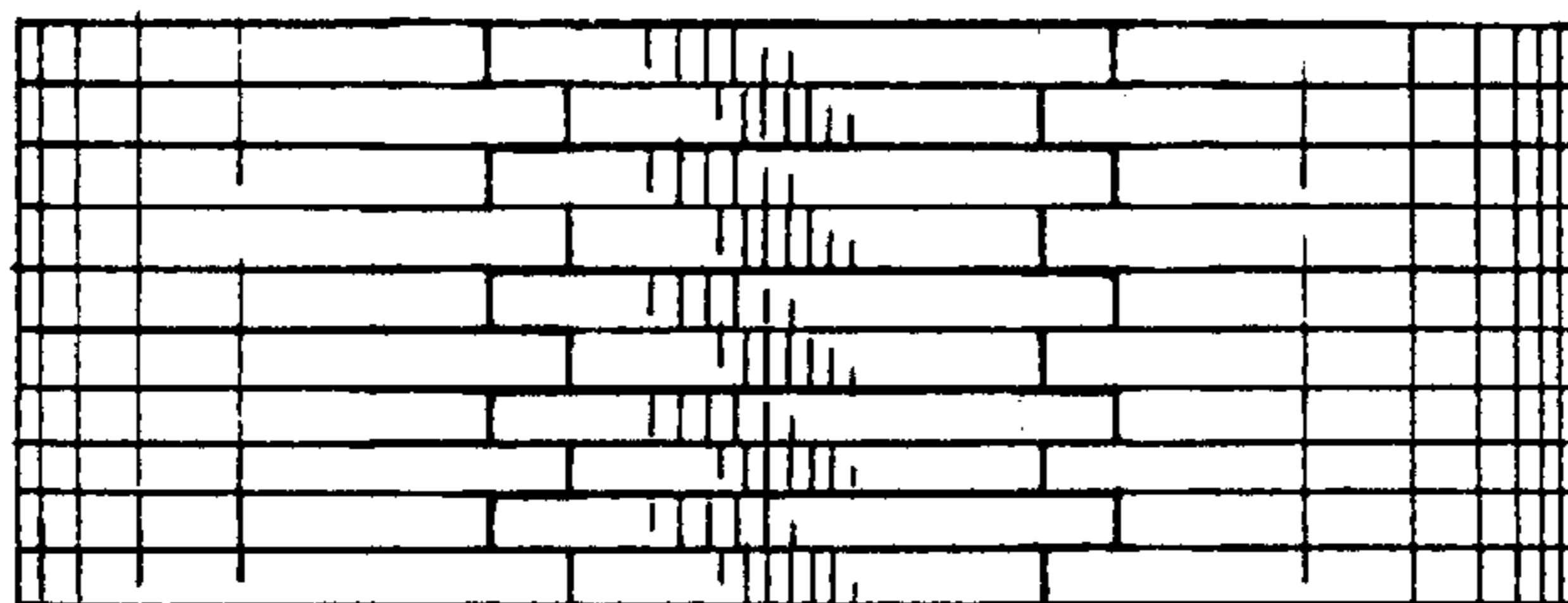

FIG.4

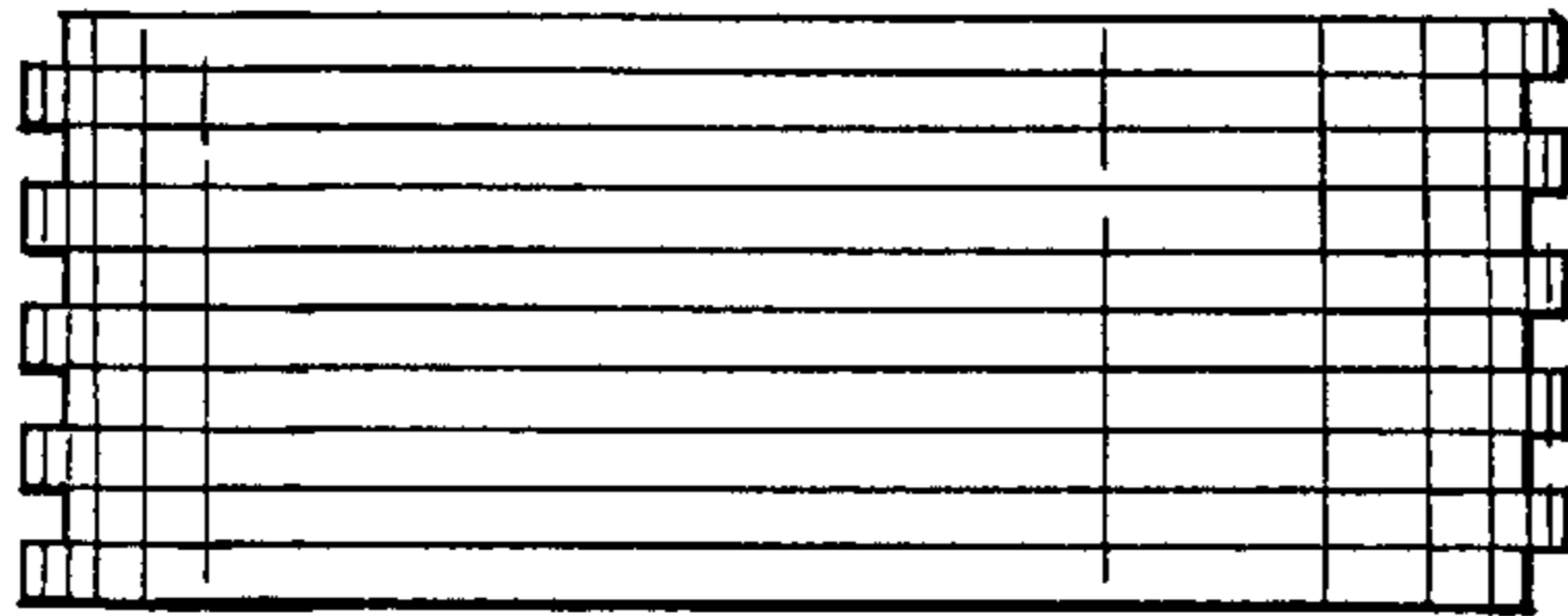

FIG.5

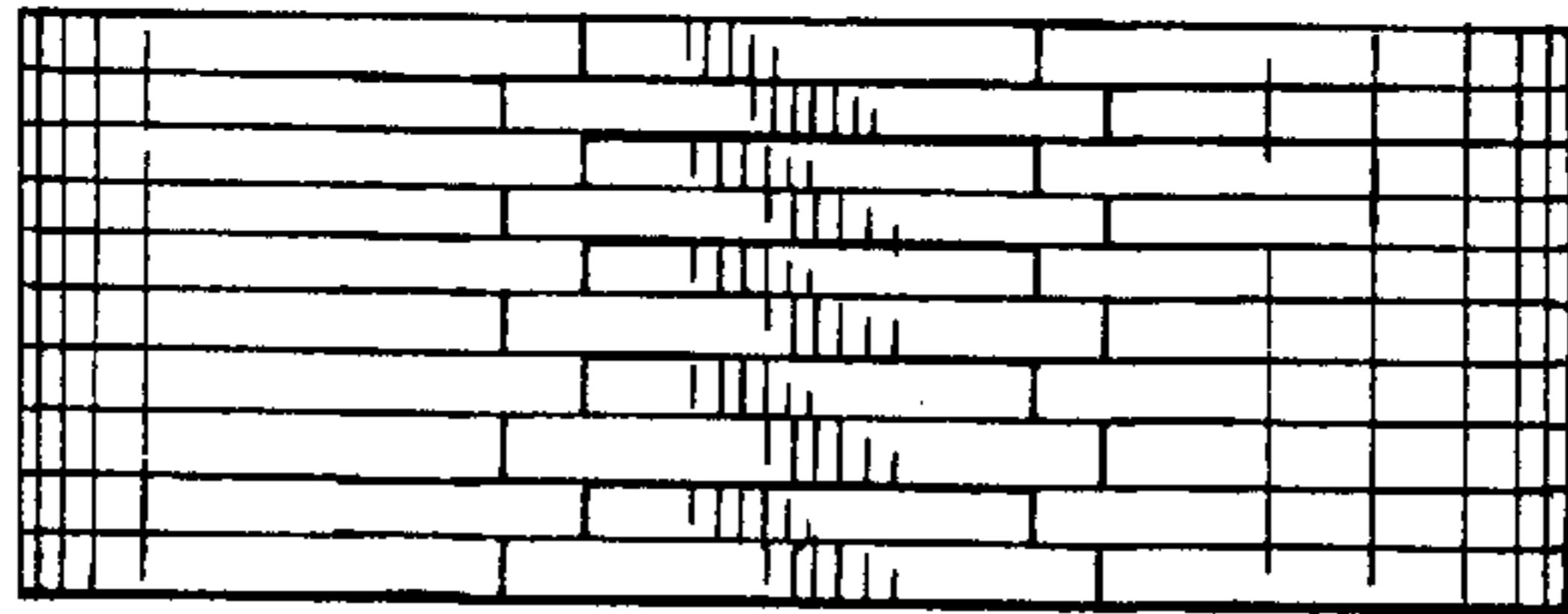

FIG.6

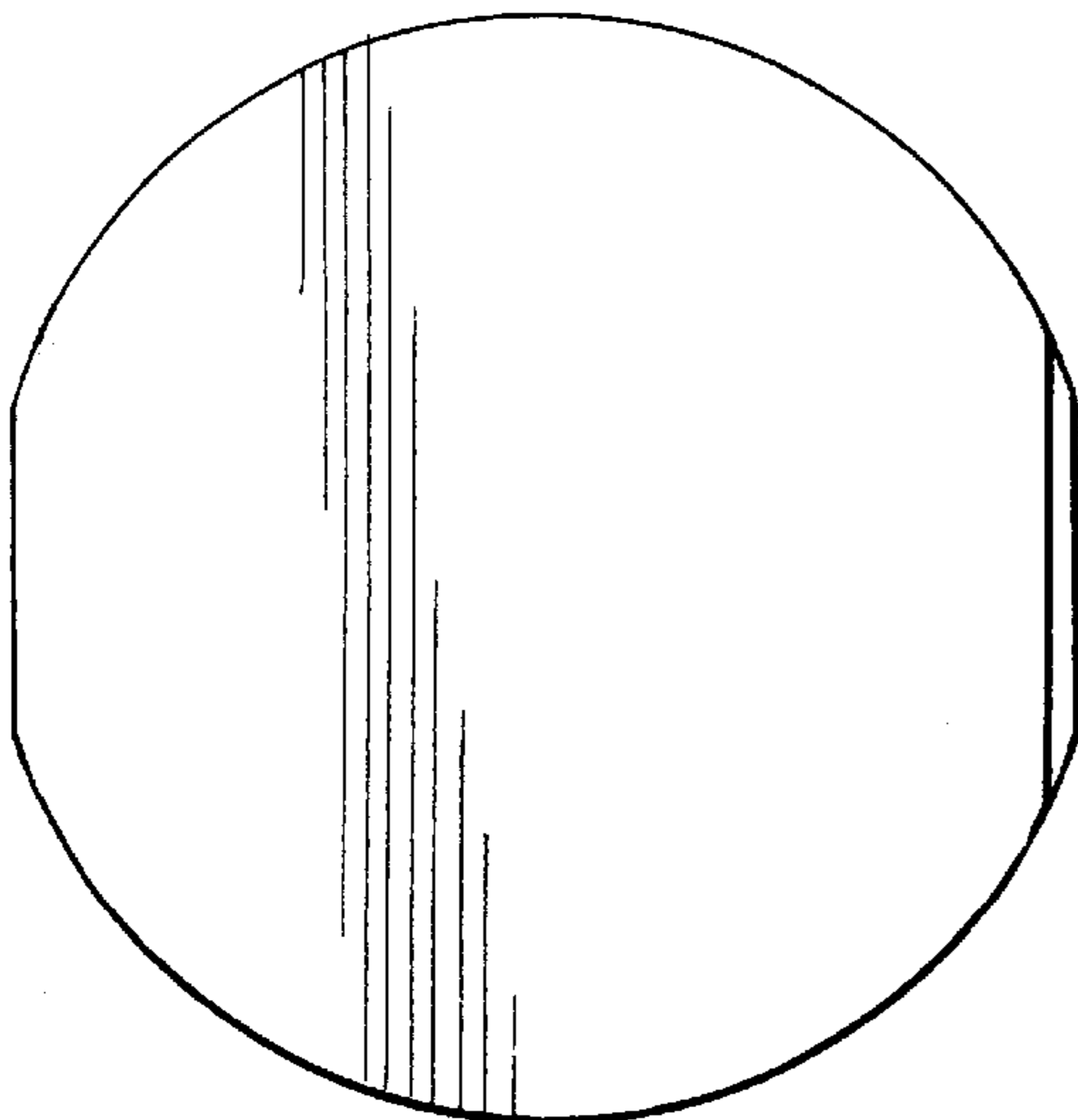

FIG.7

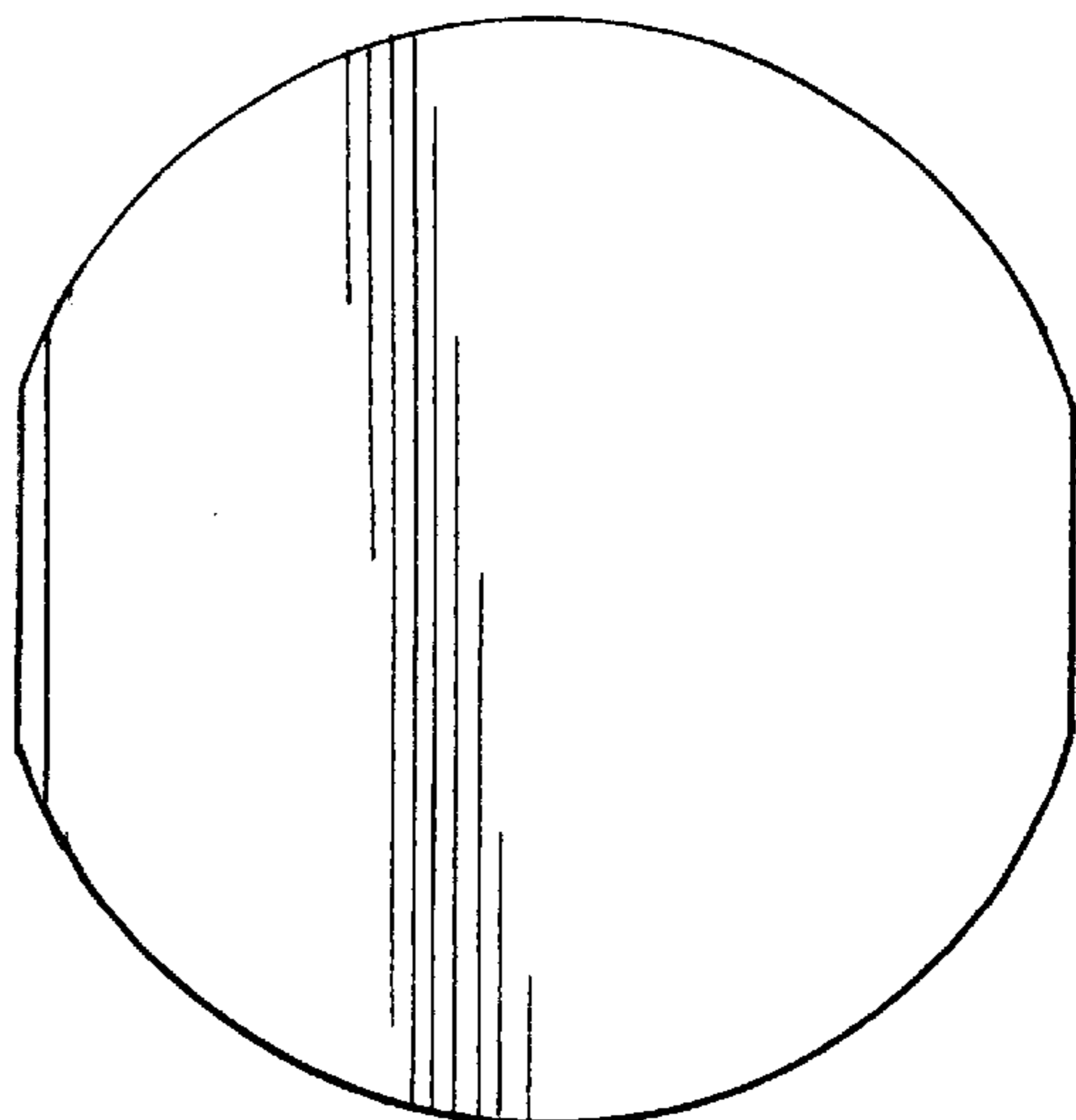

FIG. 8

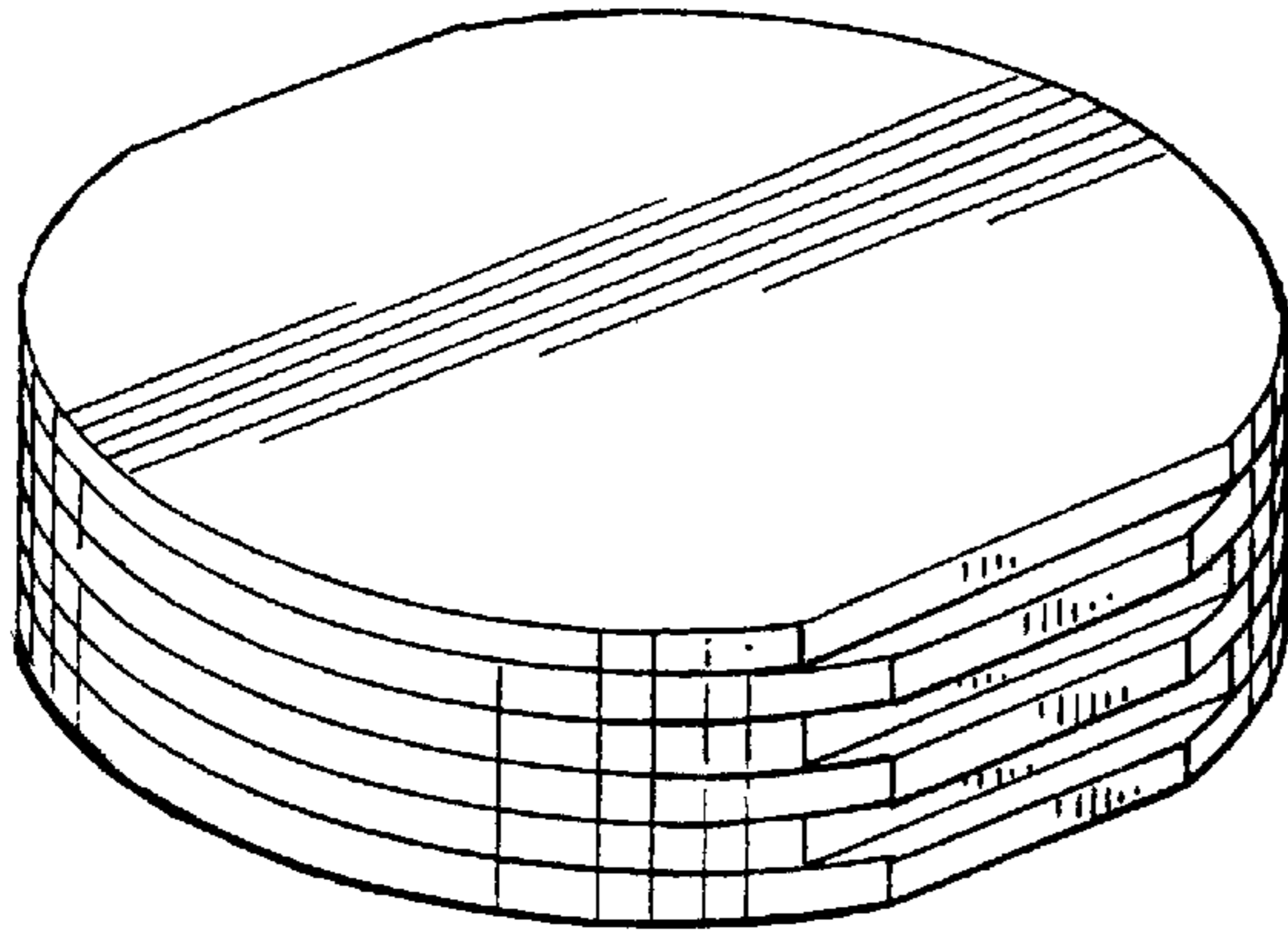

FIG. 9

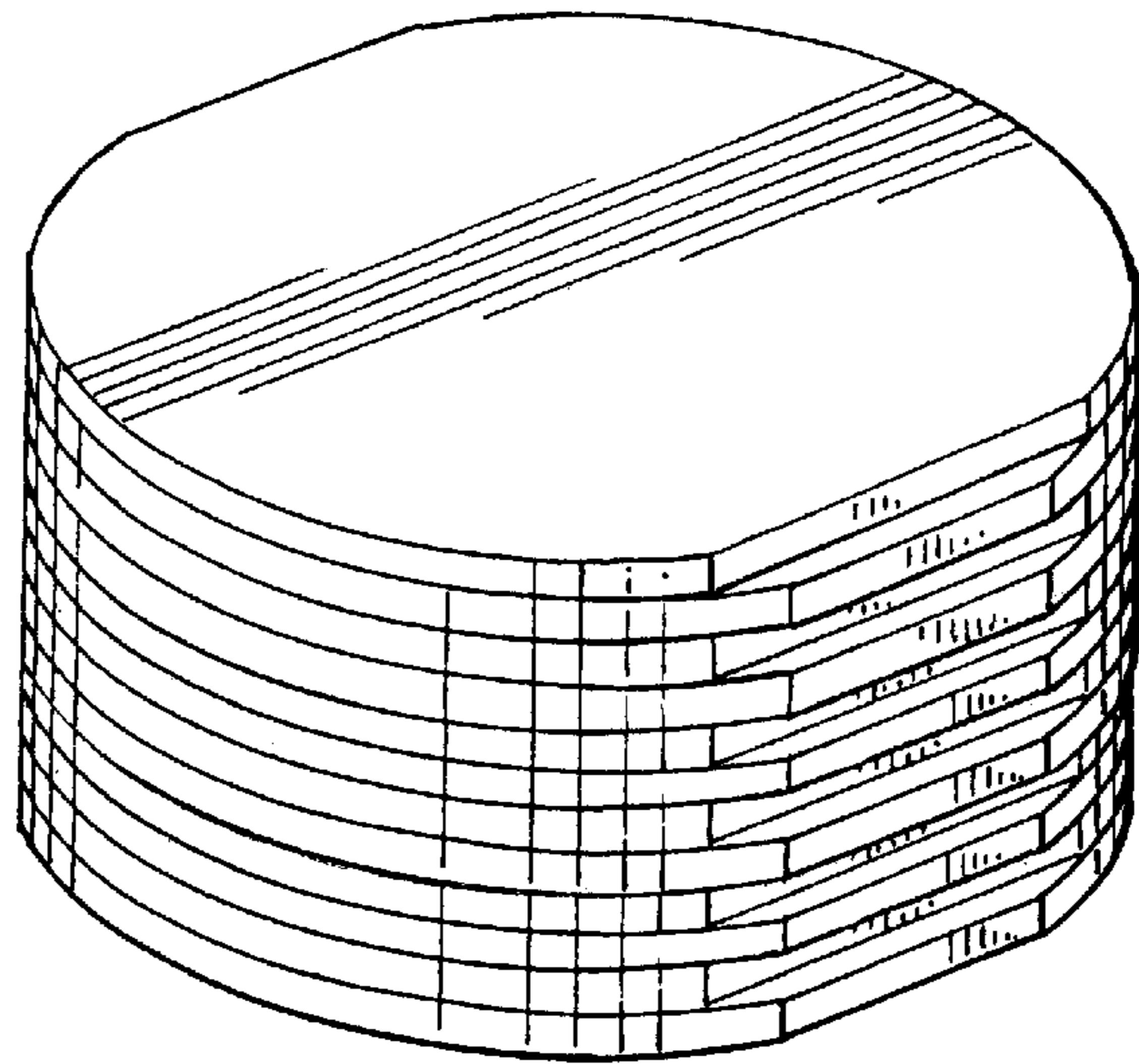

FIG. 10

