



US00D488877S

(12) **United States Design Patent**  
**Shin**

(10) **Patent No.:** **US D488,877 S**

(45) **Date of Patent:** **\*\* Apr. 20, 2004**

(54) **FLASHLIGHT**

(75) **Inventor:** **Stephanie Wai Man Shin, Kowloon (HK)**

(73) **Assignee:** **Gold Coral International Limited, Kowloon (HK)**

(\*\*) **Term:** **14 Years**

(21) **Appl. No.:** **29/181,339**

(22) **Filed:** **May 8, 2003**

(30) **Foreign Application Priority Data**

Nov. 8, 2002 (HK) ..... 02118343

(51) **LOC (7) Cl.** ..... **26-02**

(52) **U.S. Cl.** ..... **D26/49**

(58) **Field of Search** ..... D26/37-50; 362/157,  
362/158, 171, 172, 173, 183-208

(56) **References Cited**

**U.S. PATENT DOCUMENTS**

D366,338 S	*	1/1996	Garrity	.....	D26/49
D410,761 S	*	6/1999	Chiu	.....	D26/49
D425,231 S	*	5/2000	Lynch et al.	.....	D26/49
D442,308 S	*	5/2001	Chiu	.....	D26/49
D443,709 S	*	6/2001	Chiu	.....	D26/49
D479,354 S	*	9/2003	Sharrah et al.	.....	D26/49

\* cited by examiner

*Primary Examiner*—Marcus A. Jackson

(74) *Attorney, Agent, or Firm*—Mitchell Silberberg & Knupp LLP

(57) **CLAIM**

The ornamental design for a flashlight, as shown and described.

**DESCRIPTION**

FIG. 1 is a top plan view of a flashlight according to a first embodiment of the invention.

FIG. 2 is a right side elevational view of the flashlight according to the first embodiment of the invention.

FIG. 3 is a left side elevational view of the flashlight according to the first embodiment of the invention.

FIG. 4 is a bottom plan view of the flashlight according to the first embodiment of the invention.

FIG. 5 is a front elevational view of the flashlight according to the first and second embodiments of the invention.

FIG. 6 is a rear elevational view of the flashlight according to the first and second embodiments of the invention.

FIG. 7 is a top plan view of a flashlight according to a second embodiment of the invention.

FIG. 8 is a right side elevational view of the flashlight according to the second embodiment of the invention.

FIG. 9 is a left side elevational view of the flashlight according to the second embodiment of the invention.

FIG. 10 is a bottom plan view of the flashlight according to the second embodiment of the invention.

FIG. 11 is a top plan view of a flashlight according to a third embodiment of the invention.

FIG. 12 is a right side elevational view of the flashlight according to the third embodiment of the invention.

FIG. 13 is a left side elevational view of the flashlight according to the third embodiment of the invention.

FIG. 14 is a bottom plan view of the flashlight according to the third embodiment of the invention.

FIG. 15 is a front elevational view of the flashlight according to the third and fourth embodiments of the invention.

FIG. 16 is a rear elevational view of the flashlight according to the third and fourth embodiments of the invention.

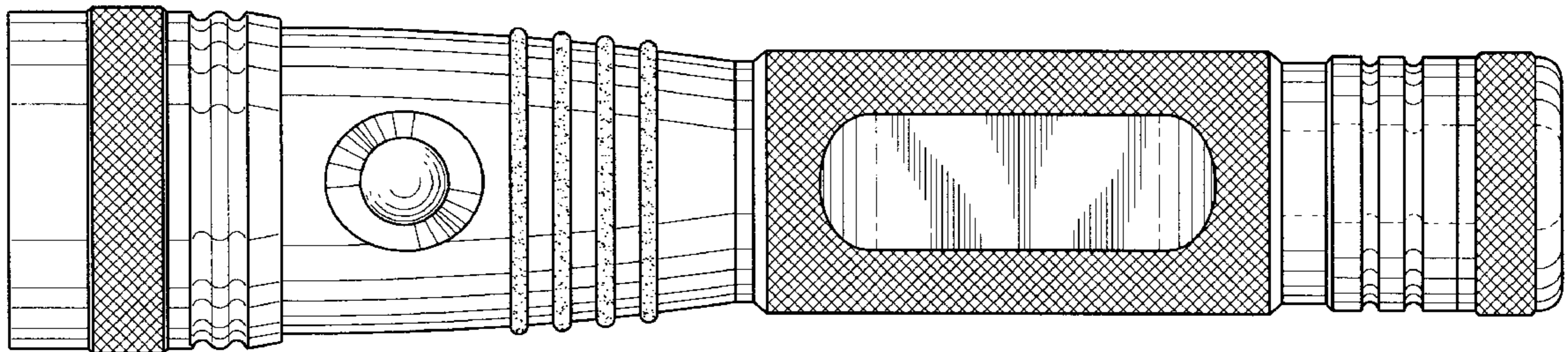
FIG. 17 is a top plan view of a flashlight according to a fourth embodiment of the invention.

FIG. 18 is a right side elevational view of the flashlight according to the fourth embodiment of the invention.

FIG. 19 is a left side elevational view of the flashlight according to the fourth embodiment of the invention; and,

FIG. 20 is a bottom plan view of the flashlight according to the fourth embodiment of the invention.

**1 Claim, 10 Drawing Sheets**



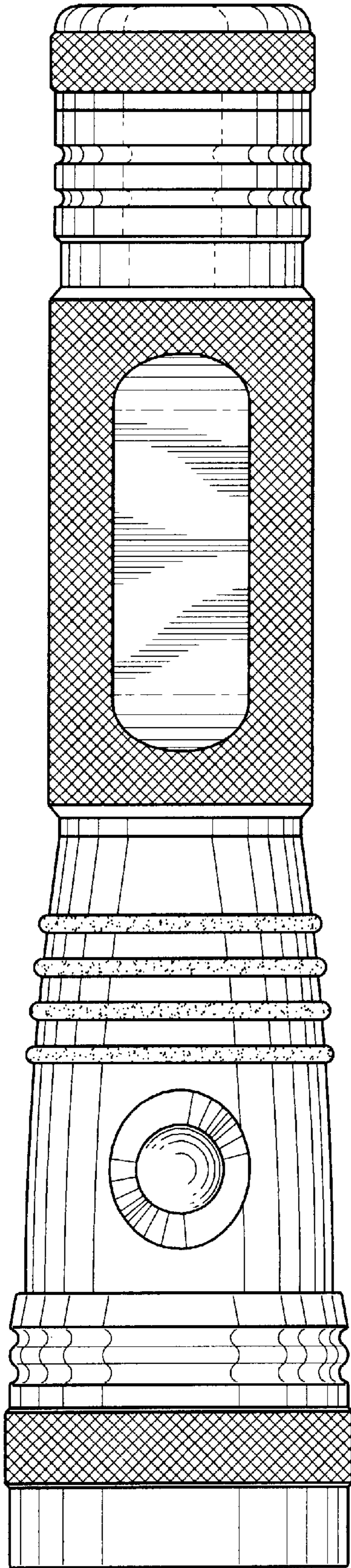


FIG. 1

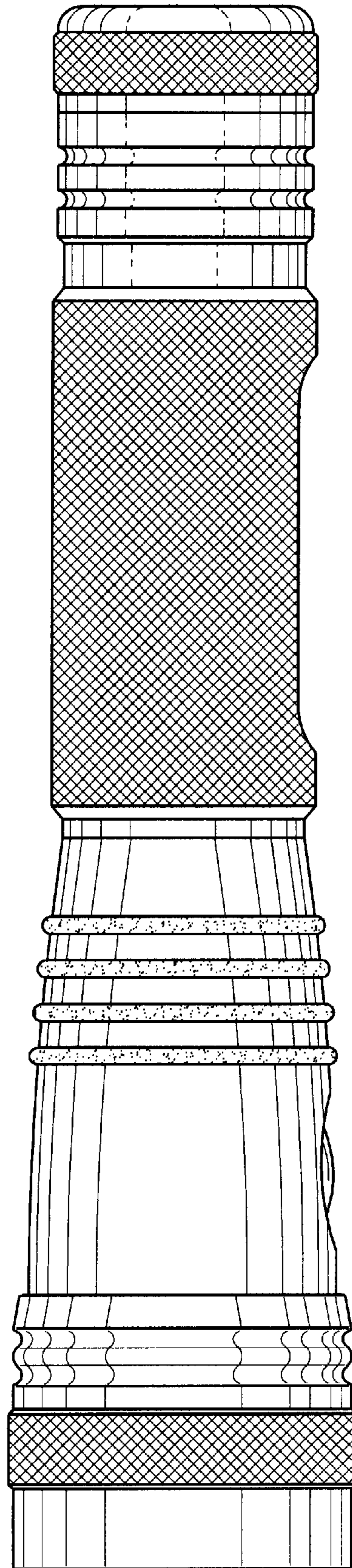


FIG. 2

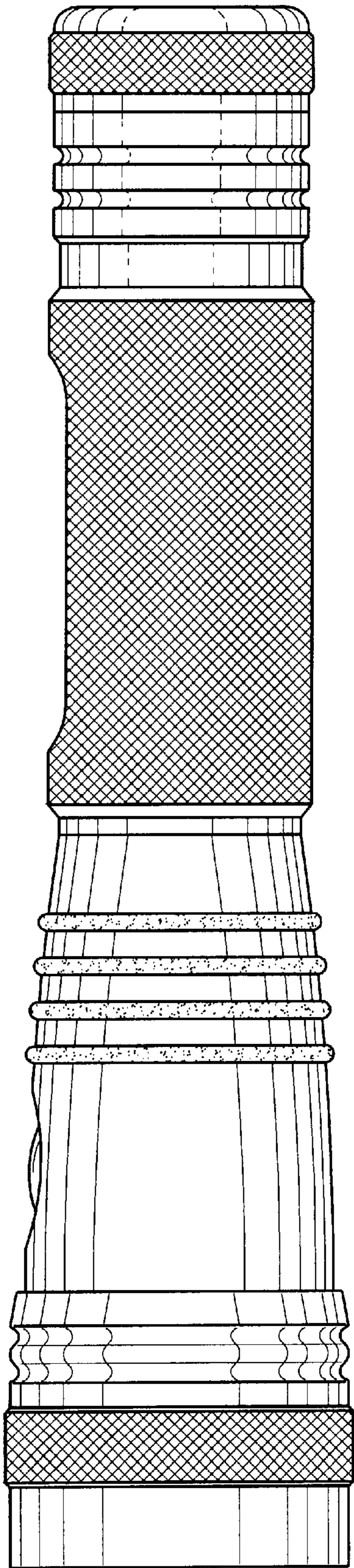


FIG. 3

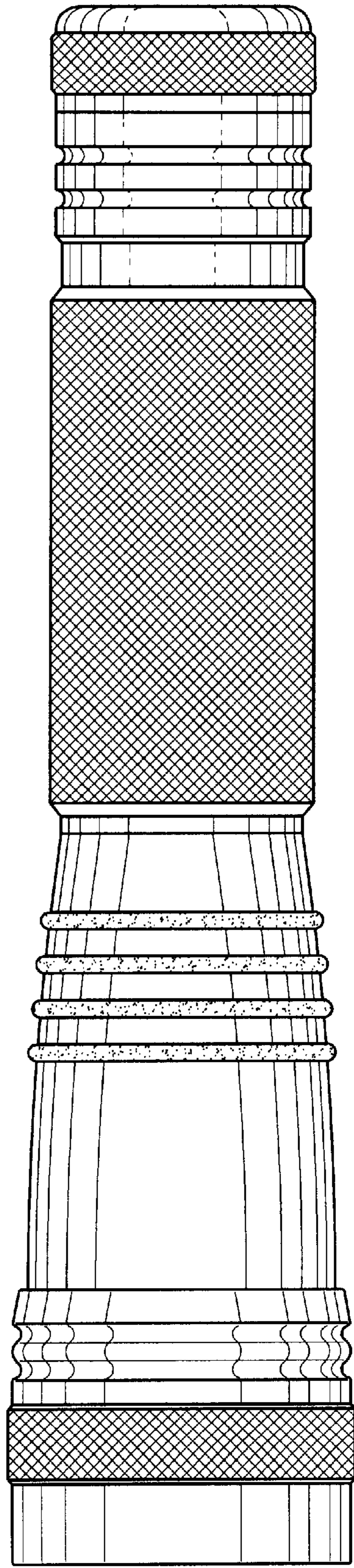


FIG. 4

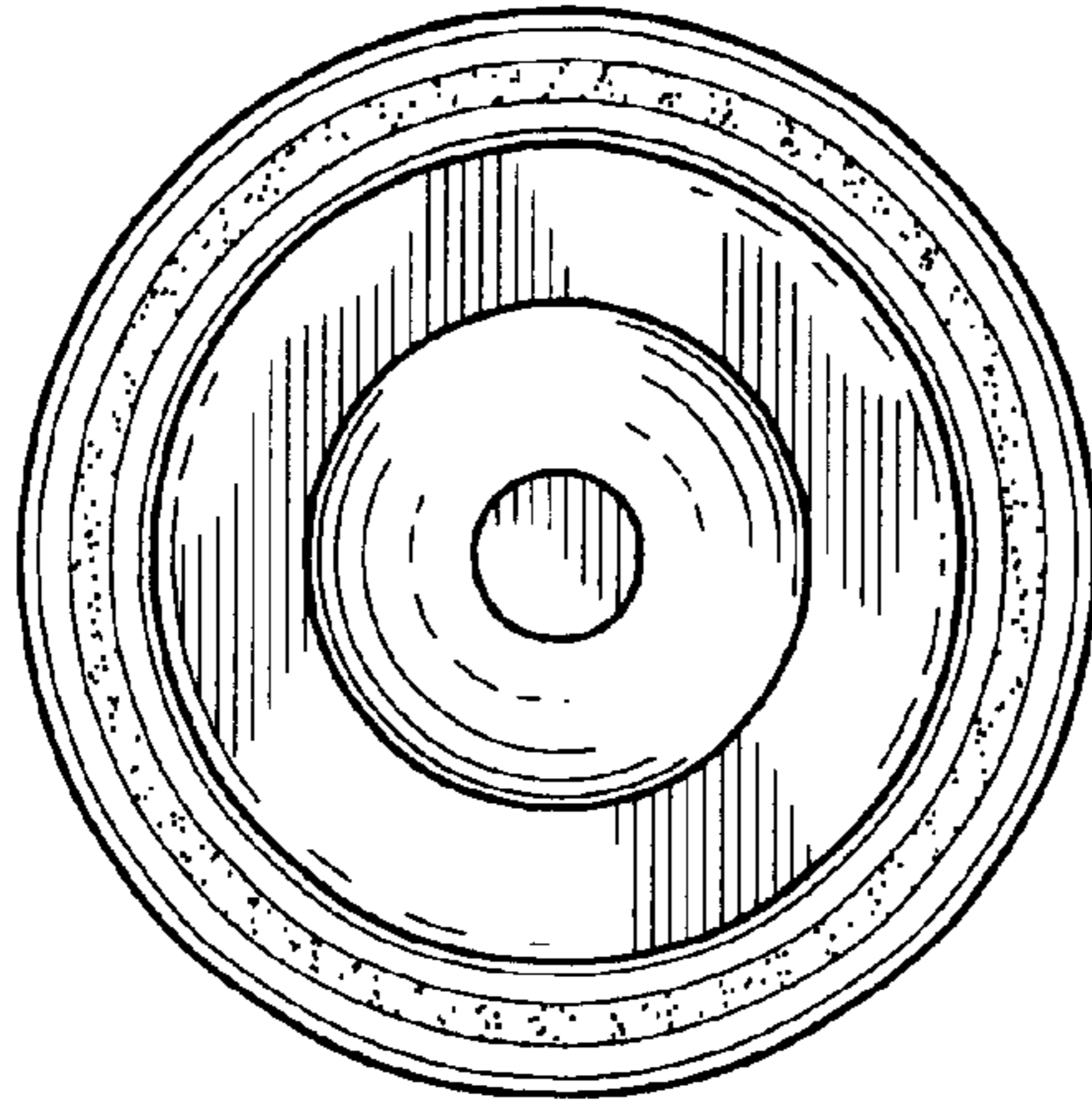


FIG. 6

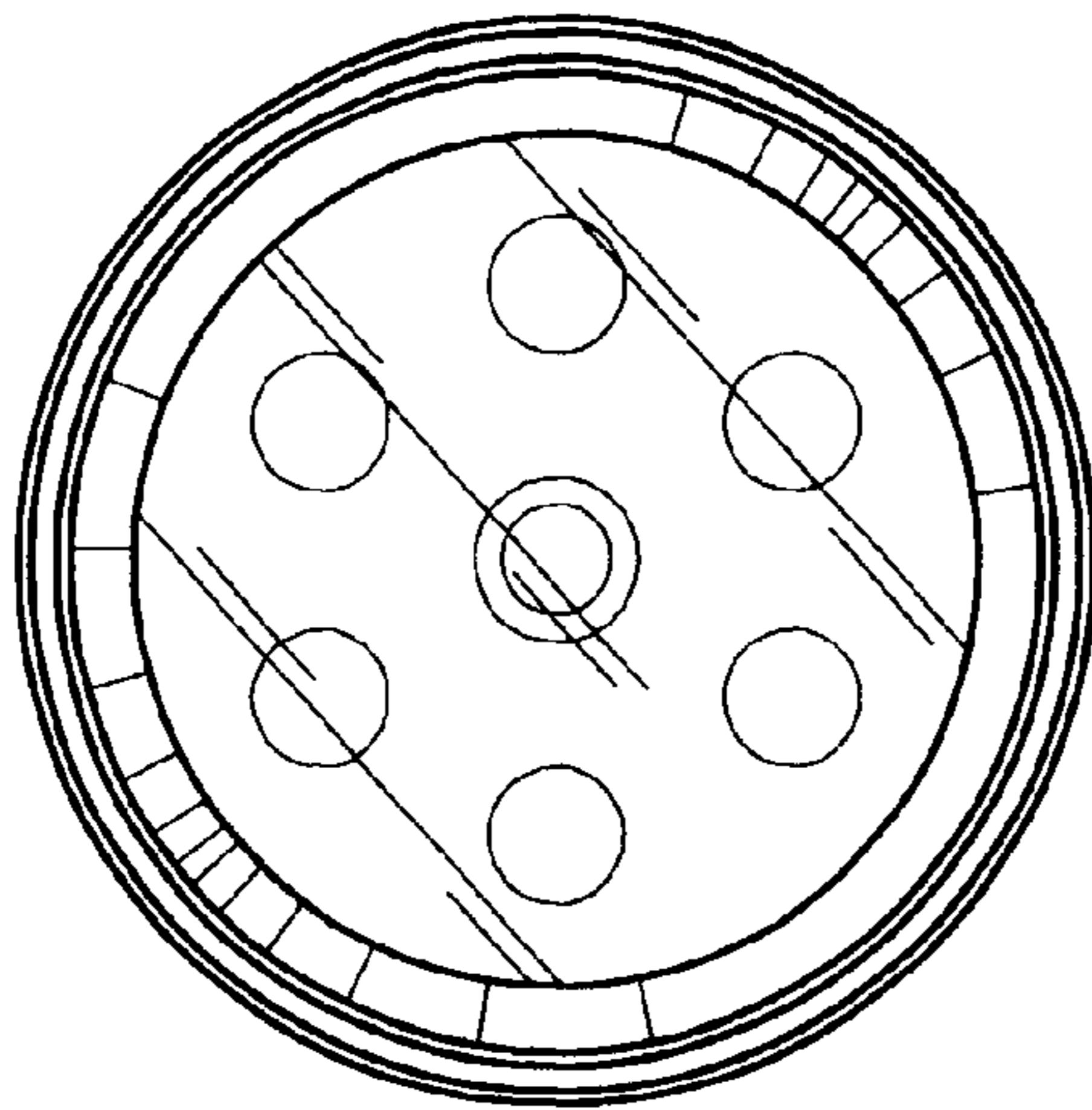


FIG. 5

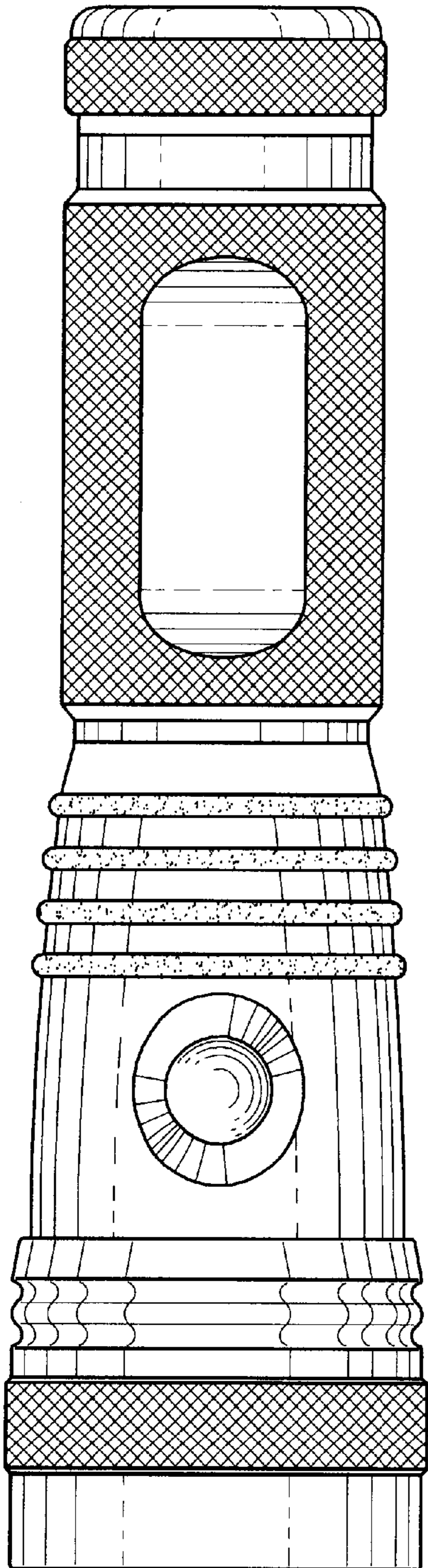


FIG. 7

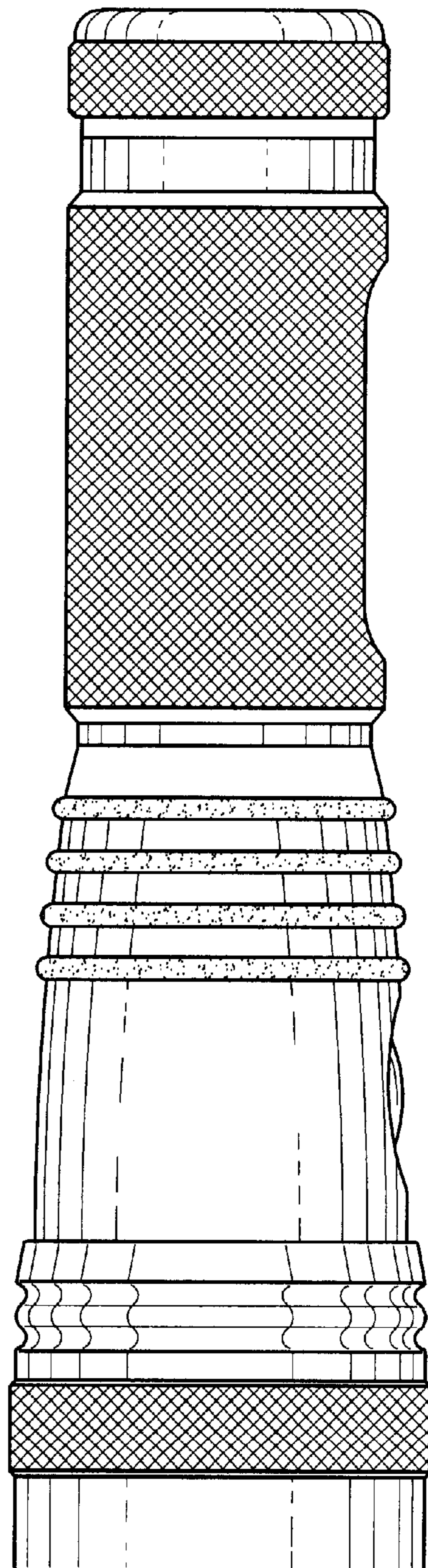


FIG. 8

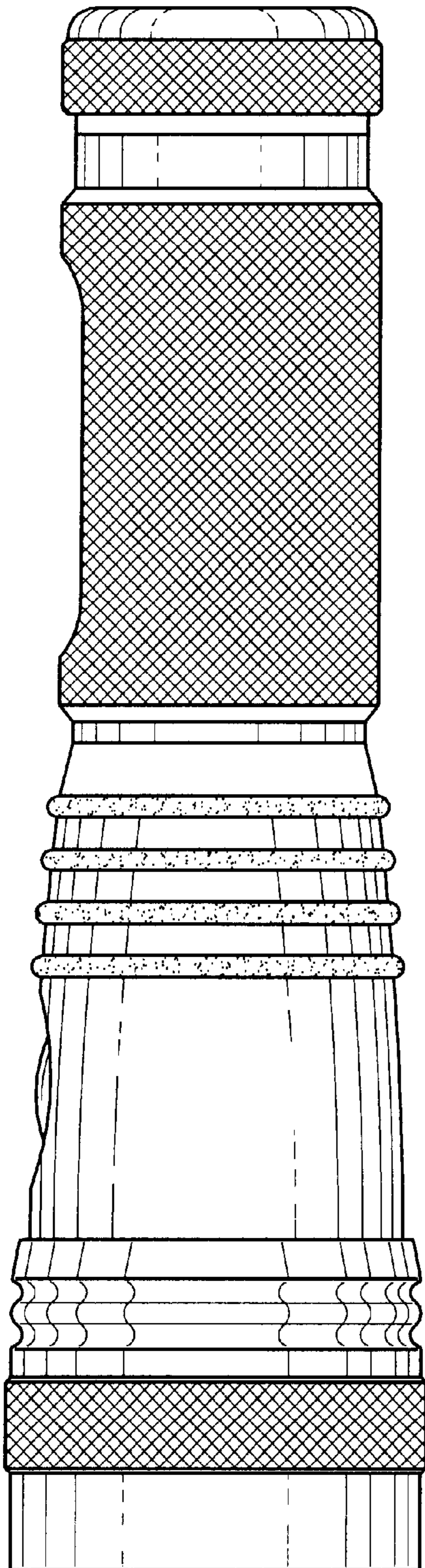


FIG. 9

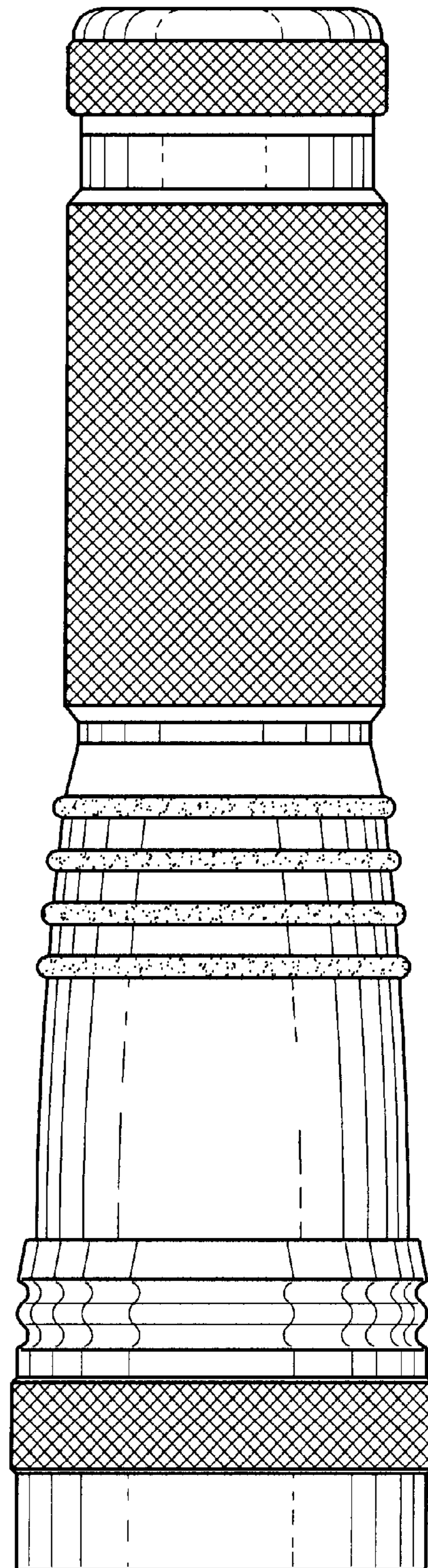
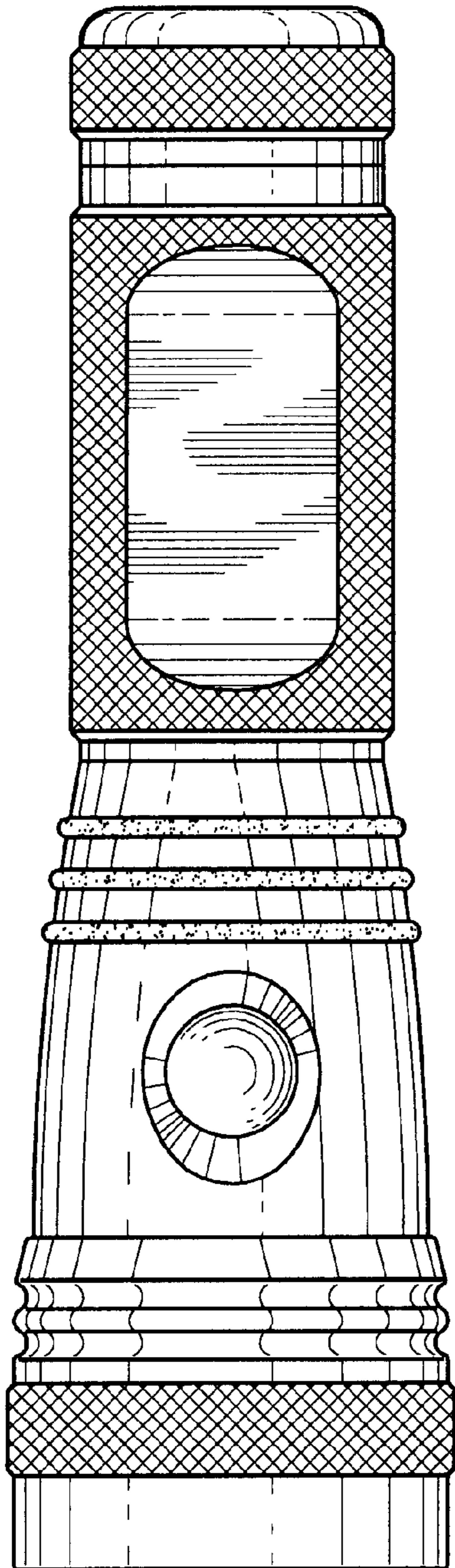
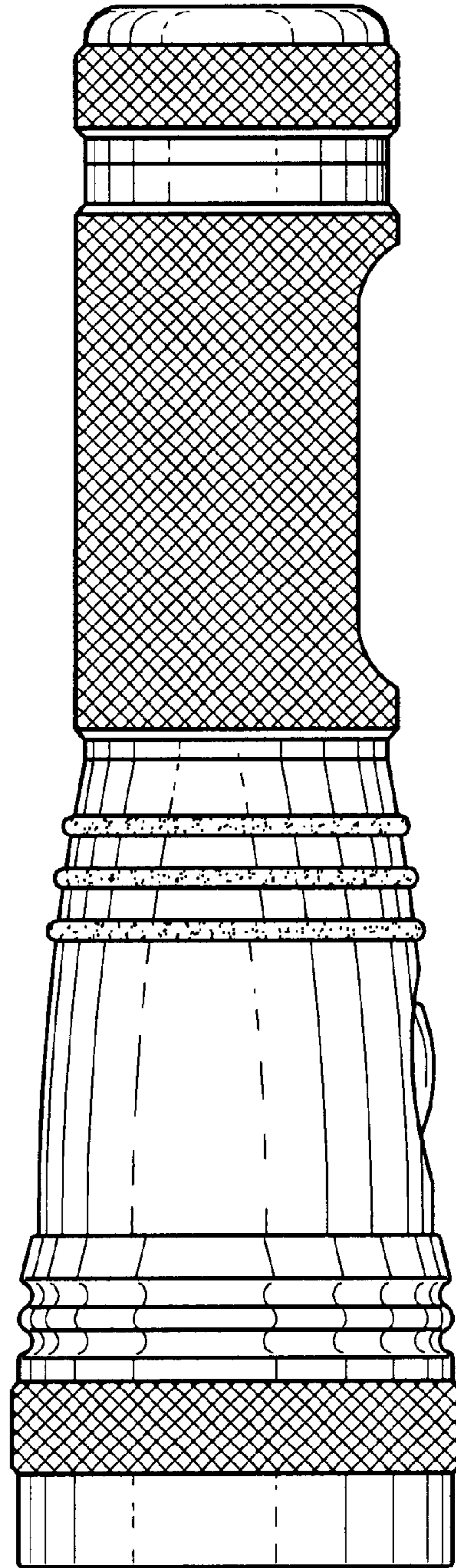


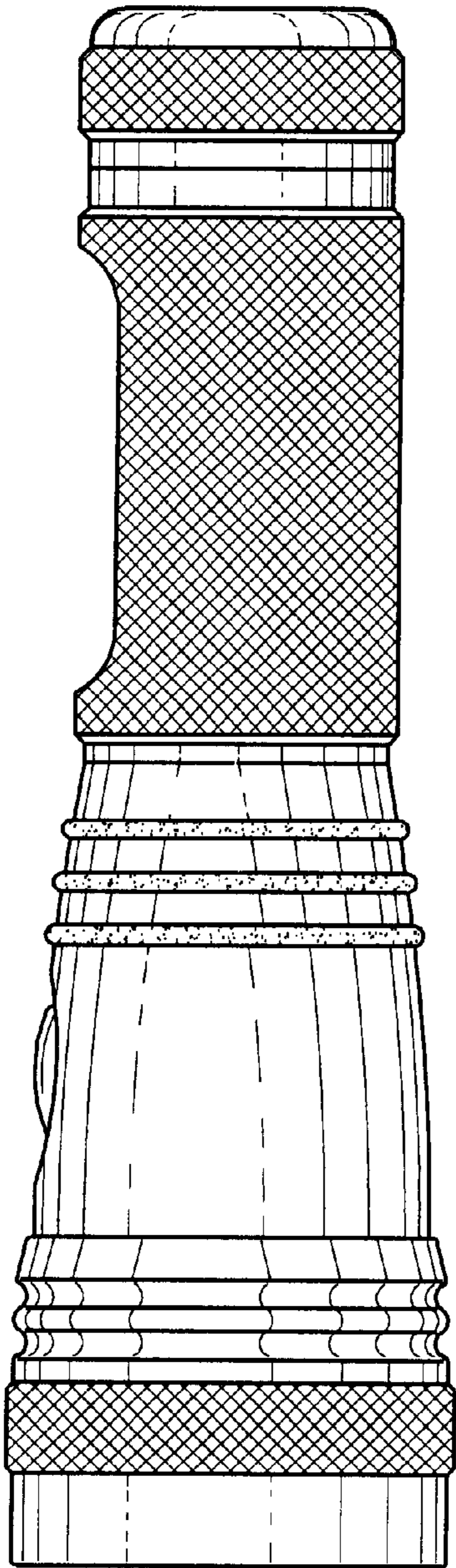
FIG. 10



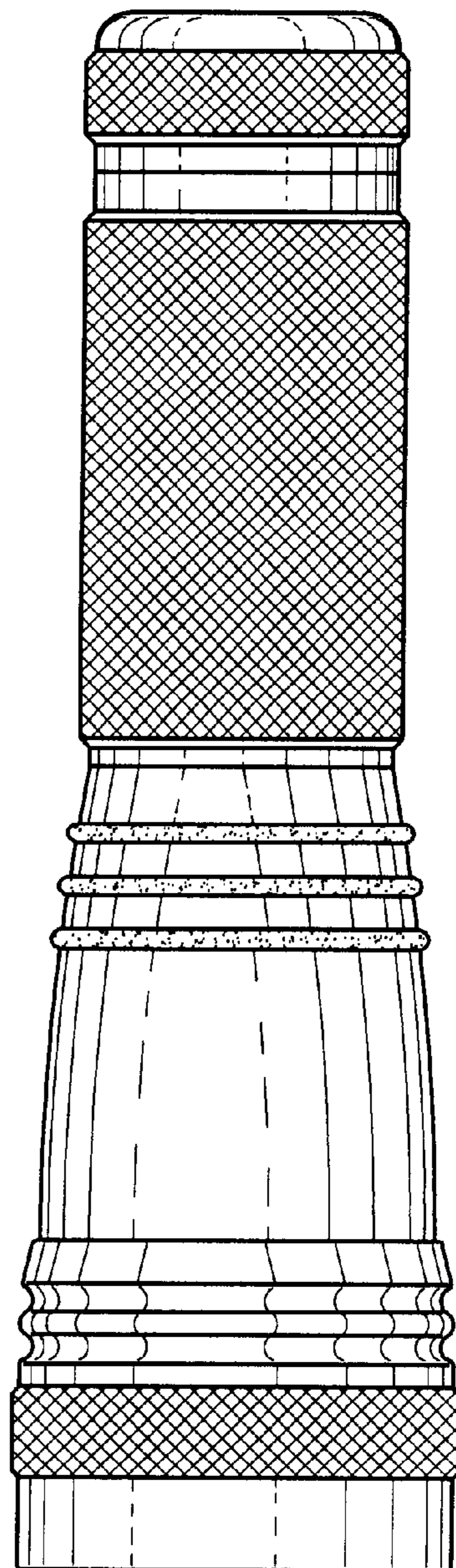
*FIG. 11*



*FIG. 12*

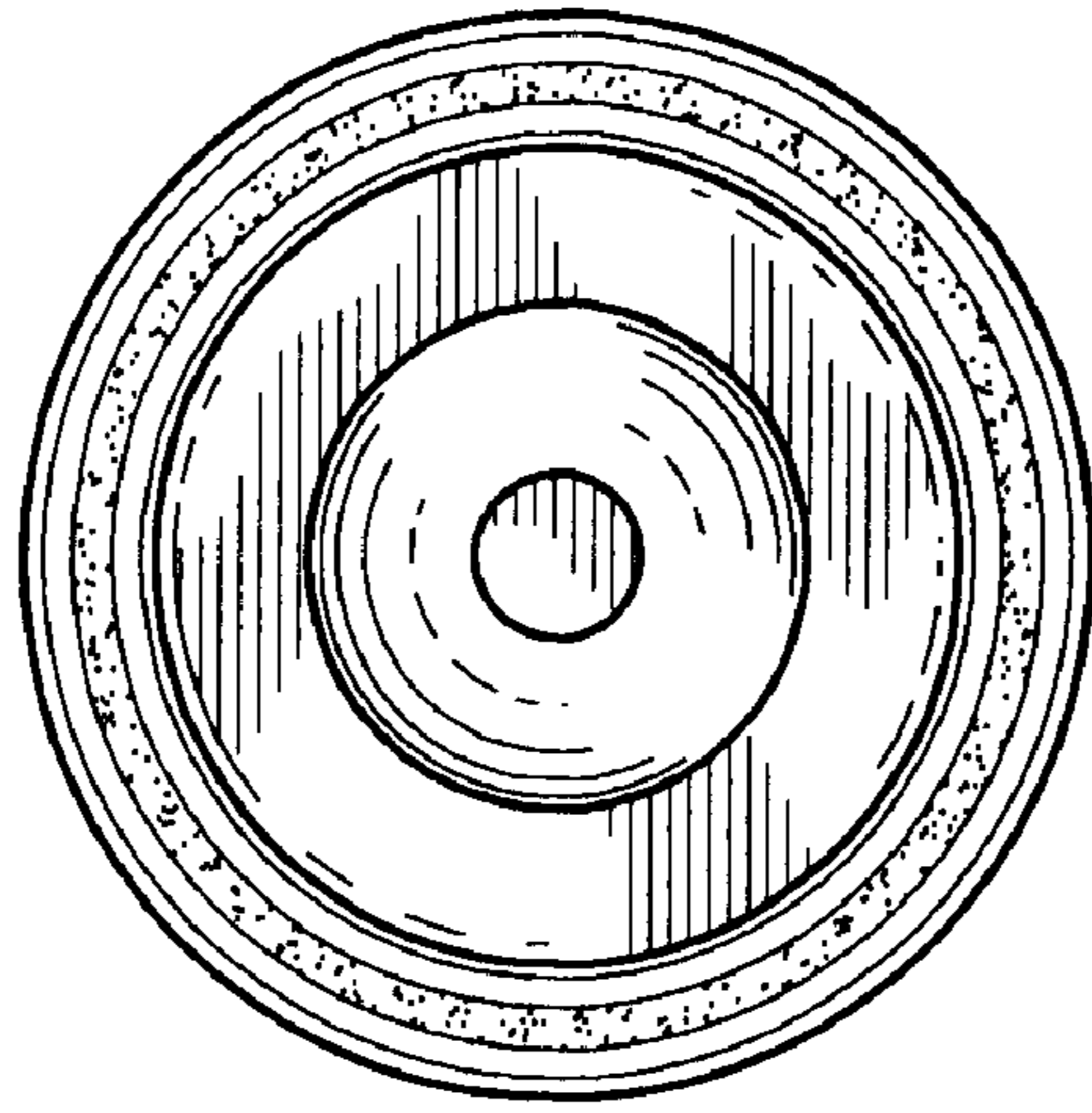


*FIG. 13*

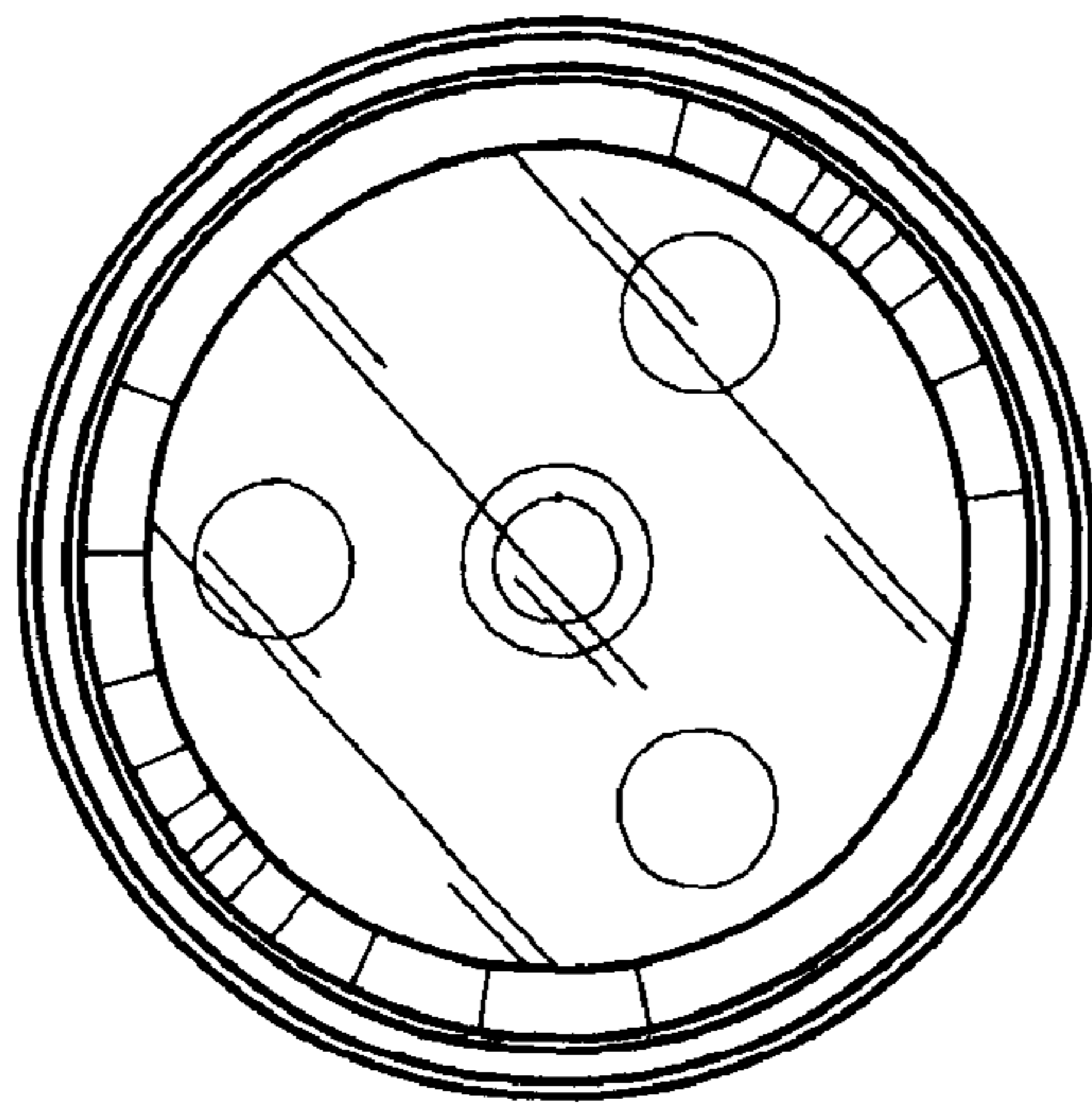


*FIG. 14*

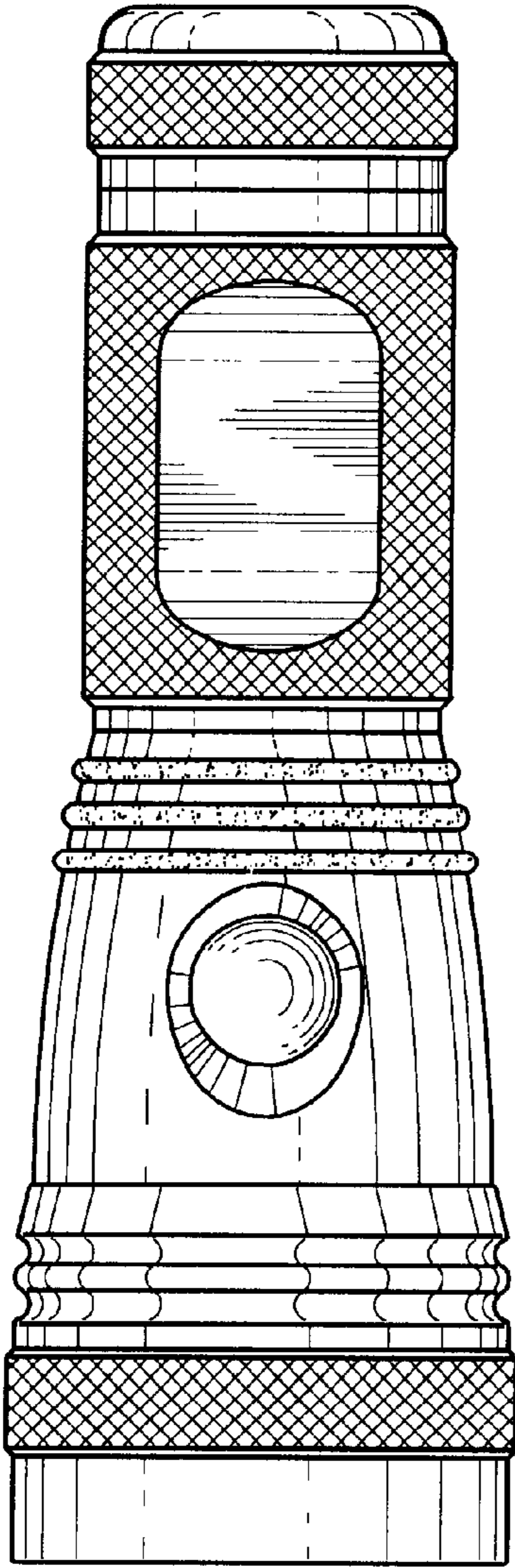




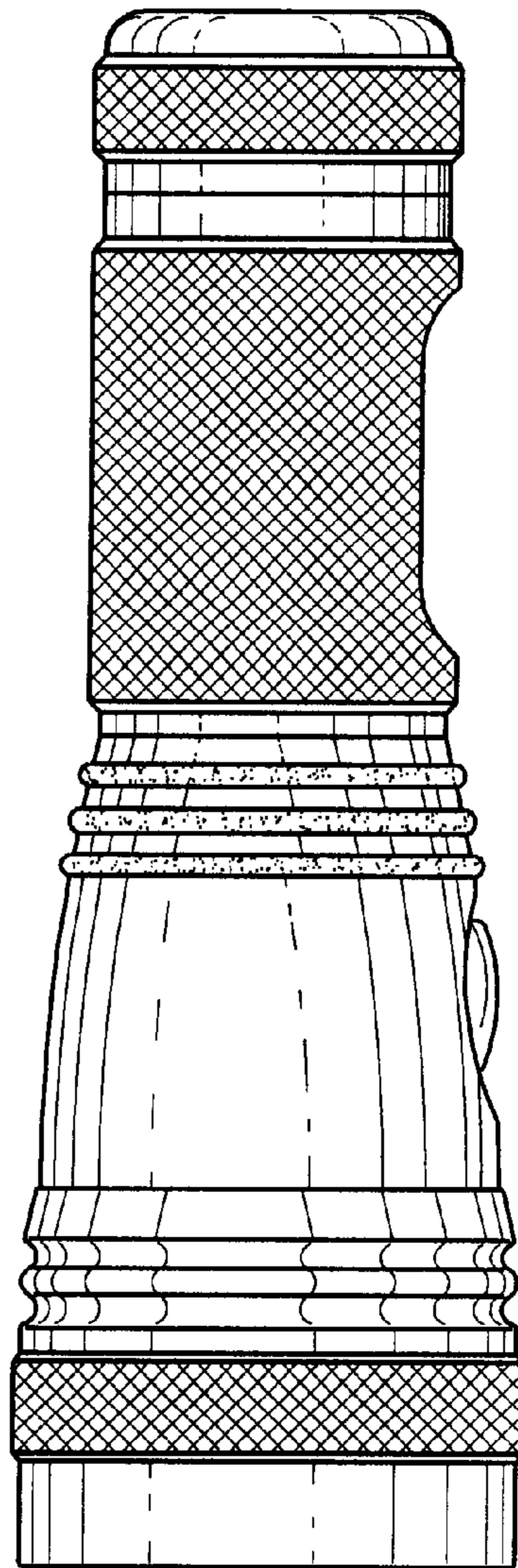
*FIG. 16*



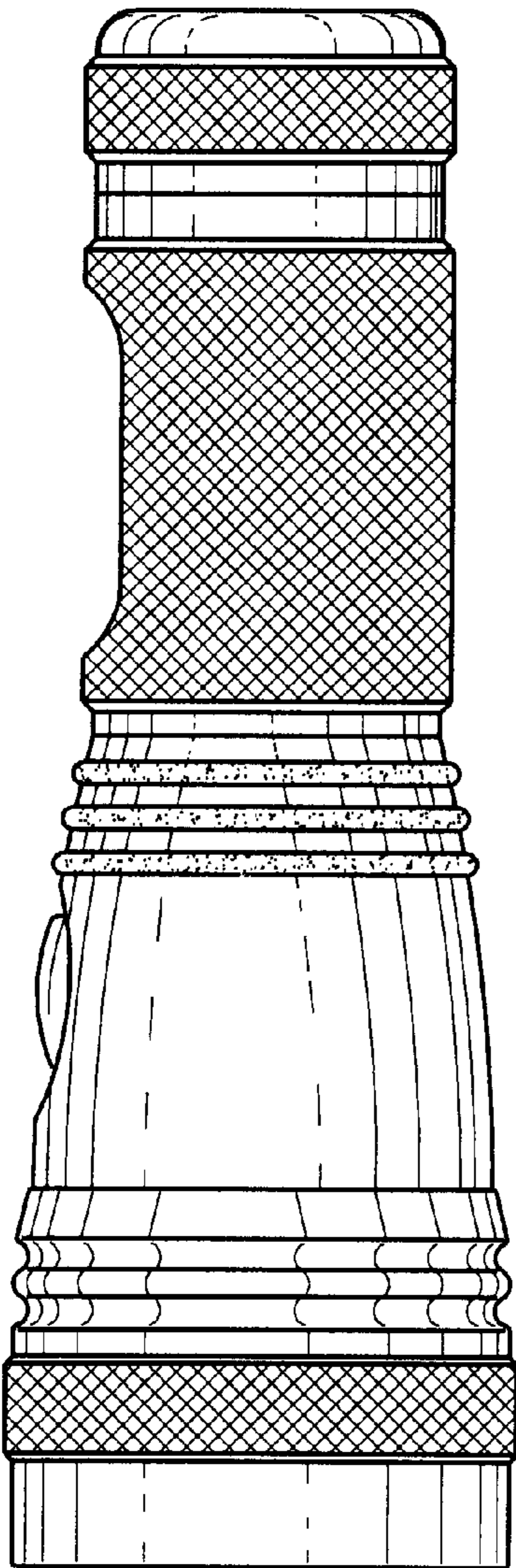
*FIG. 15*



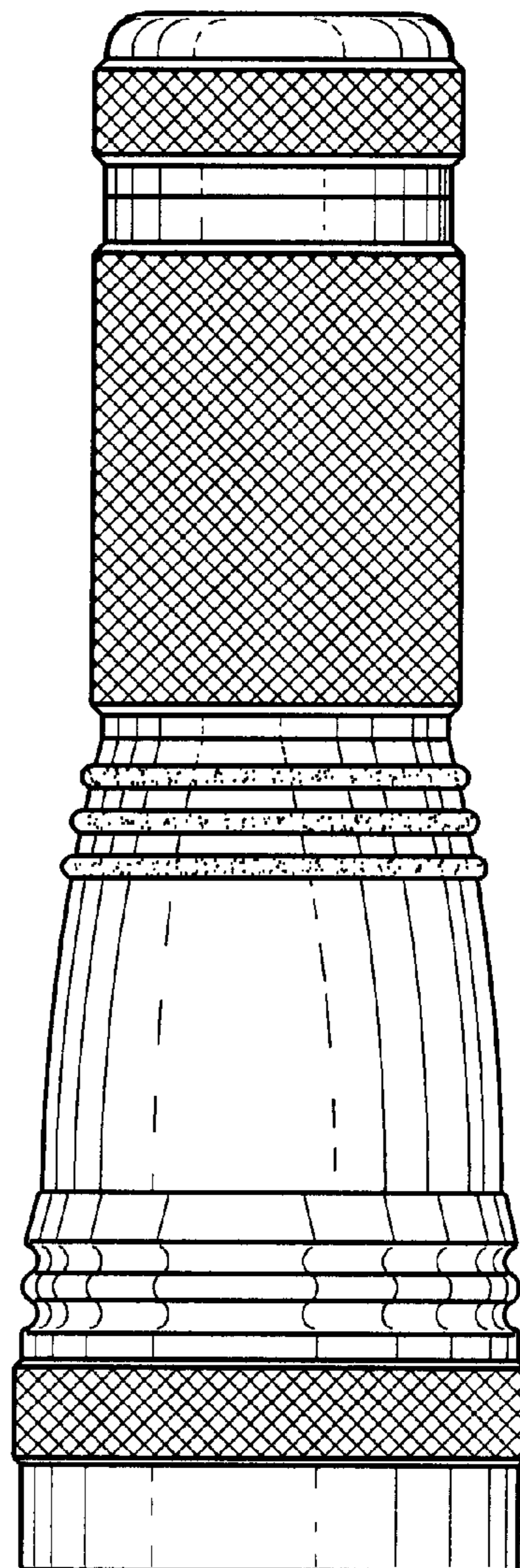
*FIG. 17*



*FIG. 18*



*FIG. 19*



*FIG. 20*

UNITED STATES PATENT AND TRADEMARK OFFICE  
**CERTIFICATE OF CORRECTION**

PATENT NO. : Des. 488,877 S  
DATED : April 20, 2004  
INVENTOR(S) : Stephanie Wai Man Shiu

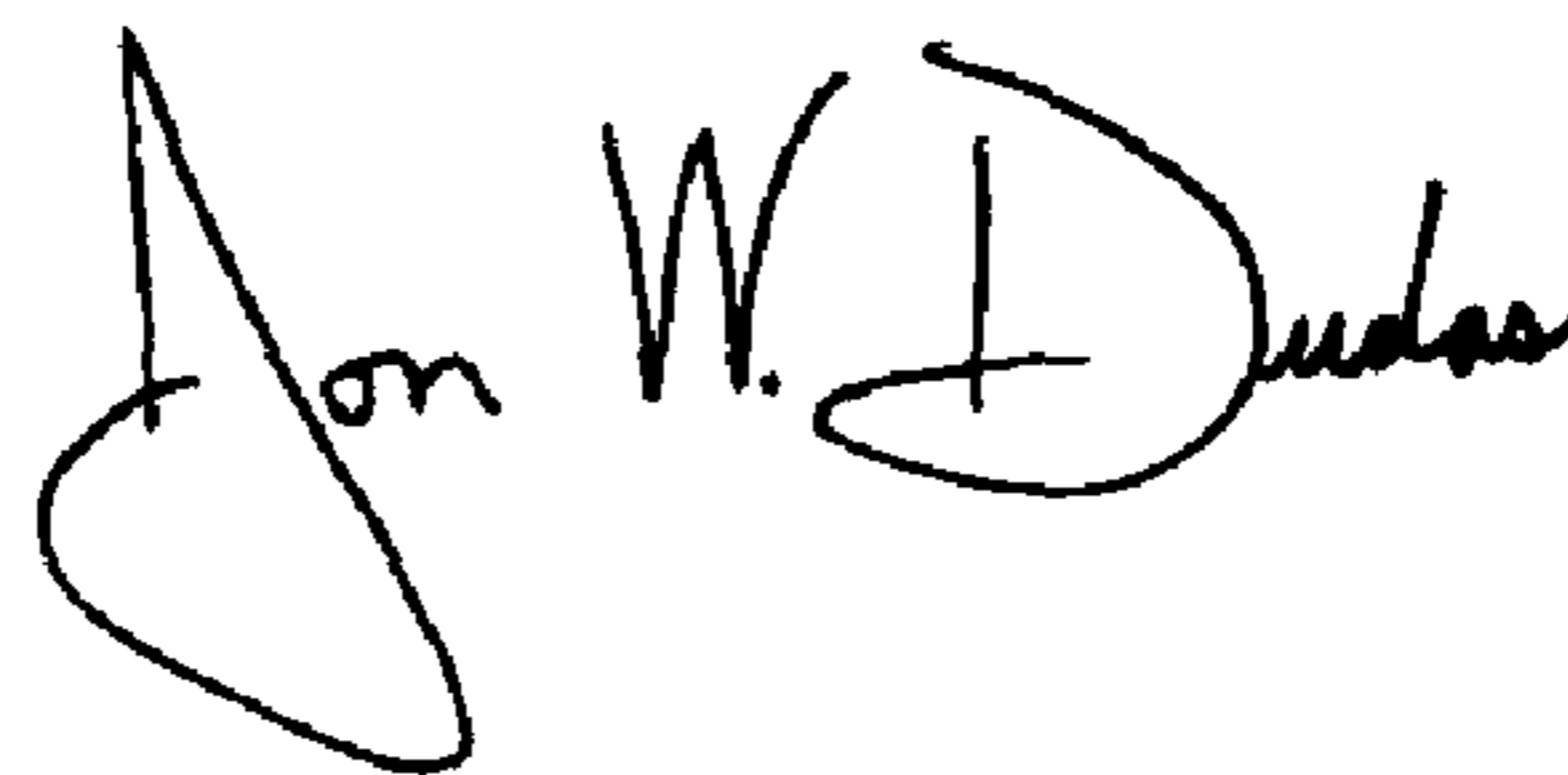
Page 1 of 1

It is certified that error appears in the above-identified patent and that said Letters Patent is hereby corrected as shown below:

Title page,  
Item [75], Inventor, change "**Shin**" to -- **Shiu** --

Signed and Sealed this

Twenty-seventh Day of July, 2004

A handwritten signature in black ink that reads "Jon W. Dudas". The signature is written in a cursive style with a large, looped initial "J".

---

JON W. DUDAS  
*Acting Director of the United States Patent and Trademark Office*