



US00D488812S

(12) **United States Design Patent**
Chiu

(10) **Patent No.:** **US D488,812 S**

(45) **Date of Patent:** **** Apr. 20, 2004**

- (54) **LIQUID CRYSTAL DISPLAY**
- (75) Inventor: **Elther Chiu**, Taipei Hsien (TW)
- (73) Assignee: **Hannspre, Inc.**, Taipei (TW)
- (**) Term: **14 Years**
- (21) Appl. No.: **29/162,115**
- (22) Filed: **Jun. 10, 2002**
- (51) **LOC (7) Cl.** **14-02**
- (52) **U.S. Cl.** **D14/375**
- (58) **Field of Search** D14/371-375,
D14/125-129; 248/917-924; 348/180, 184,
325, 739; 345/104, 156, 168, 173, 901-905;
349/1, 2, 11, 62; 341/12; D26/62, 108;
D16/135

- D381,323 S * 7/1997 Hartman D14/374
- D425,651 S * 5/2000 Gager et al. D26/108
- D455,855 S * 4/2002 Emerson et al. D26/62
- D482,688 S * 11/2003 Jung D14/375

* cited by examiner

Primary Examiner—Freda Nunn

(74) *Attorney, Agent, or Firm*—Thomas, Kayden,
Horstemeyer & Risley

(56) **References Cited**
U.S. PATENT DOCUMENTS

- D225,260 S * 11/1972 Morris D26/62
- D229,231 S * 11/1973 Beeren D16/135

(57) **CLAIM**

The ornamental design for a liquid crystal display, as shown and described.

DESCRIPTION

FIG. 1 is a front perspective view thereof;
FIG. 2 is a right side elevational view thereof;
FIG. 3 is a top plane view thereof;
FIG. 4 is a front elevational view thereof;
FIG. 5 is a bottom plane view thereof;
FIG. 6 is a left side elevational view thereof; and,
FIG. 7 is a rear elevational view thereof.

1 Claim, 7 Drawing Sheets

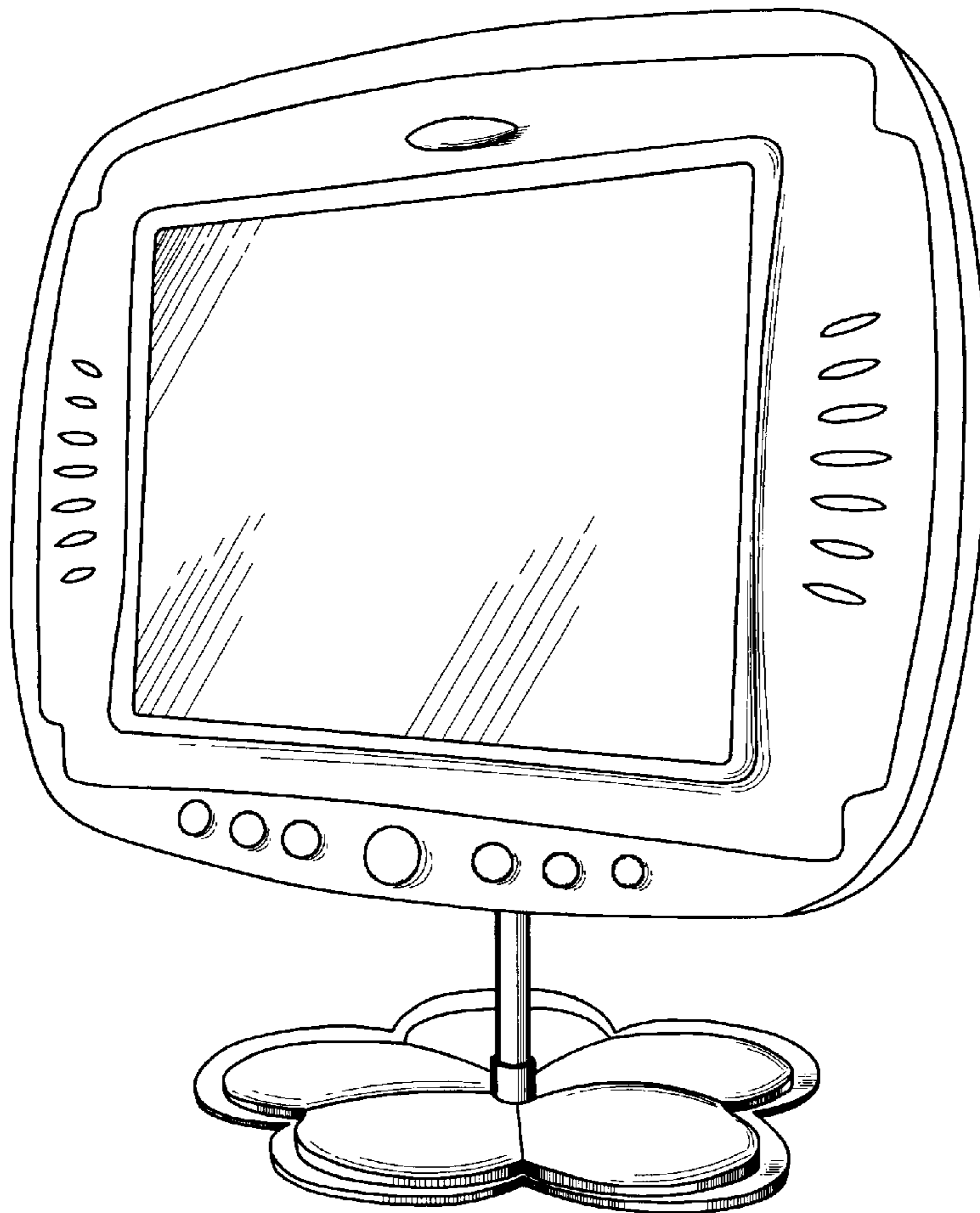

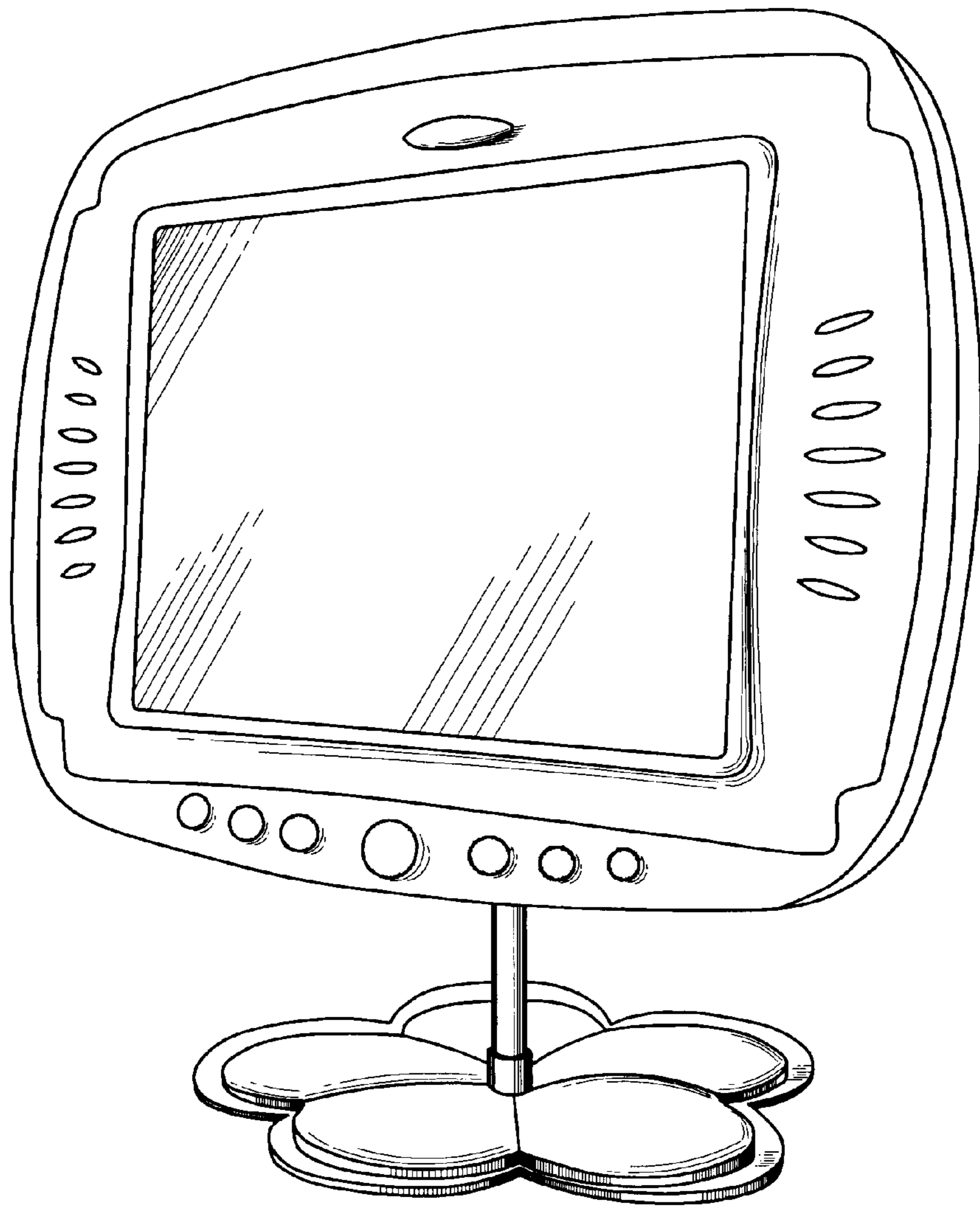

Fig. 1

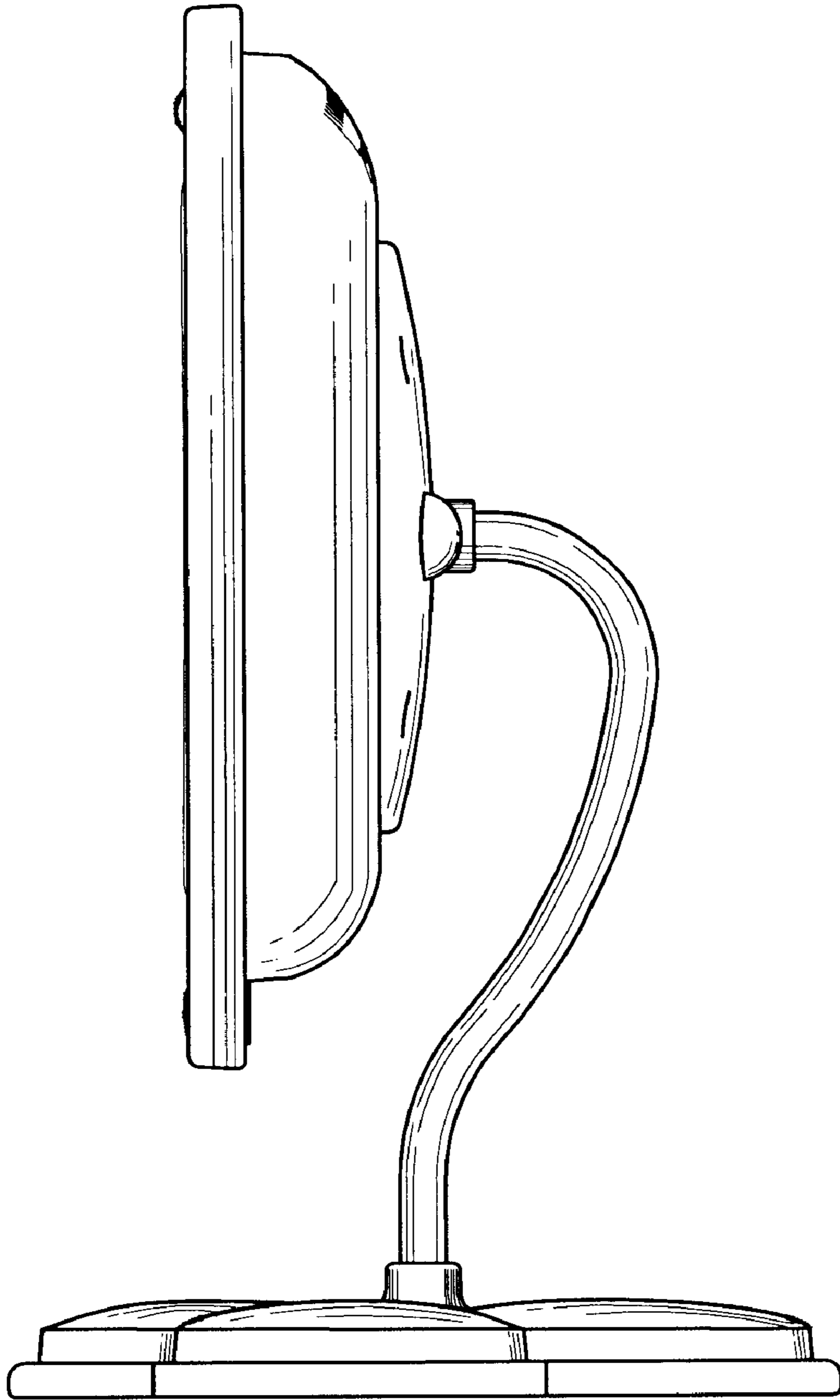

Fig. 2

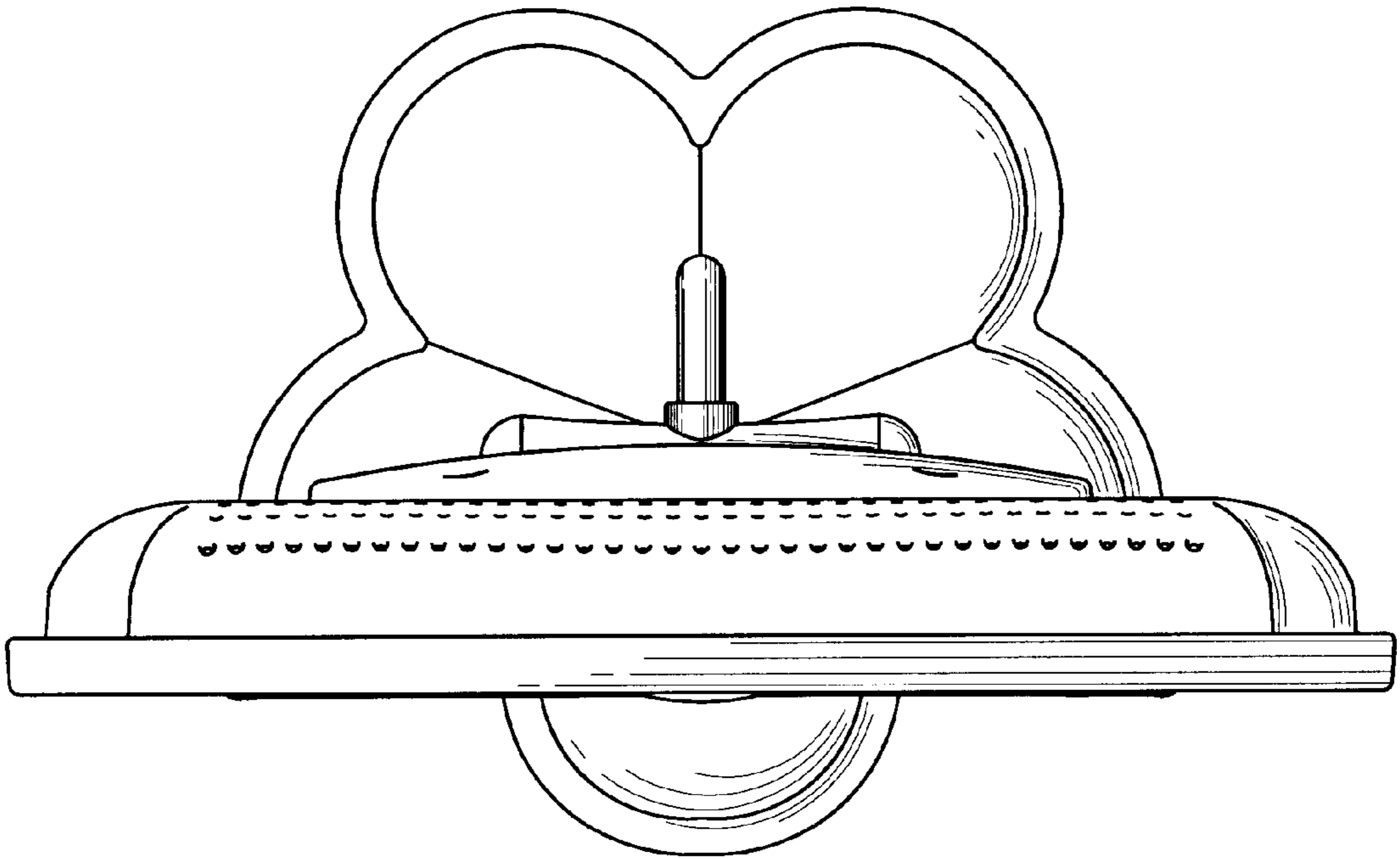

Fig. 3

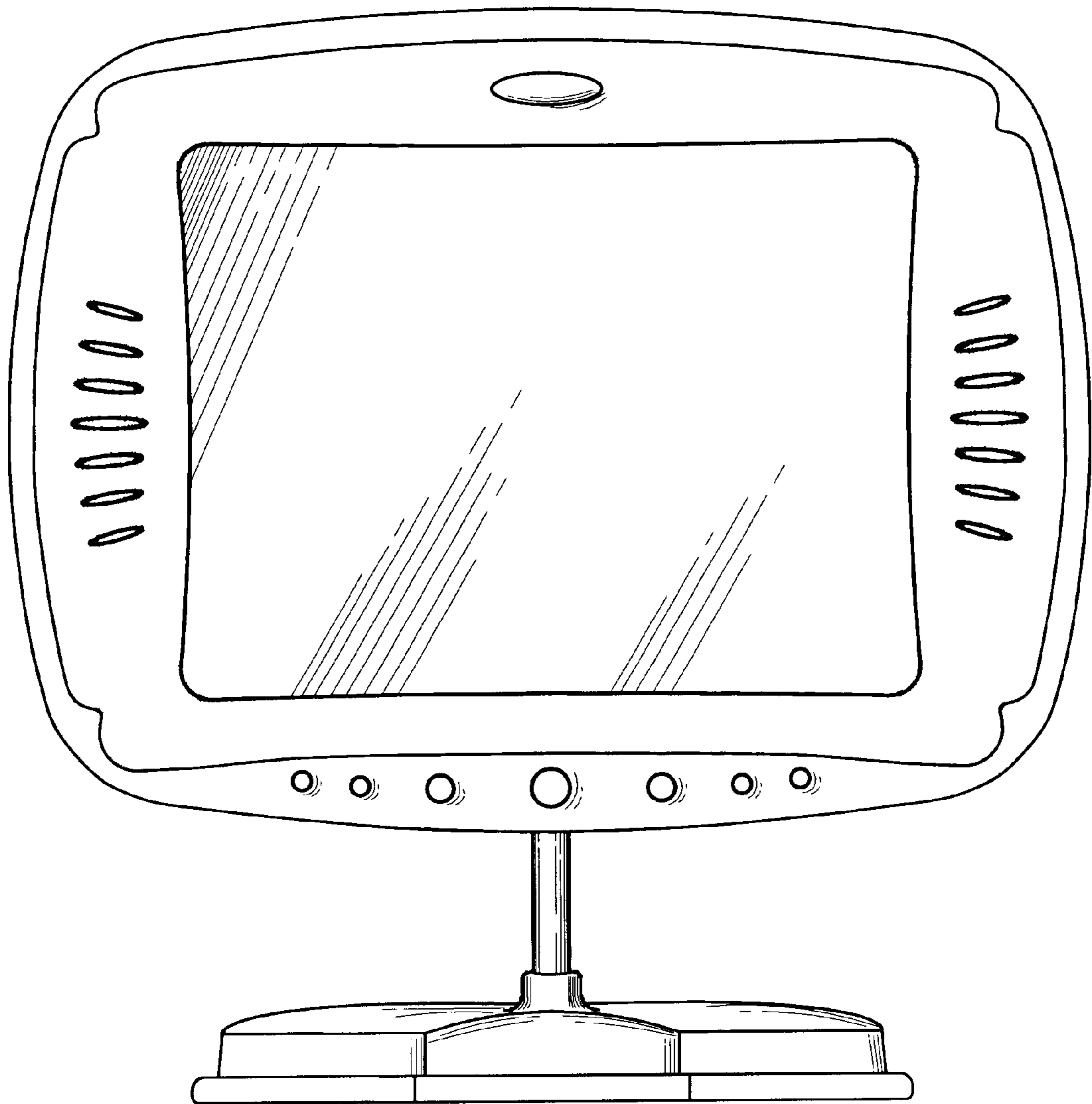

Fig. 4

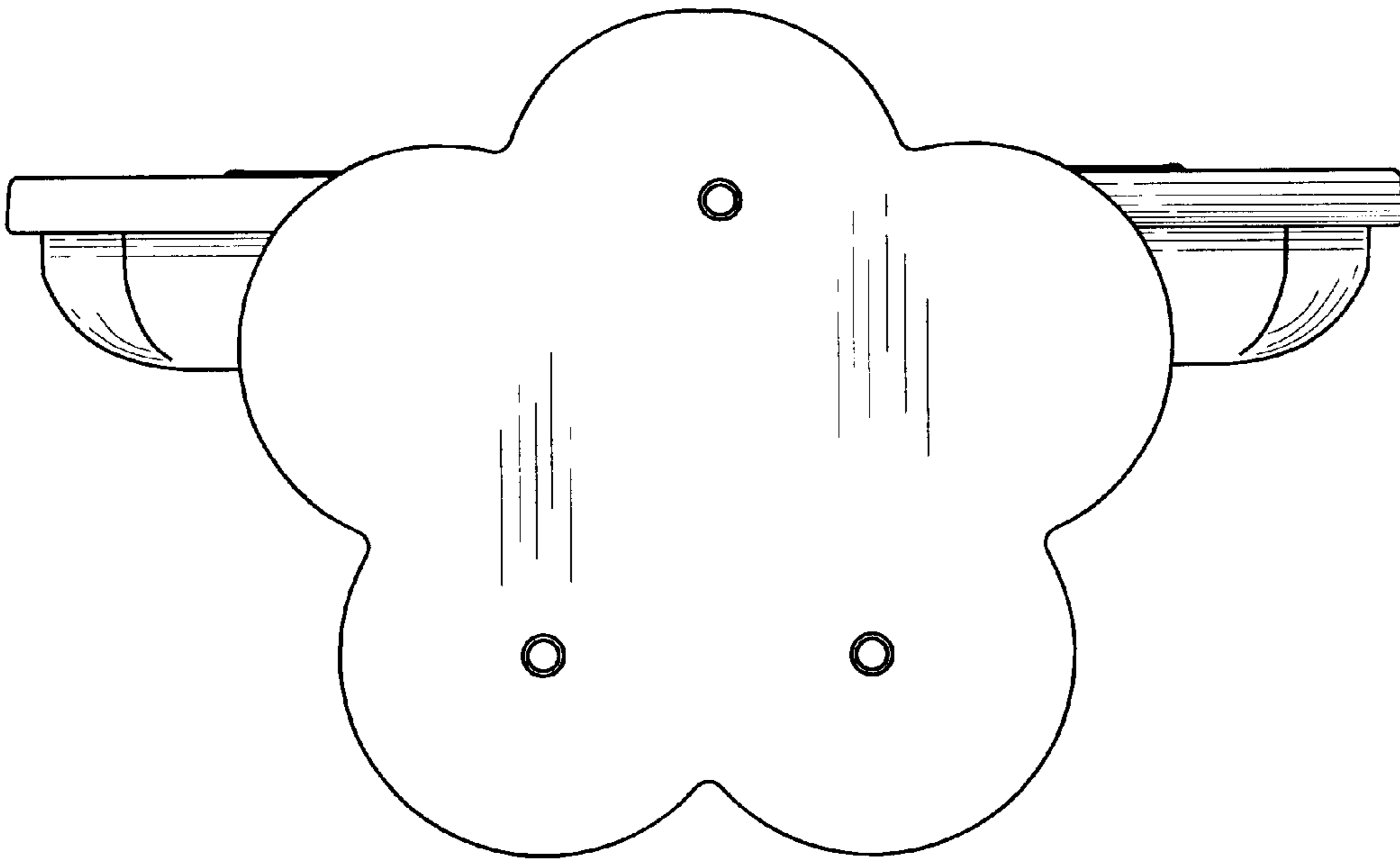

Fig. 5

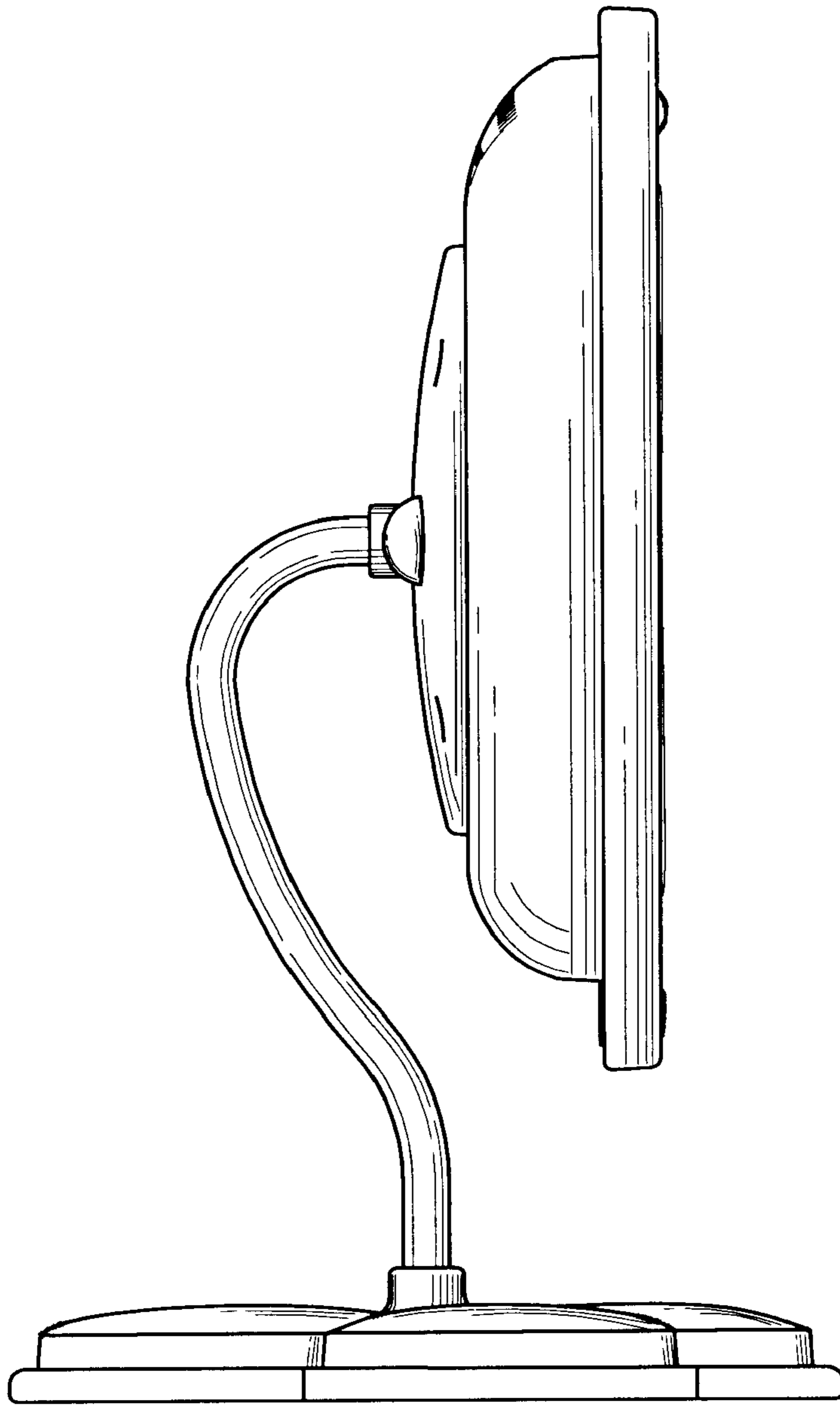

Fig. 6

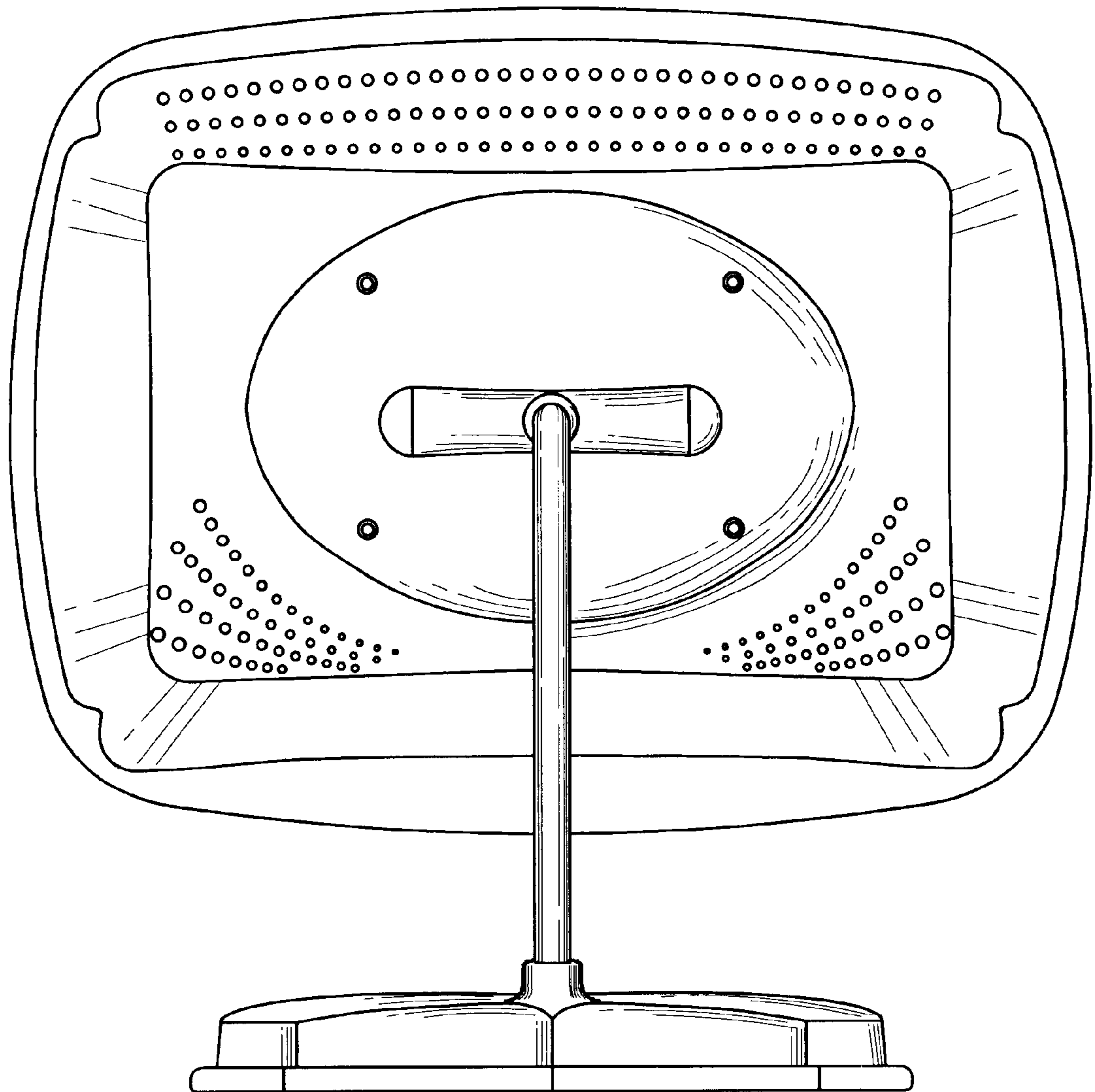

Fig. 7