



US00D488794S

(12) **United States Design Patent**
Chen

(10) **Patent No.:** **US D488,794 S**

(45) **Date of Patent:** **** Apr. 20, 2004**

(54) **CONFERENCE SPEAKERPHONE**

(75) **Inventor:** **Tonny Chen, Chang-Hua (TW)**

(73) **Assignee:** **E-Lead Electronic Co., Ltd.,
Chang-hua (TW)**

(**) **Term:** **14 Years**

(21) **Appl. No.:** **29/182,089**

(22) **Filed:** **May 21, 2003**

(51) **LOC (7) Cl. 14-03**

(52) **U.S. Cl. D14/150**

(58) **Field of Search D14/149-151,
D14/144, 243, 146, 130, 329, 330; 379/202.01,
420.01, 420.02, 420.03, 428.01, 428.02,
428.03, 419, 434, 436, 440**

(56) **References Cited**

U.S. PATENT DOCUMENTS

D342,732 S * 12/1993 Hinman et al. D14/150

D382,266 S * 8/1997 Wakefield D14/150

D478,560 S * 8/2003 Misrahi et al. D14/150

D481,371 S * 10/2003 Chen D14/150

* cited by examiner

Primary Examiner—Janice E. Seeger

(74) *Attorney, Agent, or Firm*—Troxell Law Office PLLC

(57) **CLAIM**

The ornamental design for a conference speakerphone, as shown and described.

DESCRIPTION

FIG. 1 is a perspective view of conference speakerphone showing my new design;

FIG. 2 is a front elevation view thereof;

FIG. 3 is a rear elevation view thereof;

FIG. 4 is a left side elevation view thereof;

FIG. 5 is a right side elevation view thereof;

FIG. 6 is a top plan view thereof; and,

FIG. 7 is a bottom plan view thereof.

1 Claim, 5 Drawing Sheets

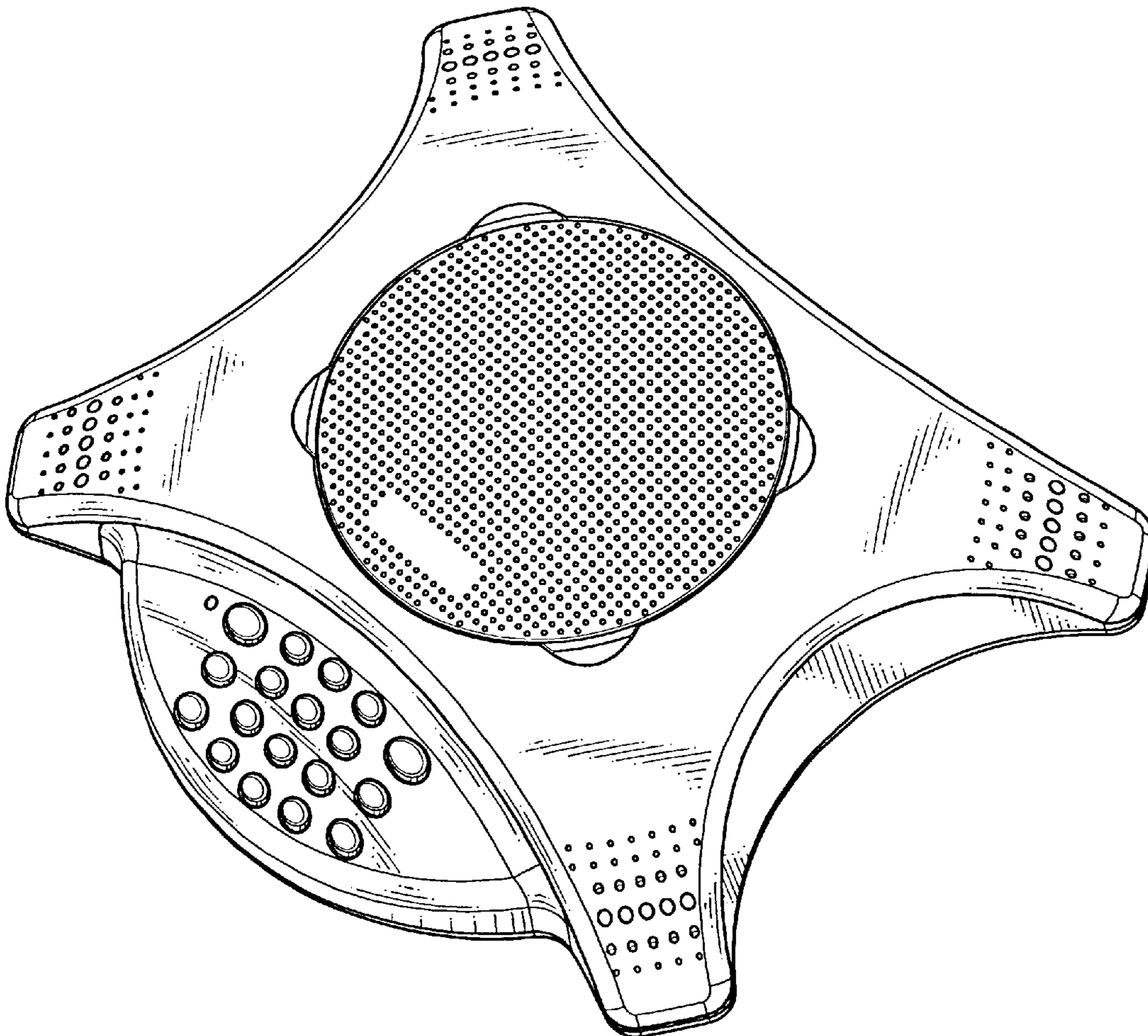

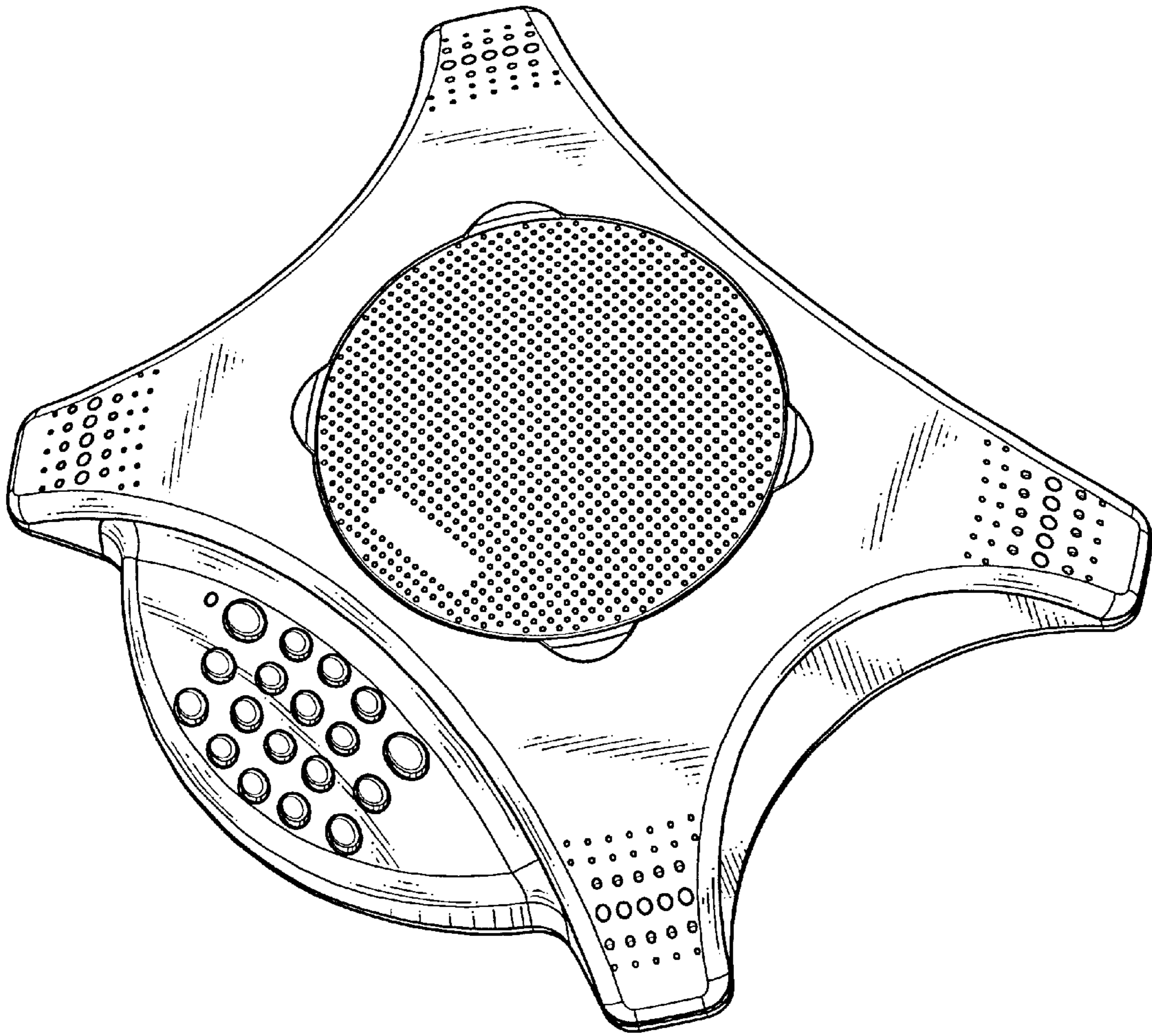

FIG.1

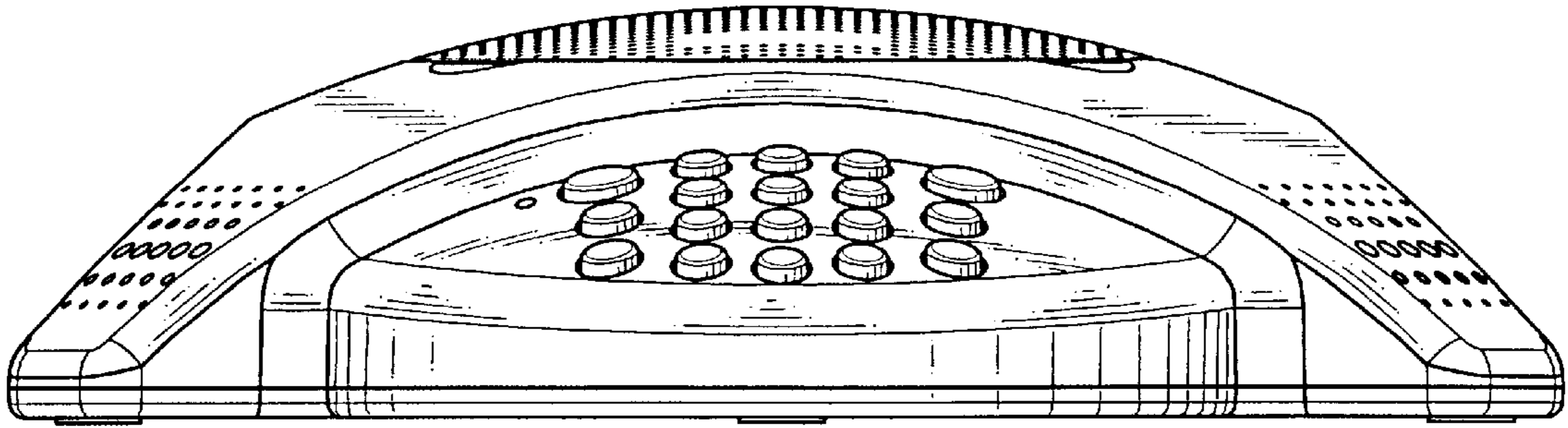

FIG. 2

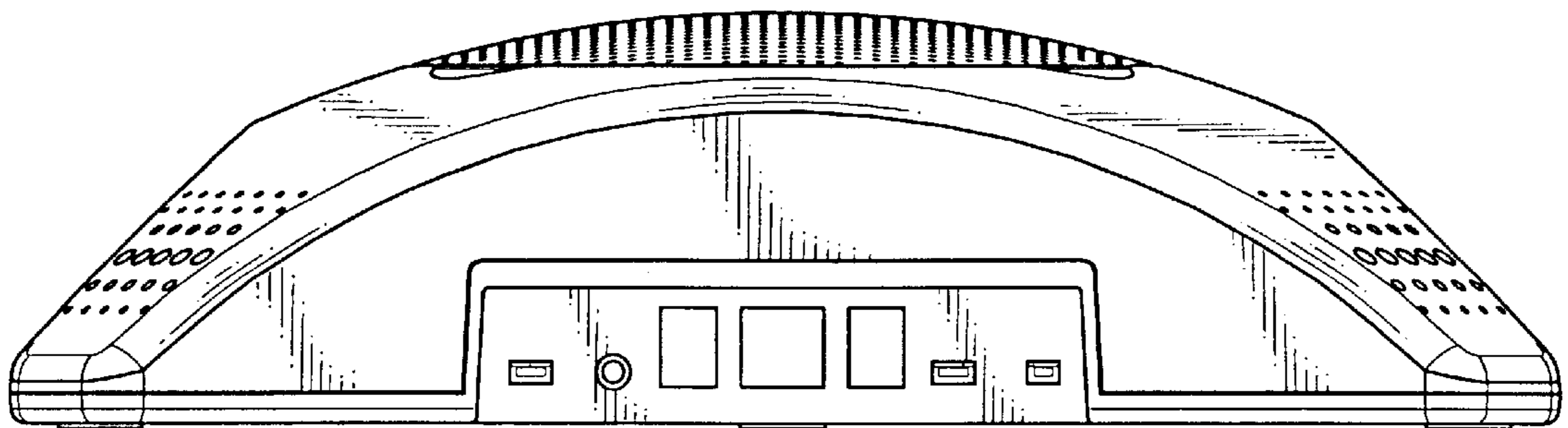

FIG. 3

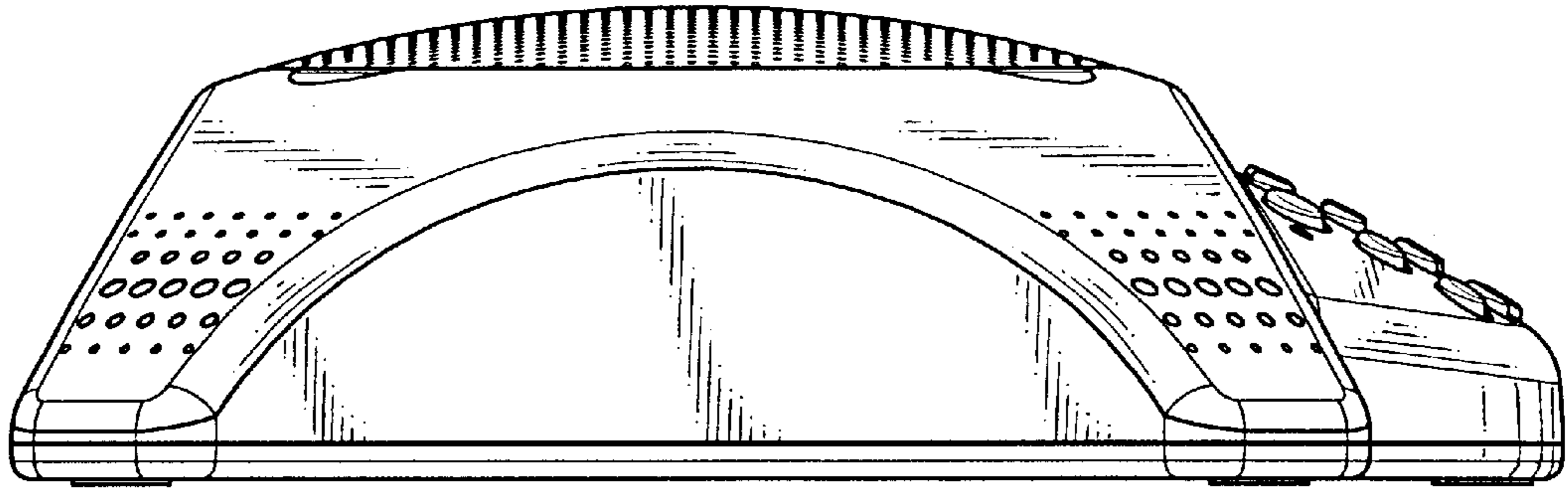

FIG. 4

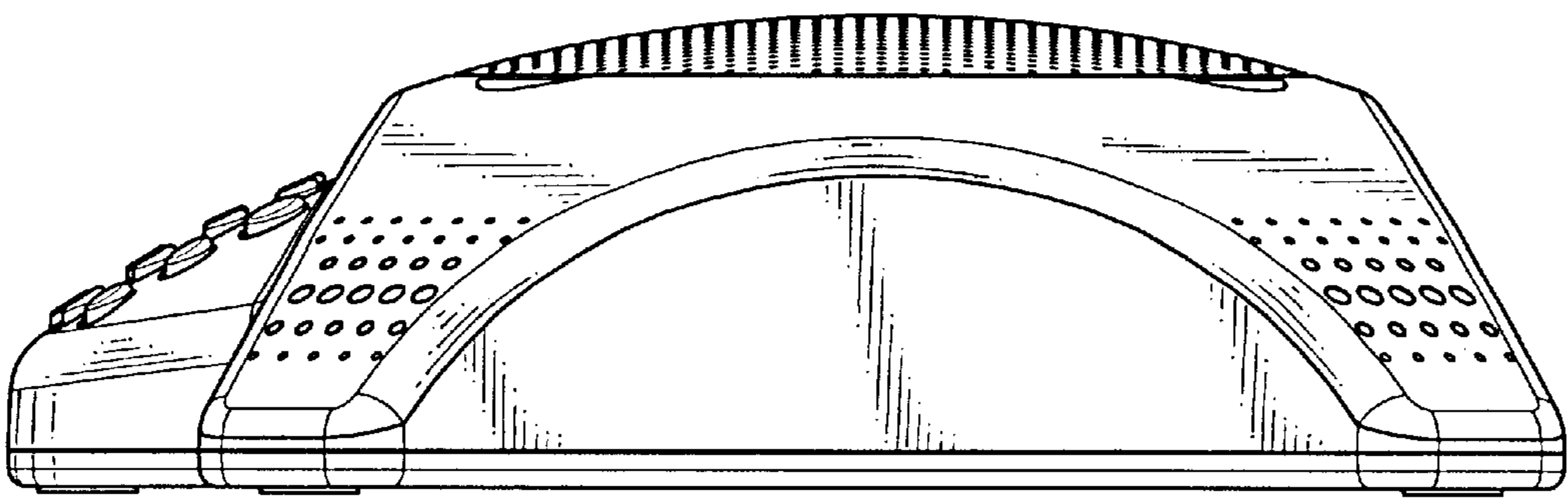

FIG. 5

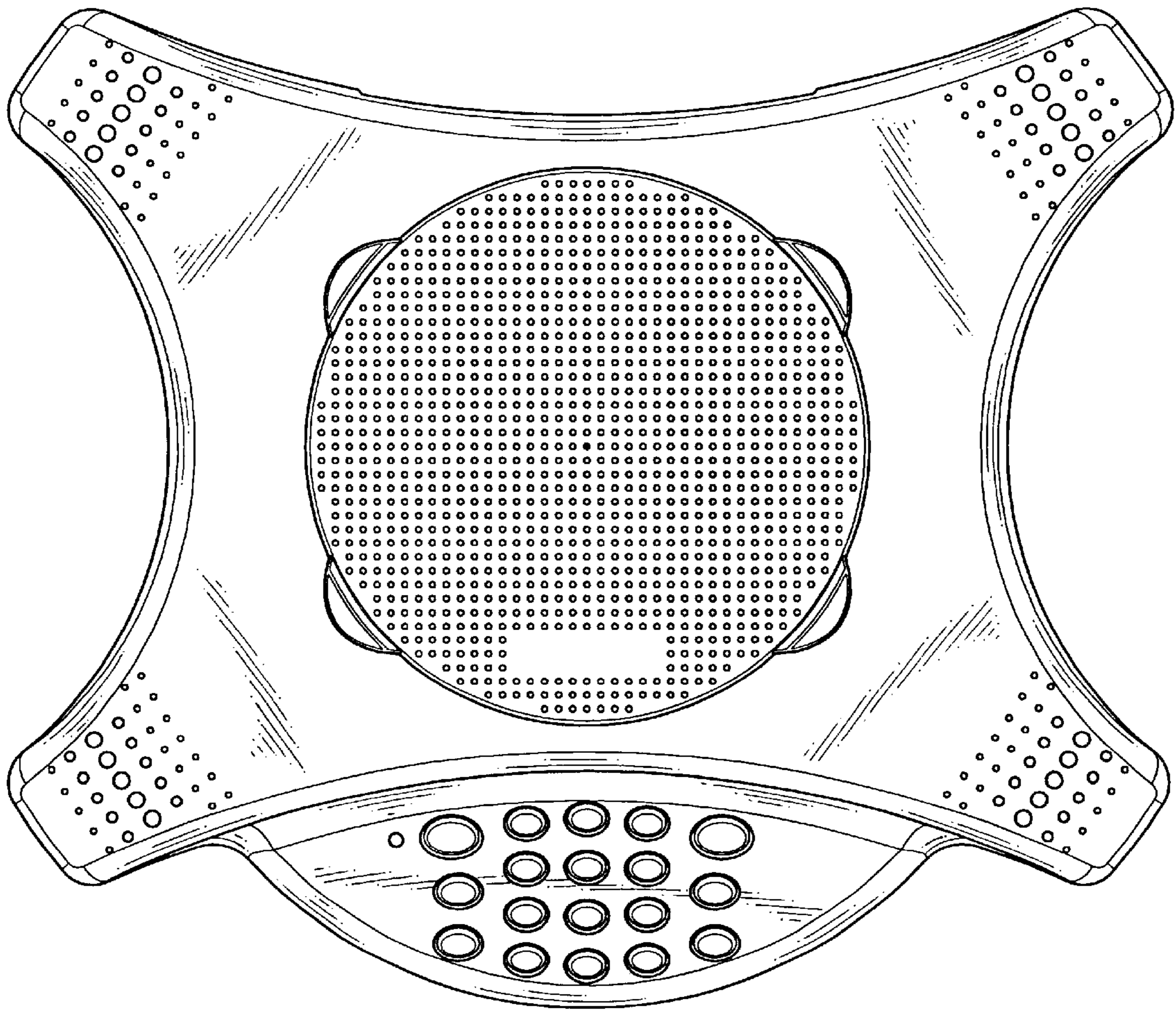

FIG.6

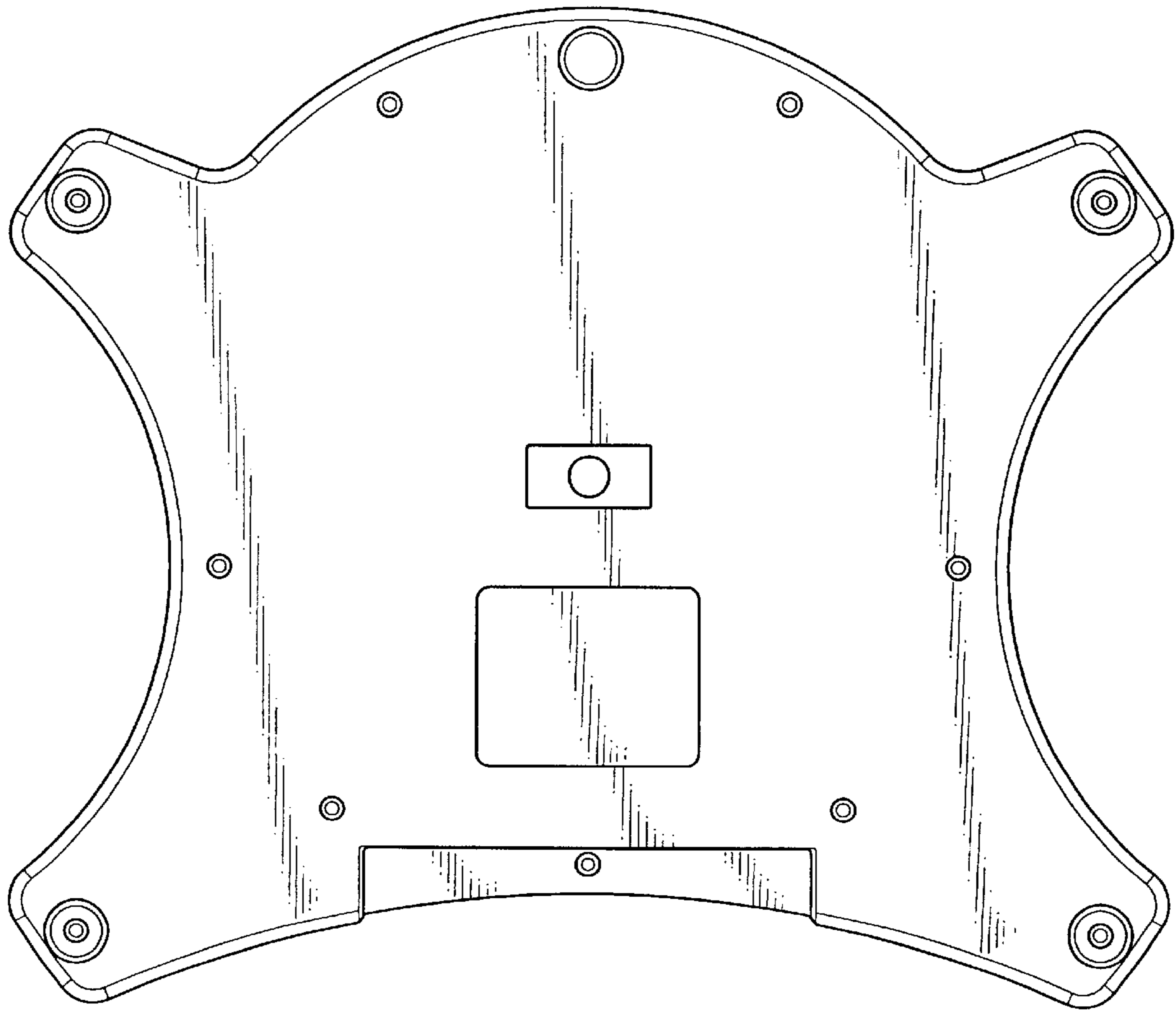

FIG.7