



US00D488681S

(12) **United States Design Patent**
Overthun et al.

(10) **Patent No.:** **US D488,681 S**

(45) **Date of Patent:** **** Apr. 20, 2004**

(54) **ZESTER**

D394,193 S * 5/1998 Deglon D7/693
D421,698 S * 3/2000 Wang D7/693

(75) Inventors: **Thomas Overthun**, San Francisco, CA (US); **Dana R. Nicholson**, San Francisco, CA (US); **James R. Yurchenco**, Palo Alto, CA (US); **Annetta M. Papadopoulos**, Palo Alto, CA (US)

* cited by examiner

Primary Examiner—Terry A. Wallace
(74) *Attorney, Agent, or Firm*—Snell & Wilmer LLP

(73) Assignee: **Zyliss USA Corp.**, Foothill Ranch, CA (US)

(57) **CLAIM**

The ornamental design for the zester, as shown.

(**) Term: **14 Years**

DESCRIPTION

(21) Appl. No.: **29/180,560**

FIG. 1 is a side perspective view of a zester showing an exemplary embodiment of our new design;

(22) Filed: **Apr. 25, 2003**

FIG. 2 is a left side view of the zester of FIG. 1;

(51) **LOC (7) Cl.** **07-04**

FIG. 3 is a right side view of the zester of FIG. 1;

(52) **U.S. Cl.** **D7/693**

FIG. 4 is a back view of the zester of FIG. 1;

(58) **Field of Search** D7/693, 688-695;
30/115, 278, 279.2, 279.4, 279.6

FIG. 5 is a front view of the zester of FIG. 1; and

FIG. 6 is a top view of the zester of FIG. 1; and,

FIG. 7 is a bottom view of the zester of FIG. 1.

(56) **References Cited**

U.S. PATENT DOCUMENTS

D161,534 S * 1/1951 Riley D7/693

1 Claim, 3 Drawing Sheets

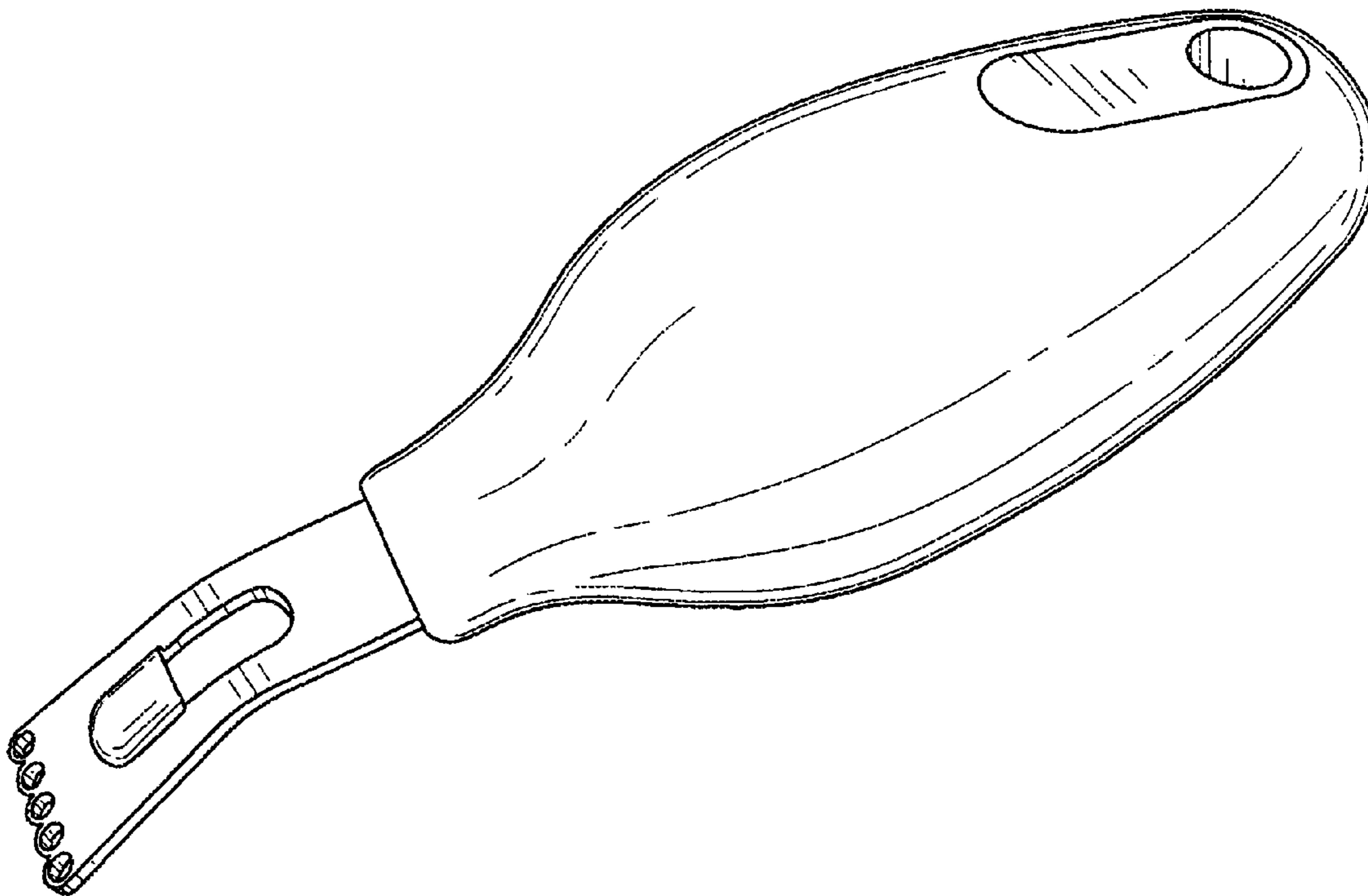

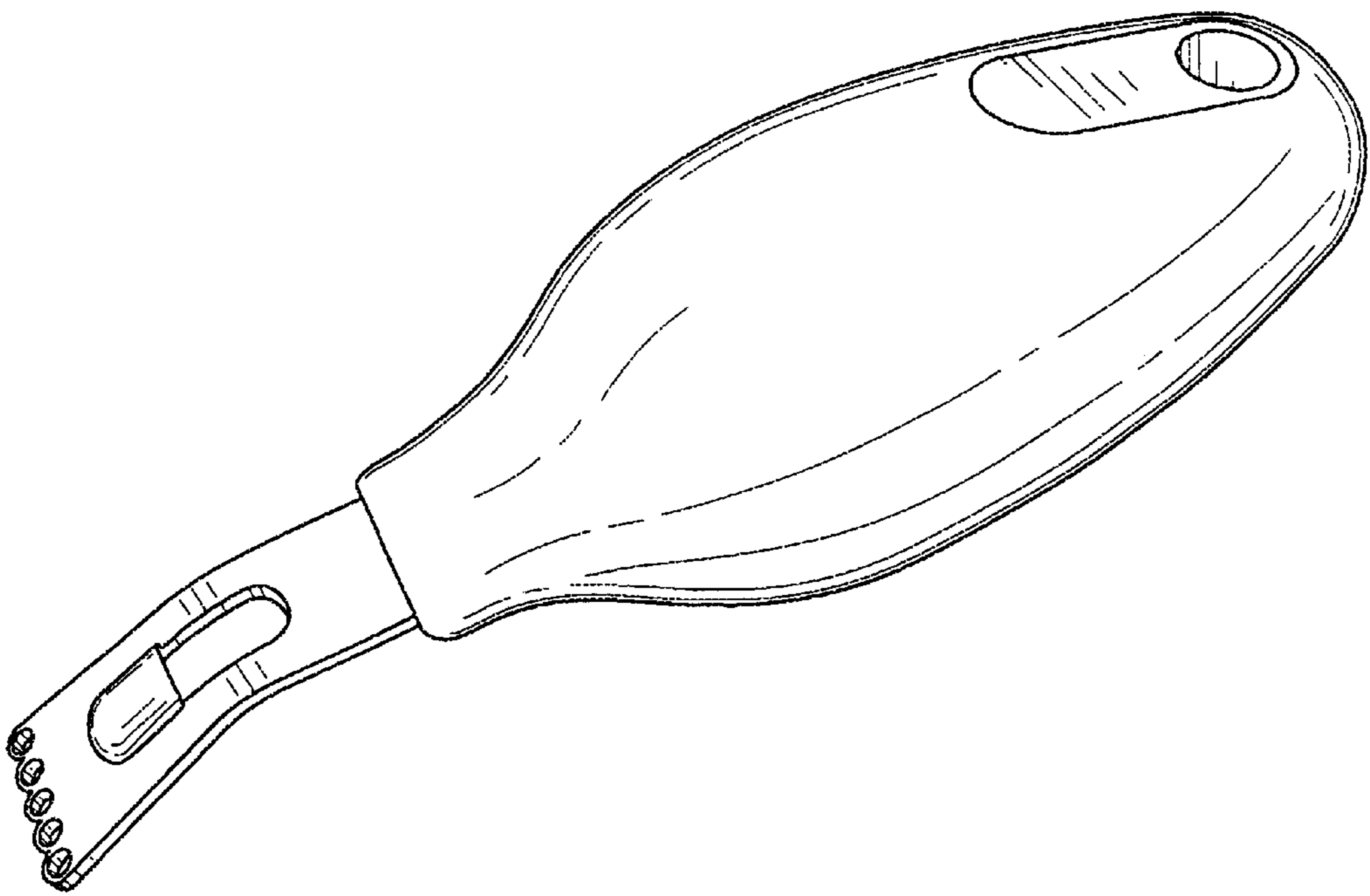

FIG. 1

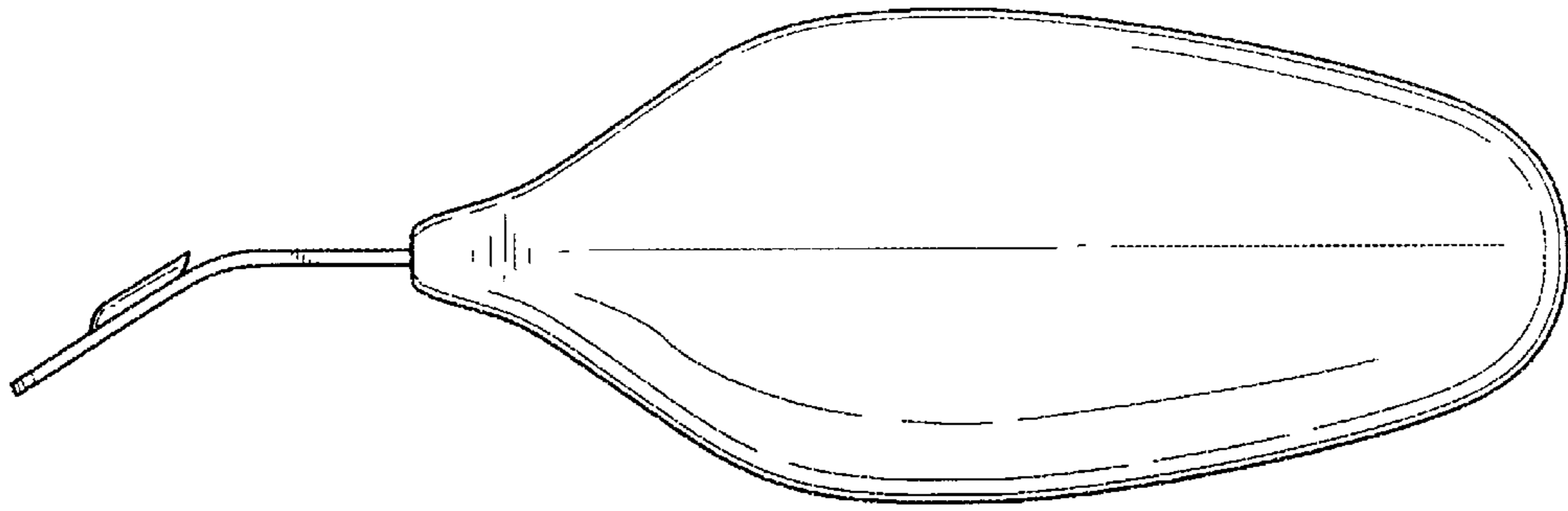

FIG.2

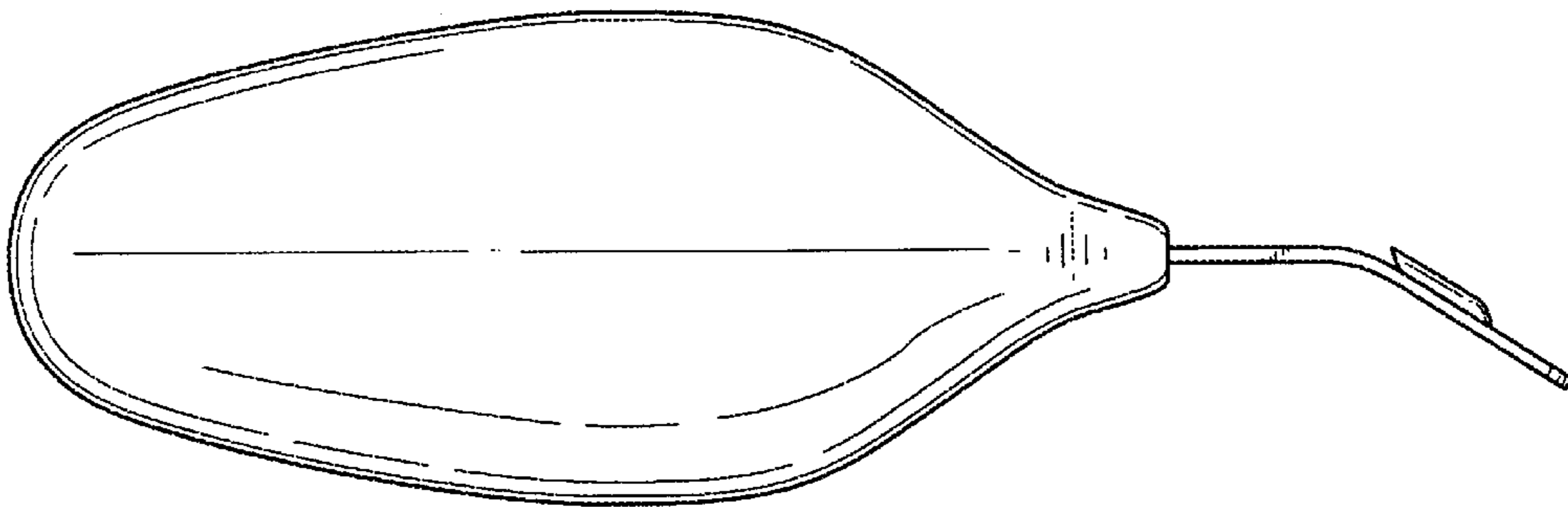

FIG.3

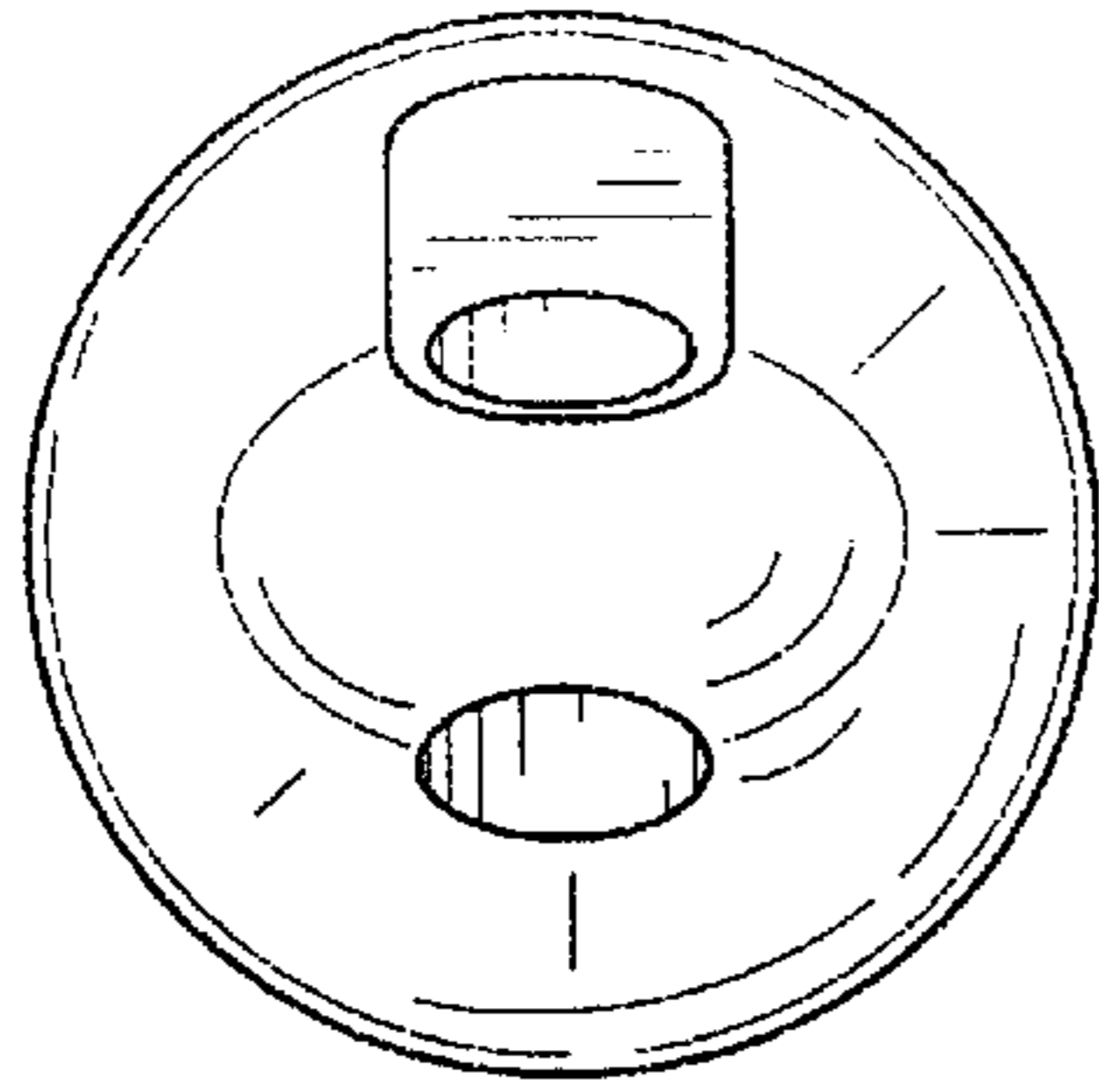

FIG. 4

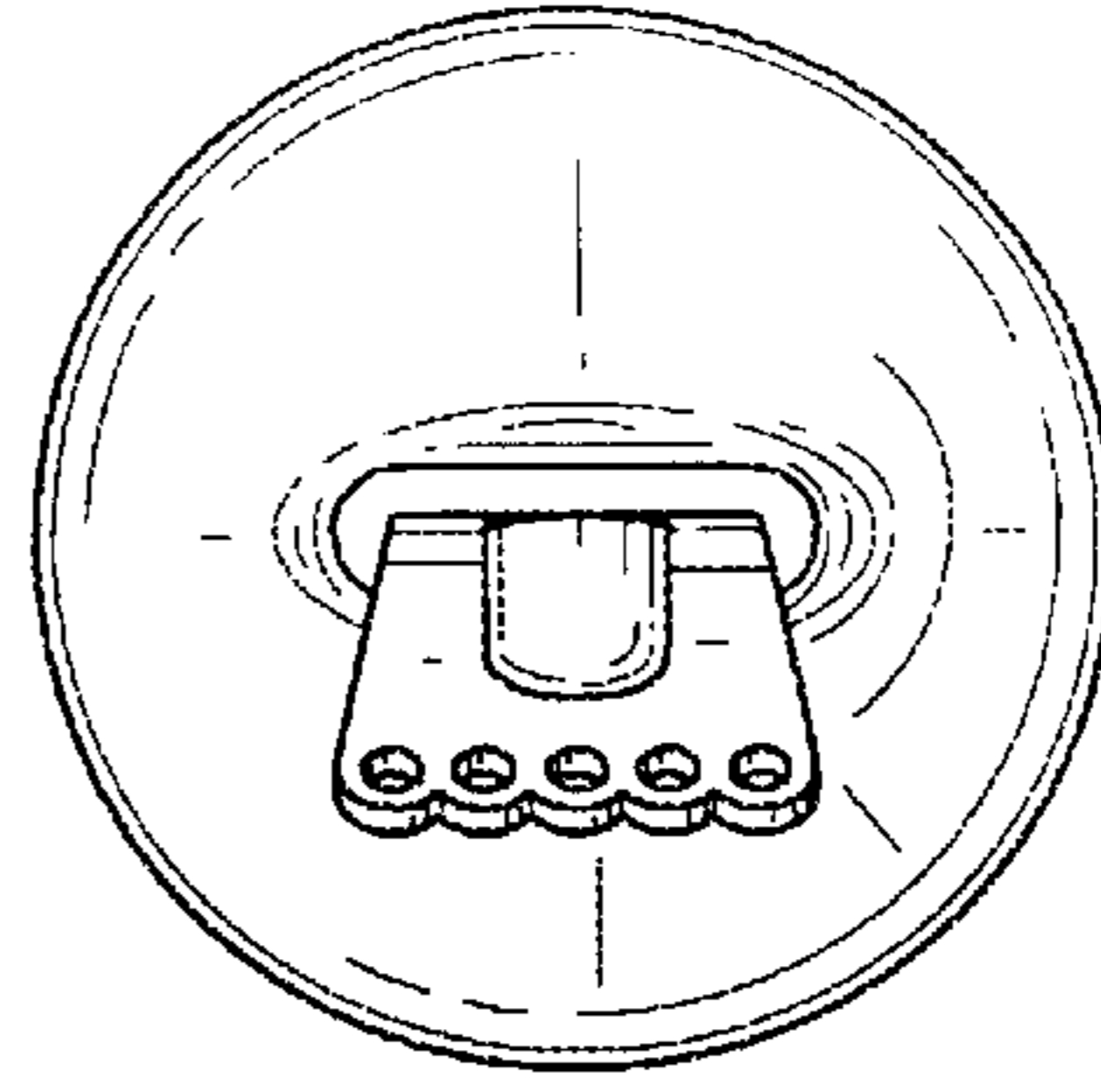

FIG. 5

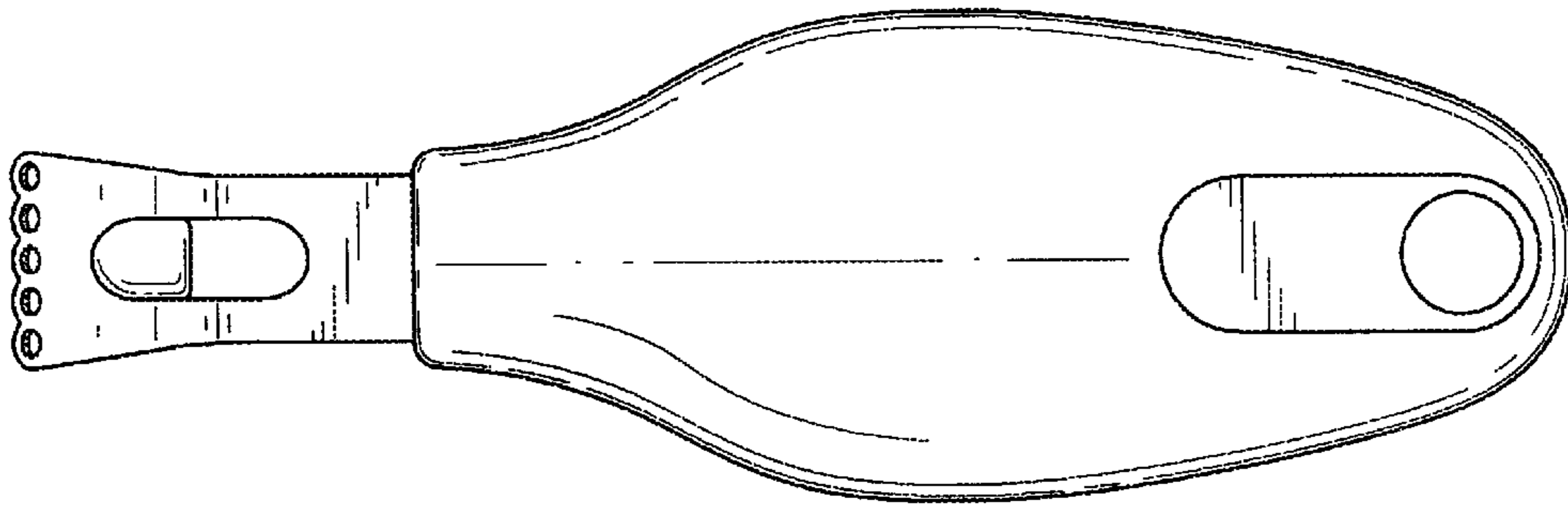

FIG. 6

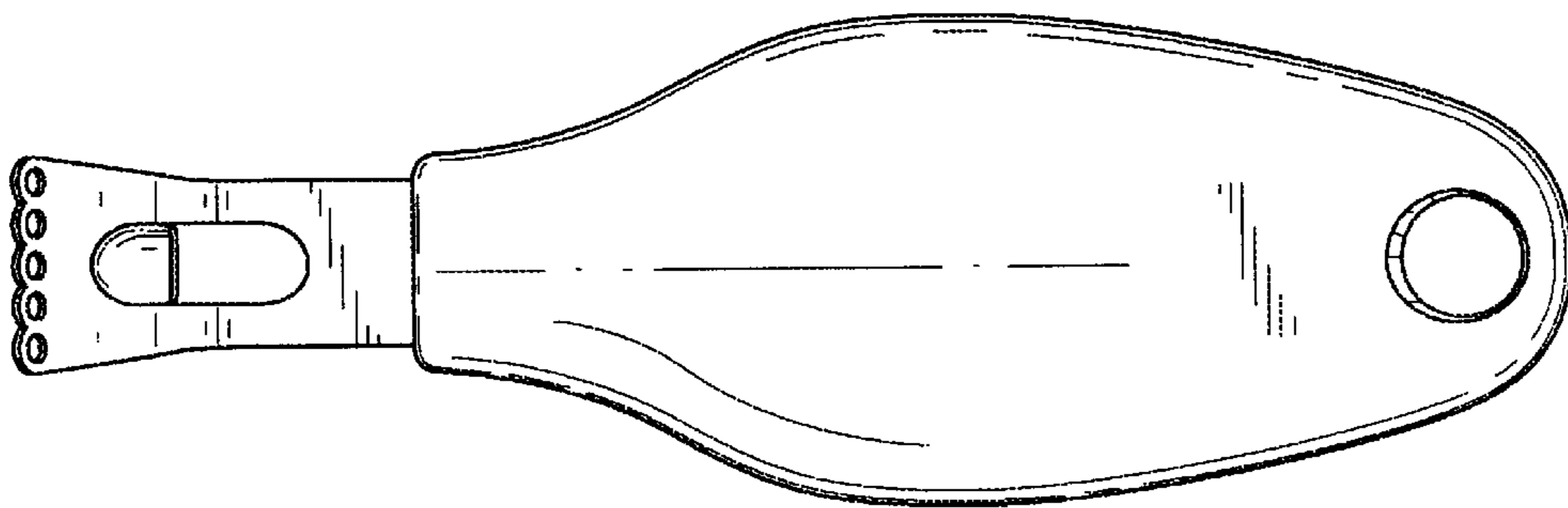

FIG. 7